

Poltrone

Armchairs

DITRE
italia

Armchairs

**Ditre
italia**

Poltroncine

Armchairs

—

_66_73



Bend

_14_23



Beyl

_152_157



Cart

_92_101



**Chloè &
Chloè luxury**

_120_129



**Claire &
Claire swivel**

_158_163



Class

_56_65



Cut

_82_91



Daytona

_142_147



Duffiè

_134_137



Ellie

Poltroncine

Armchairs

—

_148_151



Hug

_130_133



Jen

_74_81



Kyo

_110_119



Linear

_24_35



Lucia

_06_13



Nathy

_138_141



Ray

_44_55



Round

_36_43



Softy

_102_109



St.Tropez



design *Gabriele e Oscar Buratti*

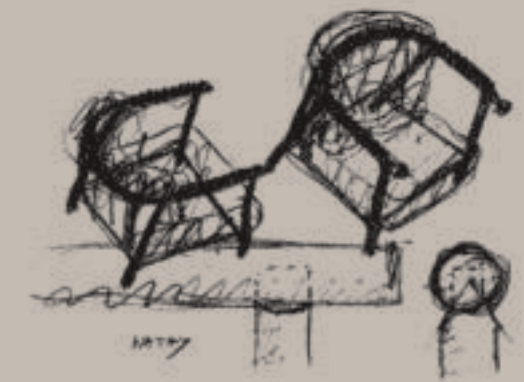
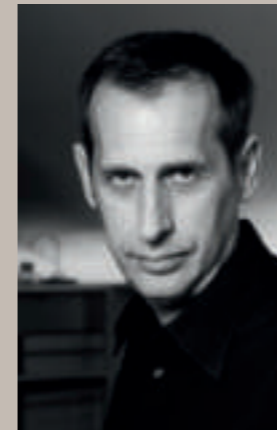

Nathy

Paired with sofas arranged into an island to favour conversation, or standing by itself next to a coffee table for a comfortable read, Nathy is always an iconic presence on the domestic scene. Sheets of natural leather are stretched over the wooden frame of the armchair to define and contain the shape of the soft, wraparound seat and backrest cushions.

Im Doppelpack oder einzeln, mit einem oder mehreren Sofas in der Plauderecke, mit einem Beistelltisch für die behagliche Lesestunde ... Nathy wird stets zum Kultobjekt der häuslichen Szene. Die Struktur aus Holz ist teilweise mit Stücken aus Naturleder bespannt, die die Formen nachzeichnen und den weichen bequemen Kissen der Sitzfläche und der Rückenlehne Halt geben.

Utilisé seul, ou par deux, en renfort des canapés dans les espaces de conversation, avec une table basse pour se plonger dans la lecture, le fauteuil Nathy est une présence iconique de l'espace domestique. Sur la structure en bois, on a tendu des feuilles de cuir naturel qui dessinent les formes et qui soutiennent les coussins moelleux et enveloppants de l'assise et du dossier.

In coppia o singola, con i divani nelle isole di conversazione, con un tavolino per immergersi nella lettura, Nathy è presenza iconica della scena domestica. Sulla struttura in legno sono tesi fogli di cuoio naturale che disegnano le forme e contengono i cuscini morbidi e avvolgenti di seduta e schienale.

Poltrona
l w 72 p d 86 h 62

Armchair
Sessel
Fauteuil









design **Gabriele e Oscar Buratti**

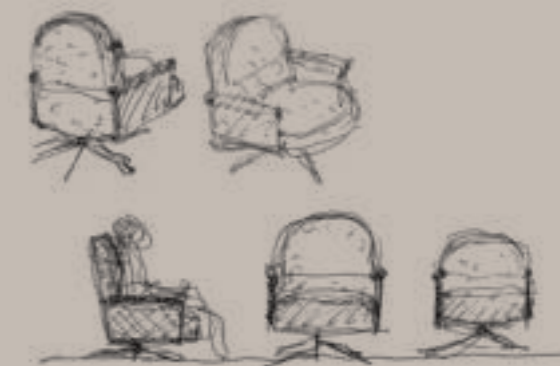

Beryl

An armchair is a private, personal space, the perfect choice when you want to spend some time all by yourself, relaxing between two armrests, stretching your body out and letting your head be supported by a headrest. Sink into its warm embrace; the rounded shape of its backrest and the refined design of its leather armrests inspired by the Althon sofa make for a very tasteful and elegant armchair. The two different heights of the backrest classify it under the category of the classic bergère chair or, in the lower version, as a lounge chair.

Der Sessel als privater, persönlicher Rückzugsort, um sich zwischen den Armlehnen zu entspannen, den Körper auszustrecken, den Kopf bequem abzustützen und sich ganz dem heimeligen Gefühl der Geborgenheit hinzugeben. Die abgerundete Form der Rückenlehne und die Ausgesuchtheit der vom Sofa Althon inspirierten Armlehnen aus Leder führen zu einem sehr raffinierten und eleganten Sessel. Die beiden unterschiedlichen Höhen der Rückenlehne zeigen sich beim klassischen Bergère-Sessel und bei der Variante des niedrigeren Loungessels.

Le fauteuil est un espace privé et personnel afin de s'isoler et de se relaxer entre deux accoudoirs, de détendre le corps et de poser la tête, pour un confort accueillant et enveloppant. La forme arrondie du dossier et l'aspect recherché des accoudoirs en cuir s'inspirant du canapé Althon caractérisent ce fauteuil raffiné et élégant. Les deux différentes hauteurs du dossier permettent de le décliner soit en une bergère classique soit en un fauteuil de relaxation.

La poltrona è spazio privato e personale, per isolarsi e rilassarsi tra due braccioli, per distendere il corpo e appoggiare la testa, per farsi accogliere e avvolgere. La forma arrotondata dello schienale e la ricercatezza dei braccioli in cuoio ispirati al divano Althon, connotano una poltrona molto ricercata ed elegante. Le due diverse altezze dello schienale la declinano nella classica poltrona bergère e nella variante poltrona lounge, più bassa.

Poltrona
l w 74 p d 83 h 96

Armchair
Sessel
Fauteuil





Beyl high
l w 74 p d 83 h 96



Beyl low
l w 74 p d 83 h 80







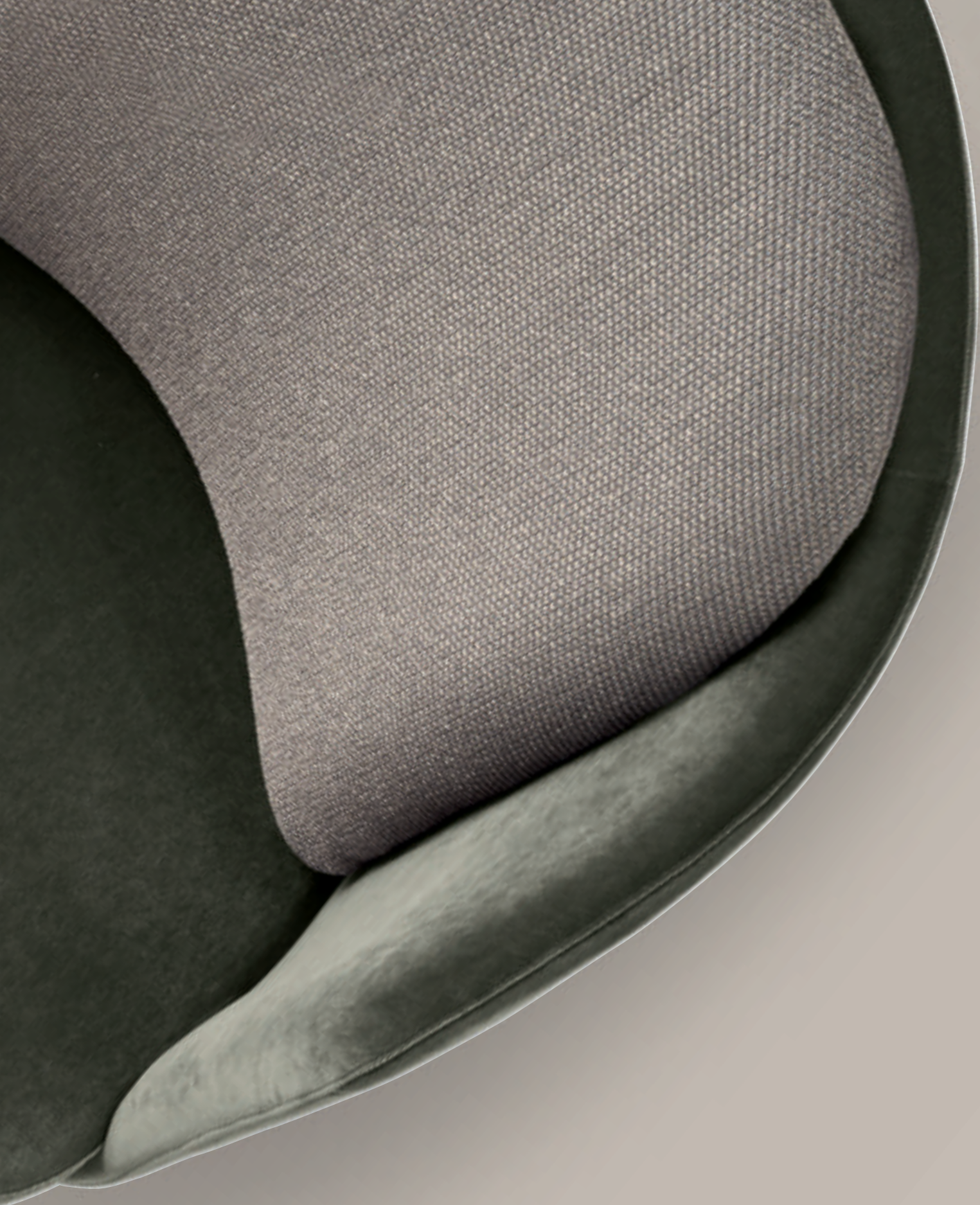

design *Federica Biasi*



Lucia

Elegance and femininity create a perfect synthesis of curves and details. Lucia is designed to add a touch of graceful elegance to living rooms while preserving its timeless, understated appeal. Its warm embrace is available in two versions, with a high or low backrest.

Eleganz und Femininität schaffen eine perfekte Übereinstimmung zwischen Kurven und Details. Das Modell Lucia soll dem Wohnraum eine anmutige Note verleihen, dabei aber dennoch ein nüchternes und zeitloses Aussehen bewahren. Eine weiche Umarmung, die in zwei Versionen mit hoher oder niedriger Rückenlehne erhältlich ist.

L'élégance et la féminité de ce modèle créent une parfaite harmonie de courbes et de détails. Le fauteuil Lucia a été créé pour apporter une touche de charme à son propre living, tout en gardant un aspect sobre et intemporel. Une assise moelleuse et enveloppante déclinable en deux versions : avec dossier haut ou bas.

Eleganza e femminilità creano una perfetta sintonia di curve e dettagli. Lucia nasce per dare un tocco aggraziato al proprio living, mantenendo un aspetto sobrio e senza tempo. Un morbido abbraccio declinabile in due versioni, con schienale alto e basso.

Poltrona
l w 76 p d 85 h 88

Armchair
Sessel
Fauteuil









Lucia high
l w 76 p d 85 h 88



Lucia low
l w 76 p d 85 h 81







design *Edi & Paolo Ciani*



Softy

This armchair has a strong visual impact that, at once, expresses solidity and softness. The metal base and its leather cover express a vintage soul, creating a pleasant contrast with the generous seat padding and producing interplays of different materials with very elegant results. It's the ideal chair to distinguish contemporary, emotive settings such as lounge areas, waiting rooms, cosy sitting areas and hotel lobbies.

Ein Sessel mit starker optischer Wirkung, der gleichzeitig Festigkeit und Weichheit ausdrückt. Das Grundgestell aus Metall und der äußere Bezug aus Leder bringen seine Vintage-Seele zum Vorschein und bilden einen angenehmen Kontrast zur großzügigen Polsterung der Sitzfläche, wodurch ein materielles Wechselspiel entsteht, das ihm große Eleganz verleiht. Die ideale Lösung, um zeitgenössische und oft auch emotionsgeladene Räumlichkeiten wie Lounge-Bereiche, Wartezimmer, gemütliche Sitzecken oder Hotellobbys einzurichten.

Un fauteuil au fort impact visuel qui exprime à la fois solidité et accueil moelleux. Le piètement en métal et le revêtement extérieur en cuir expriment son âme vintage et créent un agréable contraste avec le rembourrage généreux de l'assise, en créant des effets de matière qui lui donnent une grande élégance. La solution idéale pour caractériser des espaces contemporains et émotionnels, comme les salons bars, les salles d'attente, les salons de détente et de conversation ou les halls d'hôtel.

Una poltrona dal forte impatto visivo che esprime al tempo stesso solidità e morbidezza. Il basamento in metallo ed il rivestimento esterno in pelle esprimono la sua anima vintage e creano un piacevole contrasto con la generosa imbottitura della seduta dando vita ad un gioco di sensazioni materiche che le donano grande eleganza. La soluzione ideale per caratterizzare ambienti contemporanei ed emozionali come lounge areas, waiting rooms, cosy sitting areas e lobby d'albergo.

Poltrona
lw 80 pd 89 h 97

Armchair
Sessel
Fauteuil







Poltrona
lw 80 pd 89 h 97

Armchair
Sessel
Fauteuil



Poltrona
lw 80 pd 89 h 97

Armchair
Sessel
Fauteuil



Poltrona
lw 80 pd 89 h 97

Armchair
Sessel
Fauteuil



Round

The Round chair has a wraparound shape with imposing but extremely well-balanced proportions that give it a very cosy appeal. It is available leather or fabric upholstered or in the special mixed version featuring fabric and leather together.

Round ist ein Sessel mit weichen, einhüllenden Formen und eindrucksvollen, aber trotzdem ausgewogenen Proportionen, der sofort zum Ausruhen einlädt. Er kann mit Stoff oder Leder bezogen werden und steht auch in der Version „Mix“ aus Leder und Stoff zur Auswahl.

Round est un fauteuil aux formes enveloppantes, avec des proportions importantes, mais très équilibrées, qui donnent une forte sensation d'accueil. Il peut être revêtu soit en tissu soit en cuir et, dans la version « Mix », en tissu et en cuir.

Round è una poltrona dalle forme avvolgenti, di proporzioni importanti ma estremamente calibrate, che danno un forte senso di accoglienza. Può essere rivestita in tessuto o pelle e nella particolare versione "mix" con tessuto e pelle insieme.

Poltrona
l w 80 p d 88 h 96

Armchair
Sessel
Fauteuil





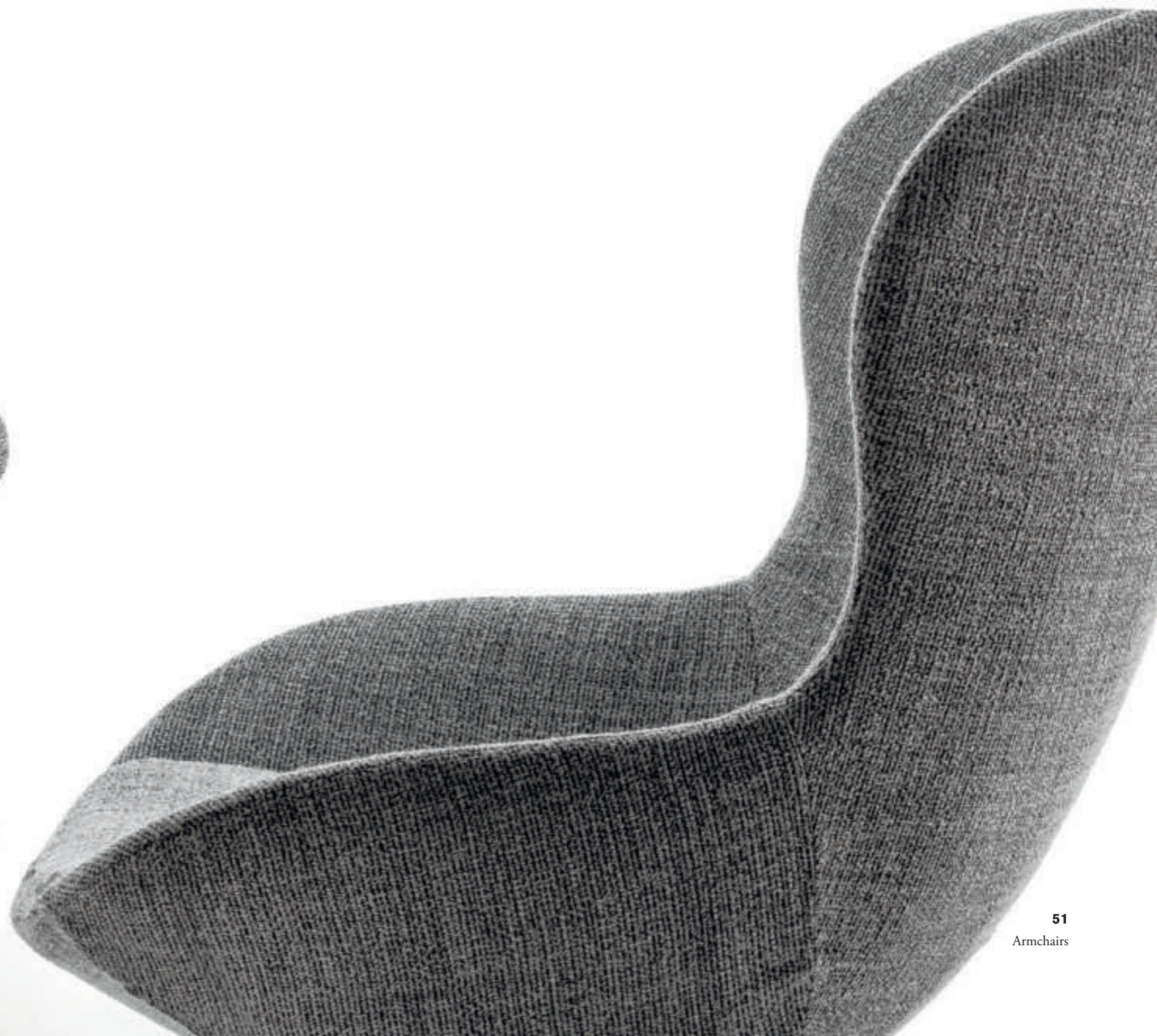



Round *Armchair*



Poltrona
l w 80 p d 88 h 96

Armchair
Sessel
Fauteuil



Poltrona
l w 80 p d 88 h 96

Armchair
Sessel
Fauteuil



Poltrona
l w 80 p d 88 h 96

Armchair
Sessel
Fauteuil

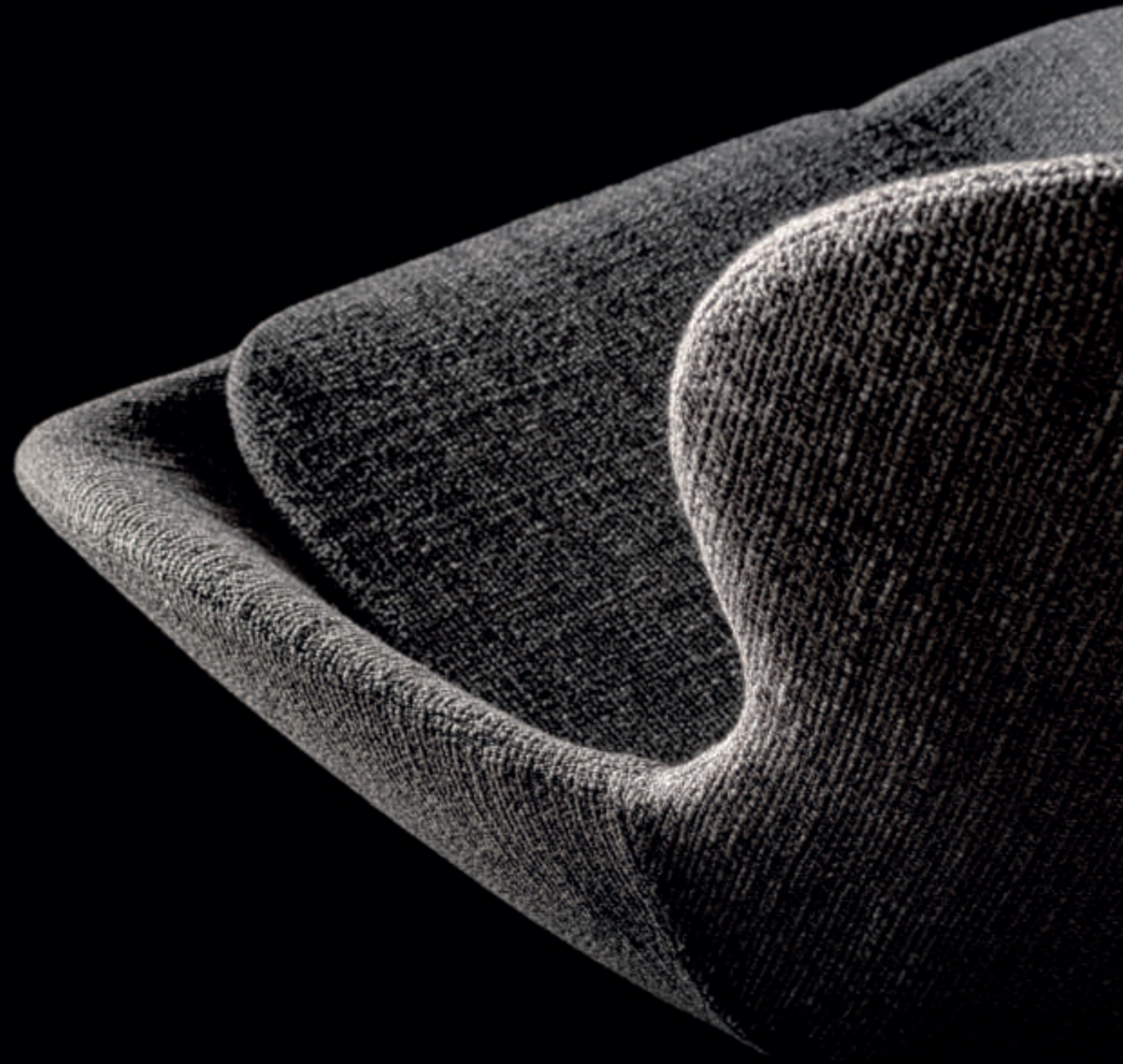



design *Daniela Lo Scalzo Moscheri*



Cut

Sartorial details become a project. The Cut armchair stands out for its discretion. Its harmonious lines reveal all the comfort enclosed in a moulded shell, interrupted by bold stitching that sets off its shape and divides its volumes. The armchair is designed as if it were a bag: at once functional yet elegant but, above all, able to mix and match with lots of different sofa models and types.

Ein Detail des Schneiderhandwerks wird zum Entwurf. Cut ist ein Sessel, der sich durch fehlenden "Geltungsdrang" auszeichnet. Der harmonische Umriss enthüllt die ganze Bequemlichkeit der fassonierten Sitzschale, die von tiefen durchgehenden Nähten unterbrochen wird, die die Form der Module nachzeichnen und unterbrechen. Der Sessel wird wie eine Handtasche interpretiert, die gleichzeitig zweckmäßig und elegant ist, aber vor allem immer zu den verschiedenen Arten und Modellen der Sofas passt.

Le détail digne de la haute couture devient projet. Cut, qui est un fauteuil qui ne veut pas avoir la vedette, se caractérise par des contours harmonieux dévoilant tout le confort renfermé dans une coque galbée dont les surpiqûres servent à la fois à tracer et à interrompre les volumes.

Le fauteuil est interprété comme un sac à main, à la fois fonctionnel et élégant, mais surtout pouvant s'associer aux différents types et modèles de canapés.

Il dettaglio sartoriale diventa progetto. Cut è una poltrona caratterizzata da una "assenza" di protagonismo, dove l'outline armonico svela tutta la comodità racchiusa in un guscio sagomato interrotto da cuciture passanti che ne accennano ed interrompono i volumi. La poltrona è interpretata come una borsa, funzionale ed elegante allo stesso tempo, ma soprattutto accostabile alle varie tipologie e modelli di divani.

Poltrona
l w 75 p d 84 h 113

Armchair
Sessel
Fauteuil







Pouff
l w 61 p d 44 h 38

Footstool
Hocker
Pouf



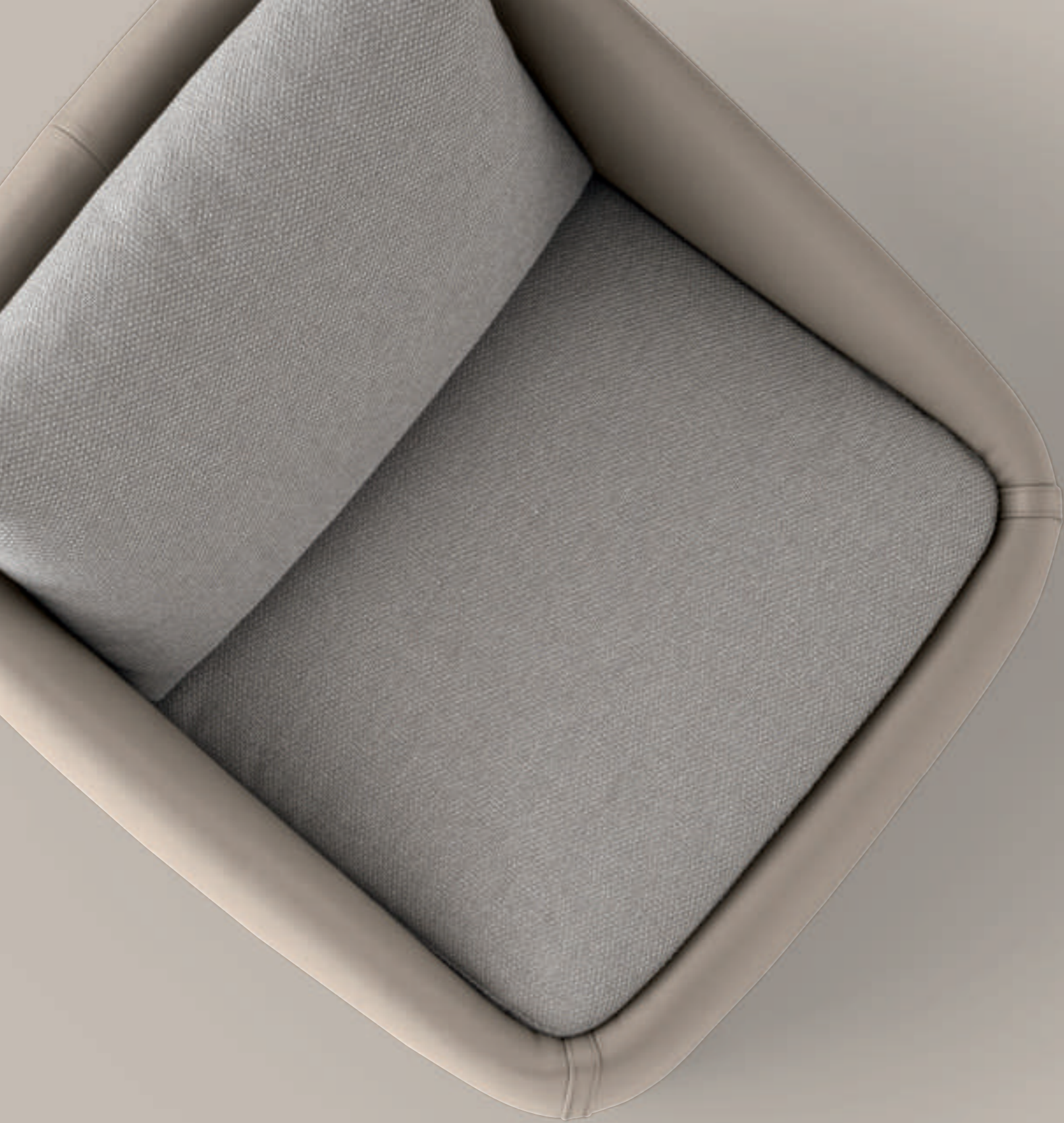

design *Daniela Lo Scalzo Moscheri*



Bend

The act of transforming a simple shape into comfortable seating by removing some of its aesthetic parts makes Bend a recognisable yet unobtrusive object. Its soft shapes connect the bold, square volumes of its vertical surfaces. But Bend also displays sartorial details: the corners are made of vertical fabric or leather strips sewn on with double hems.

Die Umwandlung einer einfachen Form in ein bequemes Sitzmöbel durch einen Prozess der ästhetischen Reduktion macht Bend zu einem wiedererkennbaren, aber nicht aufdringlichen Objekt. Seine weichen Formen verbinden die quadratischen und markanten Module der senkrechten Flächen. Bend ist auch ein Meisterwerk der Schneiderkunst: Seine Eckkanten sind mit senkrechten, doppelt vernähten Bändern aus Stoff oder Leder ausgeführt.

Transformer une forme simple en un élément confortable à travers un processus de soustraction esthétique permet au fauteuil Bend de devenir un objet reconnaissable, mais pas envahissant. Ses formes douces se raccordent aux lignes droites et sobres des surfaces verticales. Bend est aussi un produit où la couture joue son rôle : en effet, les angles sont réalisés avec des bandes verticales cousues avec un double revers en tissu ou en cuir.

Trasformare una forma semplice in un prodotto comodo con un processo di sottrazione estetica rende Bend un oggetto riconoscibile, ma non invasivo. Le sue forme morbide ricordano i volumi squadrati e decisi delle superfici verticali. Bend è anche un manufatto sartoriale: infatti gli angoli sono realizzati con fasce verticali cucite con doppio risvolto di tessuto o pelle.

Poltrona

lw 84 pd 91 h 92

Armchair

Sessel

Fauteuil





Bend high
lw 84 pd 91 h 92



Bend low
lw 84 pd 91 h 74







design Stefano Spessotto & Lorella Agnoletto

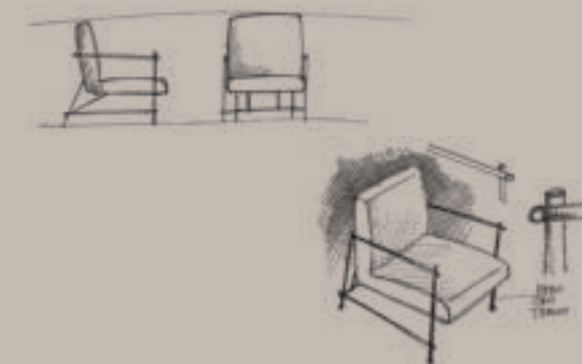

Kyo

The seat and backrest are practically suspended, supported by a slim frame in metal. An object that can add a unique touch to any setting, be it a living room or a public place. Lots of upholsteries are available for it on catalogue.

Sitzfläche und Rückenlehne schweben scheinbar im Raum und werden nur von einer schlanken Metallstruktur. Ein Objekt, das jedem Ambiente Einzigartigkeit verleiht, ganz gleich, ob es sich um das eigene Wohnzimmer oder einen öffentlichen Raum handelt. Der Katalog enthält eine große Auswahl von Bezügen.

L'assise et le dossier sont pratiquement suspendus, supportés par une fine structure en métal. Un objet à même d'apporter un caractère unique au mobilier tant d'un salon d'habitation que d'un espace public. Proposé dans de nombreux revêtements au choix.

Seduta e schienale praticamente sospesi, sorretti da una sottile struttura in metallo. Un oggetto in grado di imprimere unicità all'ambiente di arredo, sia esso il living di casa o uno spazio pubblico. Molti i rivestimenti a catalogo.

Poltrona
l w 77 p d 88 h 79

Armchair
Sessel
Fauteuil







Finitura
Black

Finishing
Ausführung
Finition



Finitura
Light Brown

Finishing
Ausführung
Finition



Finitura
Gold

Finishing
Ausführung
Finition





design *Daniela Lo Scalzo Moscheri*

Daytona

With its metal frame and its wooden armrests, Daytona is the perfect armchair for important places. Both the bedroom and the living will be enhanced by the unmistakable personality of this masterpiece.

Die Struktur aus Metall wird durch Armlehnen aus Holz verschönt, wodurch Daytona der passende Sessel für bedeutende Räumlichkeiten ist. Jeder Schlaf- oder Wohnbereich erhält durch dieses Modell mit unverwechselbarem Charakter eine besondere Note.

Doté d'une structure en métal enrichie d'accoudoirs en bois, Daytona est le fauteuil pour tous les espaces importants. La chambre ou le living seront revalorisés par cette pièce au caractère sans égal.

Struttura in metallo impreziosita dai braccioli in legno, Daytona è la poltrona per tutti gli ambienti importanti. Zona notte o living saranno rivalutati da questo pezzo dal carattere inconfondibile.

Poltrona
l w 69 p d 80 h 73

Armchair
Sessel
Fauteuil









Daytona *Armchair*



design Stefano Spessotto & Lorella Agnoletto

Chloè

Softly padded round shapes for an armchair that becomes a cosy nest. Its informal nature is enhanced by edges in a contrasting colour.

Sanfte und weich gepolsterte Rundungen für diesen Stuhl, der zum einladenden Nest wird. Der zwanglose Charakter wird durch die Einfassung in Kontrastfarbe zusätzlich betont.

Formes arrondies et moelleusement rembourrées pour un fauteuil qui devient un nid accueillant. Le caractère informel est souligné par le passepoil décliné dans une teinte contrastante.

Sagome rotonde e morbidamente imbottite, per una poltroncina che diventa un nido accogliente. Il carattere informale è sottolineato dal bordo con colore in contrasto.

Poltrona
l w 74 p d 71 h 71

Armchair
Sessel
Fauteuil

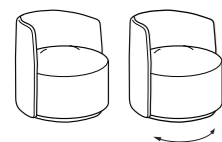

Pouff
l w 55 p d 55 h 44

Footstool
Hocker
Pouf



Chloè

Luxury

The soft, rounded shapes of this armchair are embellished behind the backrest by elegant and refined pleating, reminiscent of bygone days. An Art Decò yet contemporary armchair that perfectly furnishes any type of setting.

Die weichen, rundlichen Formen des kleinen Sessels werden durch eine elegante und raffinierte Bearbeitung auf der Rückseite der Lehne verschönt, die an die Atmosphäre vergangener Zeiten erinnert. Ein Sitzmöbel im Decò-Stil und trotzdem modern, mit dem sich jede Art von Raum einrichten lässt.

Les formes douces et arrondies de ce fauteuil sont enrichies, au dos du dossier, par un plissé élégant et raffiné qui évoque des atmosphères d'antan. Un élément à la fois déco et contemporain, à même de meubler n'importe quel type d'espace intérieur.

Le forme morbide e rotonde della poltroncina vengono impreziosite da una lavorazione elegante e raffinata sullo schienale che evoca atmosfere di altri tempi. Un elemento decò e allo stesso tempo contemporaneo capace di arredare ogni tipologia di ambiente.

Poltrona
l w 74 p d 71 h 71

Armchair
Sessel
Fauteuil

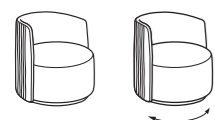





design *Daniele Lo Scalzo Moscheri*

St. Tropez

This elegant armchair in the dual front-back coloured version has an impressive base in solid wood. With its comfortable and slightly over-sized seat, the St. Tropez sofa has been designed for important moments: those dedicated to relaxation.

Ein eleganter Sessel in der Version mit zweifarbiger Rückenlehne und starkem Untergestell aus massivem Holz. Die bequeme, etwas tiefere Sitzfläche machen St. Tropez zu einem Sessel für wichtige Momente und erholsame Augenblicke.

Fauteuil élégant dans sa version bicolore, supporté par un important piètement en bois massif. Doté d'une assise confortable et légèrement plus large, St. Tropez est le fauteuil des grands moments : ceux consacrés à la détente.

Poltrona elegante nella versione bicolore fronteschienale, porta un importante basamento in legno massello. Seduta comoda e leggermente maggiorata, St. Tropez è la poltrona dei grandi momenti, quelli dedicati al relax.

Poltrona
l w 80 p d 83 h 76

Armchair
Sessel
Fauteuil









design *Edi & Paolo Ciani*

Linear

The Linear chair brings to mind classic shapes, made over in a modern key. The wrap around seat and the tall backrest make it very comfortable. Available with a swivel base in metal or in wood.

Der Sessel Linear zeigt sich mit Linien und Formen der Vergangenheit, die auf moderne Weise überarbeitet wurden. Die einhüllende Schale und die hohe Rückenlehne machen das Modell ausgesprochen bequem. Erhältlich mit drehbarem Untergestell aus Metall oder mit Untergestell Holz.

Le fauteuil Linear évoque des lignes et des formes du passé, revisitées en style contemporain. La coque enveloppante et le dossier haut le rendent extrêmement confortable. Disponible avec piètement pivotant en métal ou bien avec piètement en bois.

La poltrona Linear rievoca linee e forme del passato, riviste in chiave moderna. Il guscio avvolgente e lo schienale alto la rendono estremamente comoda. Disponibile con basamento girevole in metallo oppure basamento in legno.

Poltrona
l w 73 p d 75 h 99

Armchair
Sessel
Fauteuil





Poltrona
l w 73 p d 75 h 99

Armchair
Sessel
Fauteuil



Poltrona
l w 73 p d 75 h 94

Armchair
Sessel
Fauteuil





Linear può essere rivestita in tessuto o pelle, e nella particolare versione "mix" con tessuto e pelle insieme, che ne valorizza l'aspetto grazie ai dettagli della confezione.

Linear is available leather or fabric upholstered or in the special mixed version featuring fabric and leather together that enhances its beauty thanks to the detailed workmanship.

Linear kann mit Stoff oder Leder bezogen werden, bei der Version „Mix“ aus Leder und Stoff kommt hingegen dank der sorgfältigen Verarbeitung die Schönheit der Form besonders gut zur Geltung.

Le fauteuil Linear peut être revêtu soit en tissu soit en cuir et, dans la version « Mix », en tissu et en cuir qui en valorise l'aspect grâce à une confection soignée.





design *Daniela Lo Scalzo Moscheri*

Claire

The seat and backrest create a single, structural embrace. An elegant object designed for public and domestic spaces. The many upholsteries available give it a more traditional or modern appeal.

Sitzfläche und Rückenlehne bilden eine einzige strukturelle Umarmung. Ein elegantes, für öffentliche Räume und den privaten Wohnbereich entworfenes Sitzmöbel. Die zahlreichen lieferbaren Bezüge erlauben einen klassischen oder eher moderneren Ansatz.

L'assise et le dossier forment une unique structure enveloppante. Un objet élégant conçu pour des espaces publics et domestiques. Les nombreux revêtements au choix permettront de tendre vers un style soit plus classique soit moderne.

Seduta e schienale in un unico abbraccio strutturale. Un oggetto elegante concepito per spazi pubblici e domestici. I numerosi rivestimenti disponibili ne caratterizzeranno l'approccio più classico o moderno.

Poltrona
l w 76 p d 88 h 89

Armchair
Sessel
Fauteuil



Claire *Armchair*

122
Armchairs





design *Daniela Lo Scalzo Moscheri*



Claire

Swivel

Claire Swivel is inspired by the raised version of the same armchair from which it distinguishes itself because of its floor-standing swivel base that gives it its different appearance. Soft, bold lines blend in a comfortable, cross-functional product that is perfect in all sorts of settings.

Claire Swivel ist die etwas luftigere Version des Entwurfs. Der Sessel zeigt sich mit bodenstehendem Aufbau, der ihm einen neuen Look verleiht und genau zum drehbaren Grundgestell passt. Weiche und markante Linien vermischen sich zu einem bequemen und raumübergreifendem Sitzmöbel, das in jedem Raumentwurf eine gute Figur macht.

Claire Swivel s'inspire de la version plus "aérienne" de ce modèle, mais il se distingue et se différencie de celle-ci par une embase au sol pivotante qui donne au fauteuil un nouvel habillage. Des traits à la fois doux et forts se mélangent dans un produit confortable et transversal, capable de vivre dans différents styles d'intérieur.

Claire Swivel è ispirata alla versione più aerea; si caratterizza e differenzia per la base a terra che dona alla poltrona una nuova veste asservita al basamento girevole. Segni morbidi e decisi si mescolano in un prodotto confortevole e trasversale, capace di abitare diverse tipologie di ambienti.

Poltrona
l w 76 p d 88 h 93

Armchair
Sessel
Fauteuil



Claire Swivel *Armchair*







design Stefano Spessotto & Lorella Agnoletto

Jen

Jen stands out with its slender wooden base, its compact size and its informal familiar lines that recall vintage style: its timeless character makes it extremely versatile.

Jen zeichnet sich durch das schlanke Grundgestell aus Holz, die zurückhaltende Größe und die zwanglosen und vertrauenerweckenden Linien im dezenten Vintage-Look aus: Der Charakter ist zeitlos und macht das Modell extrem vielseitig.

Jen se distingue par un piètement élancé en bois, par de petites dimensions et par les lignes informelles et rassurantes qui rappellent le style vintage : son caractère est atemporel, voilà pourquoi il est extrêmement polyvalent.

Jen si distingue per la base in legno slanciata, per le dimensioni contenute e per le linee informali e rassicuranti che alludono al vintage: il carattere è senza tempo, per questo estremamente versatile.

Poltrona
l w 75 p d 75 h 72

Armchair
Sessel
Fauteuil





design Stefano Spessotto & Lorella Agnoletto

Ellie

The armchair recalls the classic design of the 1950s: harmonious and compact shapes are given a distinct and recognisable personality with pressure die-cast feet in exclusive design.

Ein Hinweis auf die Tradition des klassischen Designs der 50er Jahre: Harmonische und zurückhaltende Formen, die dank dem Fuß aus Aluguss mit exklusivem Entwurf einen entschiedenen und wiedererkennbaren Charakter erhalten.

Un rappel à la tradition du design classique des années 50 : des formes harmonieuses et une petite taille qui, grâce au pied moulé sous pression au design unique, acquièrent un caractère fort et distinguable.

Un rimando alla tradizione del classico design anni 50: forme armoniose e contenute, che grazie al piedino pressofuso dal disegno esclusivo, acquistano un carattere deciso e riconoscibile.

Poltrona
l w 80 p d 79 h 76

Armchair
Sessel
Fauteuil



Ellie Armchair

136
Armchairs





design Stefano Spessotto & Lorella Agnoletto

Ray

An armchair with all-embracing and comfortable lines, with elegant wood feet that add sophisticated appeal, for a perfect balance of vintage and modern design.

Ein Sessel mit einhüllenden und bequemen Linien, dem die eleganten Holzbeine eine raffinierte Note schenken und der die perfekte Balance zwischen Vintage und modernem Design hält.

Fauteuil aux lignes enveloppantes et confortables, soutenu par d'élégants pieds en bois qui lui donnent un air sophistiqué, en parfait équilibre entre le goût vintage et le design moderne.

Poltrona dalle linee avvolgenti e confortevoli, sostenuta da eleganti piedi in legno che le donano un'aria sofisticata, in perfetto equilibrio fra sapore vintage e design moderno.

Poltrona
l w 68 p d 79 h 95

Pouff
l w 59 p d 54 h 46

Armchair
Sessel
Fauteuil

Footstool
Hocker
Pouf





design Stefano Spessotto & Lorella Agnoletto

Dufflè

Timeless shapes that express ageless beauty are brought up to date, by innovative details in the lines, the frame and in the feet available in different finishing or in wooden eucalyptus and black nickel.

Unvergängliche Formen als Ausdruck einer zeitlosen Ästhetik, die sowohl bei den Linien des Aufbaus als auch beim Metallfuß in verschiedenen Ausführungen lieferbar, oder beim Holzfuß Eukalyptus und Metallfuß in schwarzer Nickelausführung durch ausgewogene innovative Details frischen Schwung erhält.

Des formes indémodables, expression d'une esthétique intemporelle, actualisées par une touche d'innovation équilibrée tant dans les lignes de la structure que dans le pied disponible en métal dans différentes finitions, or éventuellement en bois d'eucalyptus et en métal nickel noir.

Forme, intramontabili, espressione di un'estetica senza tempo, attualizzate da equilibrati tratti di innovazione sia nelle linee della scocca, sia nel piedino disponibile in metallo in varie finiture oppure in legno Eucalipto e metallo nichel nero.

Poltrona
l w 82 p d 90 h 114

Armchair
Sessel
Fauteuil



144
Armchairs



145
Armchairs



Piedino
Epoque

Feet
Füße
Pieds



Piedino
Kris

Feet
Füße
Pieds





design Stefano Spessotto & Lorella Agnoletto

Hug

Hug has great aesthetic appeal thanks to its special single-structure design for the seat and back, supported by exclusive wood armrests. This chair can play a key role in any interior.

Ein bühnenreifer Auftritt für Hug dank des ausgefallenen Entwurfs der Sitzfläche und Rückenlehne, die aus einem einzigen Element gebildet und von exklusiven Armlehnen aus Holz gestützt werden. Ein Objekt, das in jedem Raum eine Hauptrolle spielen kann.

Présence scénique pour le fauteuil Hug grâce au dessin particulier de l'assise et du dossier qui forme un élément unique soutenu par des accoudoirs exclusifs en bois. Un objet capable de jouer la vedette dans n'importe quel espace.

Presenza scenica per Hug, grazie al particolare disegno in un unico elemento di seduta e schienale, sostenuto dai braccioli esclusivi in legno. Un oggetto capace di giocare un ruolo di primo piano in qualsiasi ambiente.

Poltrona
l w 67 p d 88 h 87

Armchair
Sessel
Fauteuil



Hug *Armchair*

150
Armchairs





design Joe Colombo

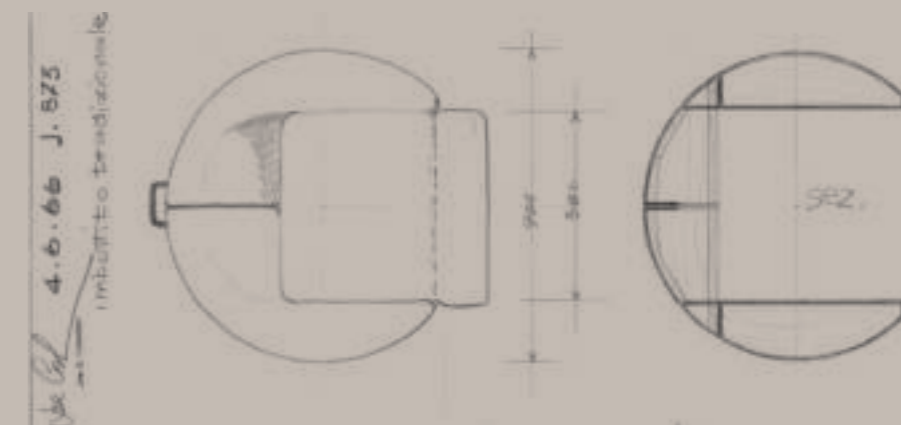

Cart

Exclusive collection

Designed in 1966 by Joe Colombo, the Cart armchair stands out for its remarkable formal dynamism. Ditre Italia has decided to produce it now, for the first time, transforming a project that has been left on paper for five decades into a product. A dream come true. A late tribute to the creativity of an Italian design icon. An original homage to his futuristic concept of furniture as a way by which man interacts with his habitat.

Der im Jahr 1966 von Joe Colombo entworfene Sessel Cart für den Innenbereich zeichnet sich durch einen starken formalen Dynamismus aus. Ditre Italia erzeugt ihn heute zum ersten Mal und verwandelt so ein für fünf Jahrzehnte auf dem Papier gebliebenes Projekt in ein reales Produkt. Eine Idee, die Wirklichkeit wird. Ein posthumer Tribut an die Kreativität einer italienischen Design-Ikone. Eine ungewöhnliche Anerkennung für seine zukunftsweisende Wahrnehmung der Einrichtung als Beziehungsform zwischen Mensch und Habitat.

Dessiné en 1966 par Joe Colombo, le fauteuil d'intérieur Cart se distingue par un dynamisme formel prononcé. Ditre Italia le réalise aujourd'hui pour la première fois, en transformant un projet, qui est resté pendant 50 ans sur le papier, en un produit. Une idée devenue réalité. Un hommage posthume à la créativité d'une icône du design italien. Un hommage inédit à sa conception avant-gardiste du mobilier comme forme de relation entre l'homme et l'habitat.

Disegnata nel 1966 da Joe Colombo, la poltroncina per interni Cart si distingue per lo spiccato dinamismo formale. Ditre Italia la realizza per la prima volta oggi, trasformando in prodotto un progetto rimasto cinque decenni sulla carta. Un'idea che si avvera. Un tributo postumo alla creatività di un'icona del design italiano. Un omaggio inedito alla sua avveniristica concezione dell'arredamento come forma di relazione fra uomo e habitat.

Poltrona
l w 97 p d 92 h 73

Armchair
Sessel
Fauteuil



Cart accorpa i braccioli e lo schienale in un'unica struttura avvolgente, ergonomica, studiata per dare alle braccia un comodo appoggio ad altezza naturale. La parte anteriore è sostenuta da due rotelle frontali monodirezionali, quella posteriore da due piedini. La seduta, formata da un cuscino leggermente sporgente, delicatamente curvato sul davanti, favorisce una postura delle gambe rilassata.

The back and armrests are, in Cart, a single, ergonomic, wraparound structure designed to give the arms a comfortable support at a natural height. The front is supported by two, unidirectional wheels, the rear by two feet. The seat consists in a slightly protruding cushion that is gently curved at the front and promotes a relaxed position of the legs.

Cart vereint die Armlehnen und die Rückenlehne in einem einzigen einhüllenden und ergonomischen Aufbau, der den Armen eine bequeme Ablagefläche in natürlicher Höhe bietet. Der Vorderteil wird von zwei Möbelrollen getragen, der rückwärtige Teil steht auf zwei Füßen. Die Sitzfläche besteht aus einem leicht vorstehenden und vorne sanft abgerundeten Kissen, das eine entspannte Beinhaltung fördert.

Cart unit les accoudoirs et le dossier pour créer une unique structure enveloppante et ergonomique, étudiée pour donner un confortable appui aux bras à une hauteur naturelle. Le fauteuil est supporté à l'avant par deux roulettes monodirectionnelles et à l'arrière par deux pieds. L'assise, formée d'un coussin légèrement débordant et délicatement courbe à l'avant, favorise une position relaxante pour les jambes.





design Studio Joe Colombo

Class

The Class armchair is the outcome of accurate, concise research that always originates from a function and from the study of ergonomics. Its clean-cut, rounded and simple lines are paired with a seat that is comfortable enough for homes and for the hospitality sector alike. Its cross-functional nature is confirmed by the swivel movement of its base.

Der Sessel Class ist das Ergebnis eines präzisen und synthetischen Ablaufs, der immer mit einer Funktion und dem Studium der Ergonomie beginnt. Das klare, abgerundete und schnörkellose Design wird von einem Sitzkomfort begleitet, der das Modell für den Wohnbereich, aber auch für die Contractbranche geeignet macht. Das Grundgestell des Sessels ist mit einem Drehmechanismus ausgestattet, der seine raumübergreifende Natur bestätigt.

Le fauteuil Class est le résultat d'un parcours précis et concis dont le point de départ est toujours une fonction et une étude de l'ergonomie. La forme marquée, ronde et simple, s'associe à un confort d'assise adapté tant aux habitations qu'aux collectivités. L'embase du fauteuil est dotée d'un mouvement pivotant qui confirme sa nature transversale.

La poltrona Class è il risultato di un percorso preciso e sintetico che parte sempre da una funzione e dallo studio della ergonomia. Il tratto deciso, rotondo, semplice si associa ad un confort di seduta adatto alle abitazioni ma anche in ambito contract. Il basamento della poltrona è dotato di movimento girevole, che conferma la sua natura trasversale.

Poltrona
l w 86 p d 93 h 80



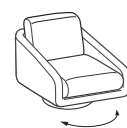







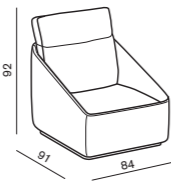
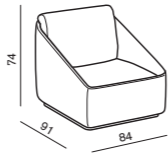



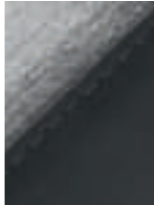
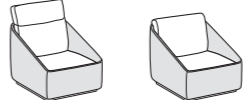

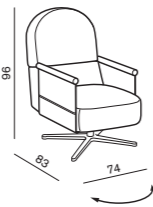
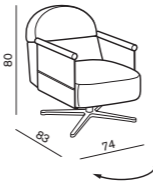



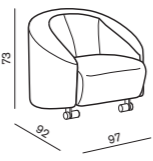



Armchair
Sessel
Fauteuil

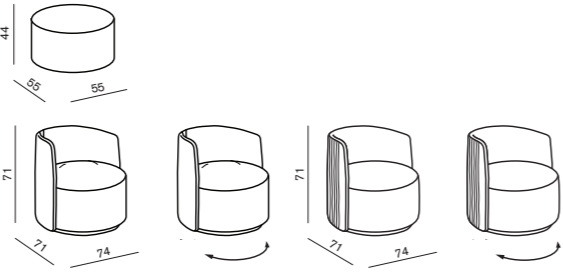





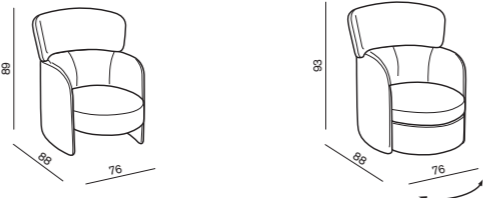







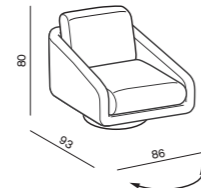



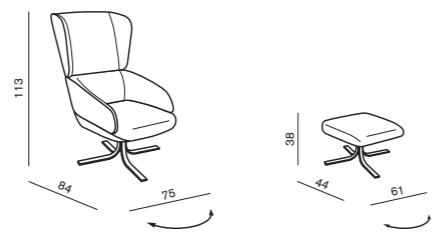





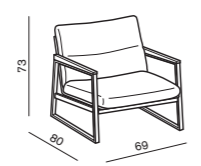

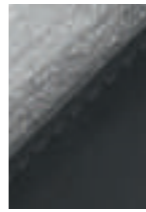

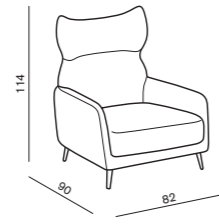



Schede tecniche

data sheets

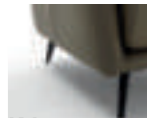
		dimensioni / dimensions		finiture / finishes			finiture piedini, basamento e struttura con braccioli / finishes of feet, base and frame with armrests		
Bend		High	Low	Tessuto	Similpelle	Bicolore tessuto/tessuto tessuto/similpelle	Pelle	Mix pelle/ tessuto	ABS nero
									
Beyl		High	Low	Tessuto	Similpelle		Pelle		Swivel metallo nero ME09
									
Cart				Tessuto	Similpelle	Bicolore tessuto/tessuto tessuto/similpelle			ABS grigio ruote Piedini legno LE09 nero
									
Chloè	Chloè luxury			Tessuto	Similpelle	Bicolore tessuto/tessuto tessuto/similpelle	Pelle	Note / Notes: Nella versione Chloè luxury non sono disponibili i rivestimenti in simil-pelle e pelle <i>Eco-leather and leather are not available for the Chloè luxury version.</i>	ABS nero Swivel metallo nero ME09
									
Claire	Claire swivel				Similpelle		Pelle		Legno nero LE09 Swivel metallo nero ME09
									

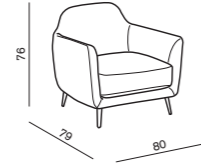









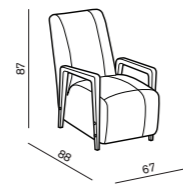



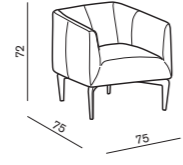



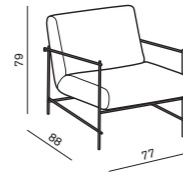







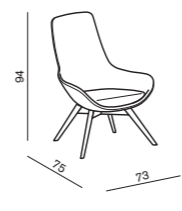



Schede tecniche

data sheets

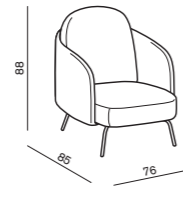
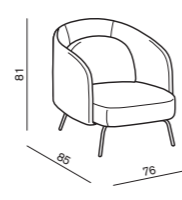
	dimensioni / dimensions	finiture / finishes					
Class	 	Tessuto	Bicolore tessuto/tessuto	Pelle		finiture piedini, basamento e struttura con braccioli / finishes of feet, base and frame with armrests	
						Swivel metallo nero ME09	
Cut	 	Tessuto		Pelle	Mix pelle/ tessuto	Swivel metallo antracite ME01 Swivel metallo light brown ME11	
					 		
Daytona	 			Pelle	Mix pelle/ tessuto	Nero ME09 + eucalipto LE05 Nero ME09 + gray wood LE12 Cromo nero ME05 + eucalipto LE05 Cromo nero ME05 + gray wood LE12	
					 		
Dufflé	 	Tessuto	Similpelle	Bicolore tessuto/tessuto tessuto/similpelle	Pelle	Mix pelle/ tessuto	Cromo nero ME05 + eucalipto LE05 Antracite ME01 Gesso ME02 Testa di moro ME03 Cromo lucido ME04 Cromo nero ME05
						 	 Epoque  Kris
Ellie	 	Tessuto	Similpelle		Pelle		Antracite ME01 Gesso ME02 Testa di moro ME03 Cromo lucido ME04 Cromo nero ME05
							

Schede tecniche

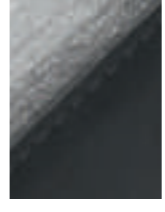
data sheets

	dimensioni <i>/ dimensions</i>		finiture <i>/ finishes</i>						
Hug			Tessuto 	Similpelle 	Pelle 	finiture piedini, basamento e struttura con braccioli <i>/ finishes of feet, base and frame with armrests</i> Eucalipto LE05			
Jen			Tessuto 	Similpelle 	Pelle 	Gray wood LE12 Eucalipto LE05			
Kyo			Tessuto 	Similpelle 	Pelle 	Mix pelle/ tessuto 	Nero ME09 Gold ME10 Light brown ME11 		
Linear				Tessuto 	Similpelle 	Bicolore tessuto/tessuto tessuto/similpelle 	Pelle 	Mix pelle/ tessuto 	Swivel antracite ME01 Swivel testa di moro ME03 Legno eucalipto LE05 Legno gray wood LE12  
Lucia		High 	Low 	Tessuto 	Bicolore tessuto/tessuto 	Pelle 	Mix pelle/ tessuto 	Nero ME09 Cromo nero ME05 Light brown ME11  	

Schede tecniche

data sheets

	dimensioni / dimensions	finiture / finishes		finiture piedini, basamento e struttura con braccioli / finishes of feet, base and frame with armrests			
Nathy		Tessuto	Pelle	Eucalipto LE05 Gray wood LE12			
Ray		Tessuto	Similpelle	Bicolore tessuto/tessuto tessuto/similpelle	Pelle	Gray wood LE12 Eucalipto LE05	
Round		Tessuto	Similpelle	Bicolore tessuto/tessuto tessuto/similpelle	Pelle	Mix pelle/ tessuto	Legno eucalipto LE05 Legno gray wood LE12 Swivel antracite ME01 Swivel testa di moro ME03 Iron nero ME09 Iron cromo nero ME05
Softy		Tessuto	Bicolore tessuto/tessuto tessuto/similpelle	Mix pelle/ tessuto	Legno eucalipto LE05 Legno gray wood LE12 Swivel antracite ME01 Swivel testa di moro ME03 Iron nero ME09 Iron cromo nero ME05		
St. Tropez		Tessuto	Similpelle	Bicolore tessuto/tessuto tessuto/similpelle	Pelle	Mix pelle/ tessuto	Eucalipto LE05 Gray wood LE12

Designer

Joe Colombo / Studio Joe Colombo:
Cart / Class

Stefano Spessotto & Lorella Agnoletto:
Chloè / Dufflé / Ellie / Jen / Kyo / Hug / Ray

Daniele Lo Scalzo Moscheri:
Bend / Claire / Cut / Daytona / St. Tropez

Edi & Paolo Ciani Design:
Linear / Round / Softy

Gabriele e Oscar Buratti:
Beyl / Nathy

Federica Biasi:
Lucia

Concept and Graphic Design

ID_Alzo Ltd

Photo

Matteo Imbriani
Claudio Rocci
Photografica

Styling

Patrizia Toffolo

Fotolito

Luce Group

Stampa

Grafiche Antiga spa

Gennaio 2019

DITRE
ITALIA

**DITRE
ITALIA**

31016 Cordignano (Treviso) Zona Industriale Via del Lavoro, 21
Tel. +39.0438.9999 Fax +39.0438.999993 www.ditreitalia.it info@ditreitalia.it