D
ANDY
HOME

The logo consists of the word 'D' in a large, white, serif font. Below it, the word 'ANDY' is written in a similar white serif font. Underneath 'ANDY', the word 'HOME' is written in a smaller, red, sans-serif font. A small, stylized Italian flag (green, white, and red horizontal stripes) is positioned between the 'N' and 'D' of 'ANDY', appearing as a horizontal bar within the letter 'Y'.

WELCOME IN

DANDY

HOME

The concept of "Dandy Home Collection" aims at living a unique fashion - oriented lifestyle. The exclusive character of the products is inspired by the world of fashion through new combinations of materials and details.

A great collection of Leather upholstered products and furniture accessories, created and managed by designer Giuseppe Viganò.

Dandy Home Collection is entirely manufactured in Italy and distributed by Gamma Arredamenti International S.p.A. all over the world.



Designer Giuseppe Viganò



WOLF 4



TUXEDO 10



EDWIN 16



HOLLYWOOD 24



MARLON 30



MARILYN 38



McQUEEN 44



CROSSOVER 50



KONG 56



CADILLAC 64



LIMOUSINE 74



JACK 84



BRANDY 92



VESSEL 98



WAFER 112



BORDER 120



OXER 126



DEAN 5



LOLITA 7



LOBSTER 8



HARLEY 11



GLOSS 15



EDWIN 19



GEM 42



CROSSOVER 55



CHARLOTTE 82



TRENCH 86



SNOB 116



STRIPES 5



COFFEE TABLES 6



COFFEE TABLES 18



COFFEE TABLES 24



CLEPSYDRA 26



KONG COFFEE TABLES 61



IBIS 81



BOULEVARD 96



SMART STOOLS 44



ROYAL PILLOWS 104



BAGS 108



BIG BAG 90

DANDY HOME



WOLF
DEAN
STRIPES
LOLA BAG
ROYAL PILLOWS





8
WOLF
LOBSTER
STRIPES
ROYAL PILLOWS



9
WOLF

























A Ω
CULTURA
EDUCAZIONE
FAIR PLAY
BON TON
ORA



































































































MARLON NIGHT 132



KONG NIGHT 136



MARILYN NIGHT 140



McQUEEN NIGHT 142



CROSSOVER NIGHT 146



JACK NIGHT 150



WAFER NIGHT 154



JAZZ NIGHT 158



SUITE NIGHT 162



OXER NIGHT 168



BAG NIGHT 172



ZIPPER NIGHT 176



DEAN 132



LOLITA 135



GEM 141



CROSSOVER 142



TRENCH 151



LOBSTER 155



FRINGE 159



SUITE NIGHT CH 167



NIGHT STANDS 132



KONG COFFEE TABLES 137



COFFEE TABLES 140



CLEPSYDRA 150



NIGHT STANDS 154



COFFEE TABLES 169



COFFEE TABLES 176



ROYAL PILLOWS 133



BAGS 146



JACK MIRROR 153



MIRRORS 162



BIG BAG 168

















































BORDER Design Giuseppe Viganò

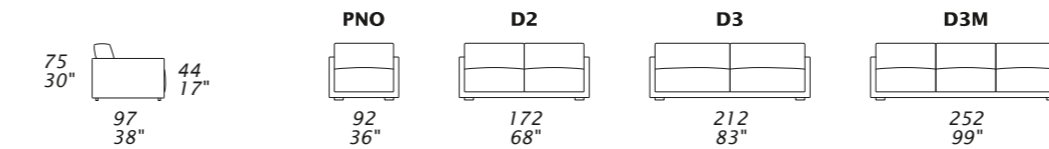

X all items in group X have the same seat width – tutti gli elementi del gruppo X hanno lo stesso modulo di seduta

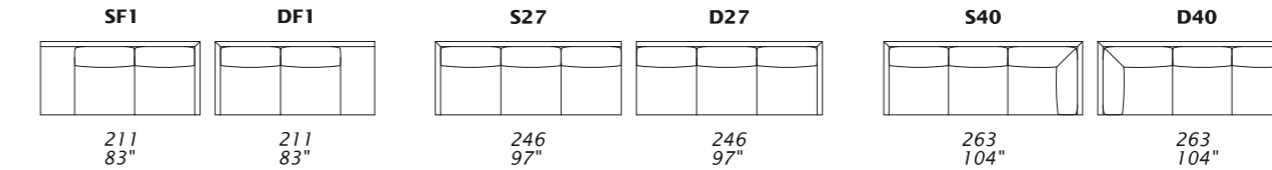
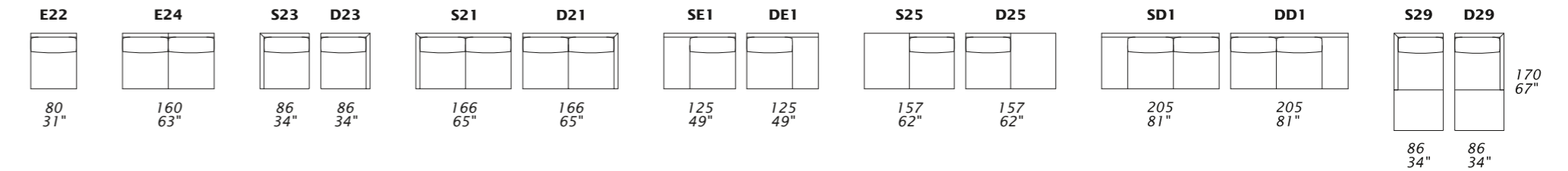

J all items in group J have the same seat width – tutti gli elementi del gruppo J hanno lo stesso modulo di seduta

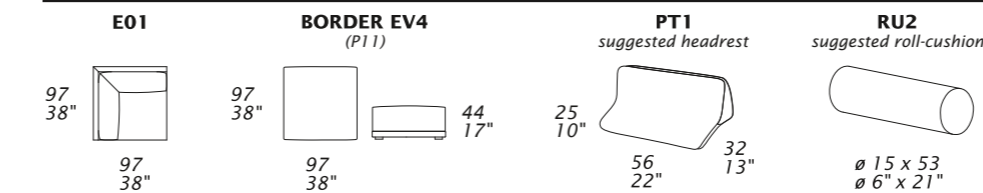
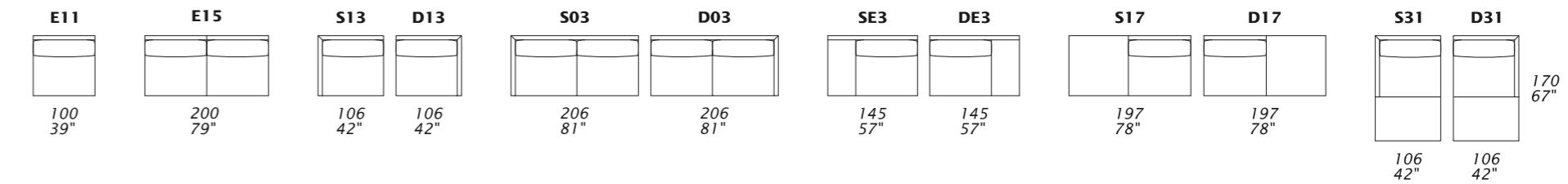

Dimensions: the first figure shows sizes in centimeters, the second in inches.
 Each piece is made by hand and has its own uniqueness. Measures may vary with a tolerance up to 3%.
 Mixing above groups (X - J) will create sectionals with different seat widths.
 Corner piece E01 is an odd piece and can be used with all above groups X - J.
 Seat depth 63 cm - 25".



BRANDY

Design Giuseppe Viganò

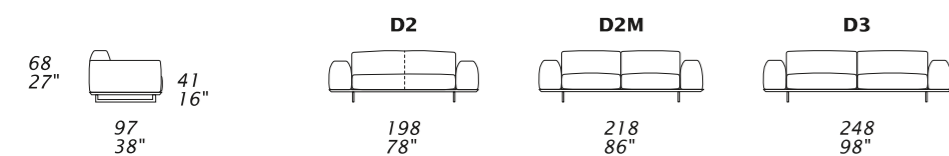

Y

all items in group Y have the same seat width – tutti gli elementi del gruppo Y hanno lo stesso modulo di seduta

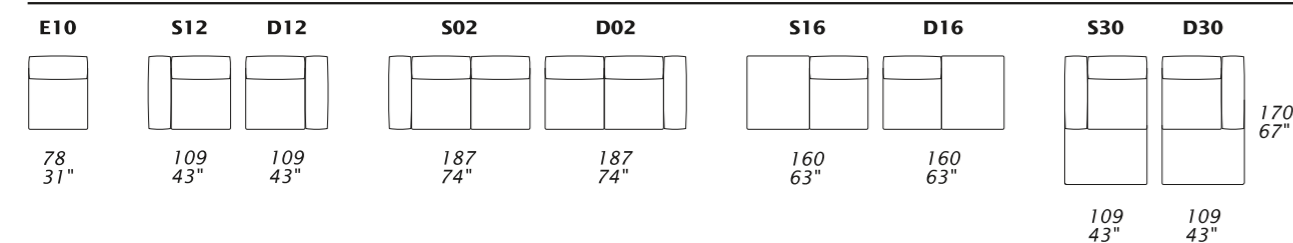

J

all items in group J have the same seat width – tutti gli elementi del gruppo J hanno lo stesso modulo di seduta

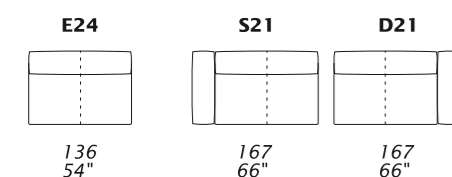
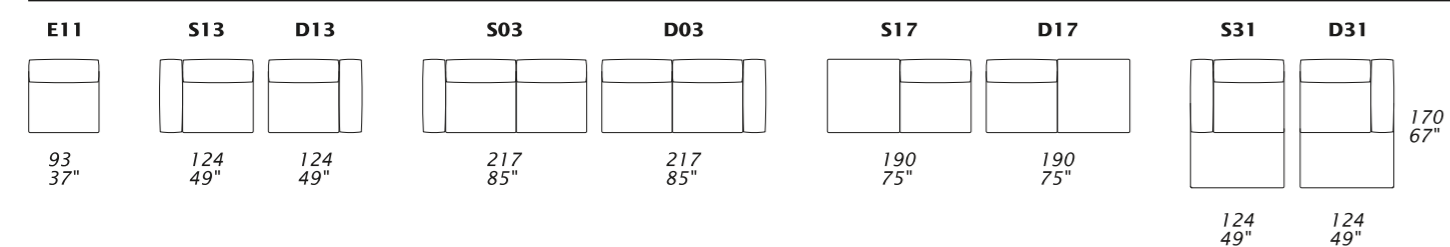

●———— *elementi con cuscino intero* —————●
 ●———— *elements with bench cushion* —————●

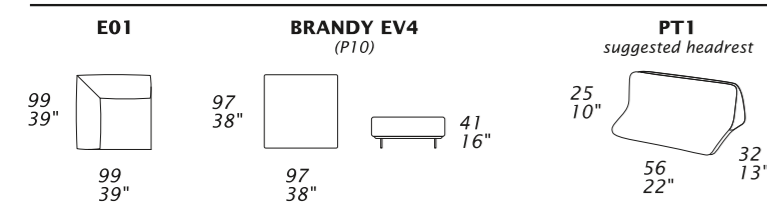

Dimensions: the first figure shows sizes in centimeters, the second in inches.
 Each piece is made by hand and has its own uniqueness. Measures may vary with a tolerance up to 3%.

Mixing above groups (Y - J) will create sectionals with different seat widths.

Corner piece E01 is an odd piece and can be used with all above groups Y - J.

Seat depth 62 cm - 24".

Technical sheet

CADILLAC

Design Giuseppe Viganò

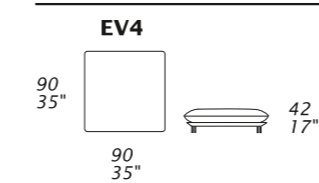
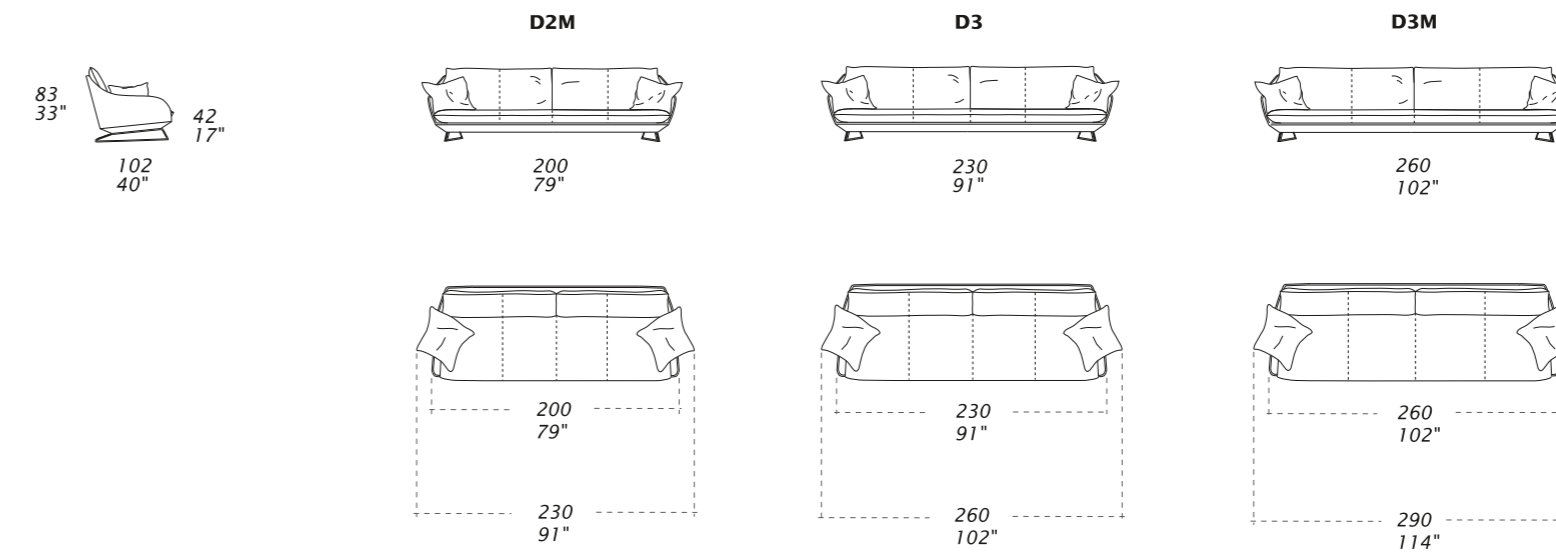

Dimensions: the first figure shows sizes in centimeters, the second in inches.
 Each piece is made by hand and has its own uniqueness. Measures may vary with a tolerance up to 3%.

Seat depth 60 cm - 24".

Technical sheet

CROSSOVER

Design Giuseppe Viganò

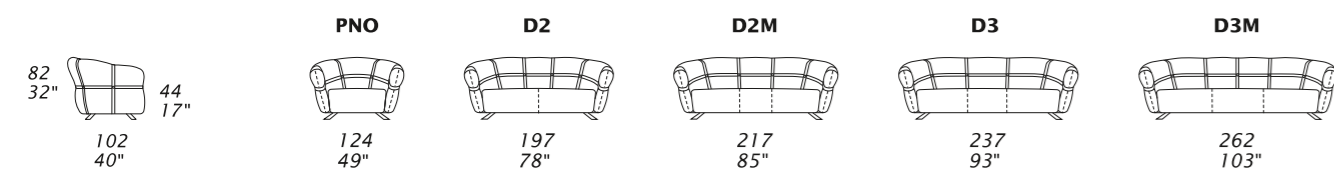

X all items in group X have the same seat width – tutti gli elementi del gruppo X hanno lo stesso modulo di seduta

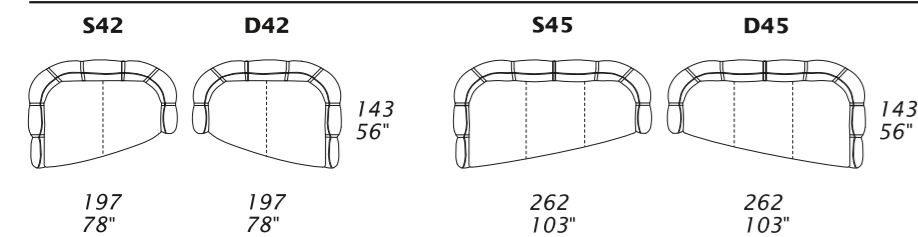

Y all items in group Y have the same seat width – tutti gli elementi del gruppo Y hanno lo stesso modulo di seduta

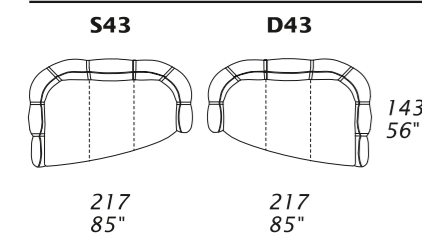

J all items in group J have the same seat width – tutti gli elementi del gruppo J hanno lo stesso modulo di seduta

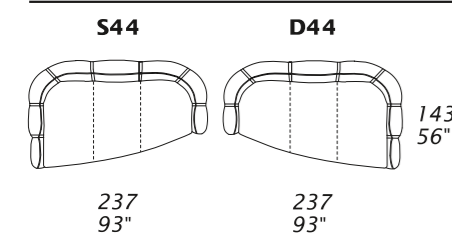

Dimensions: the first figure shows sizes in centimeters, the second in inches.
Each piece is made by hand and has its own uniqueness. Measures may vary with a tolerance up to 3%.
Seat depth 64 cm - 25".

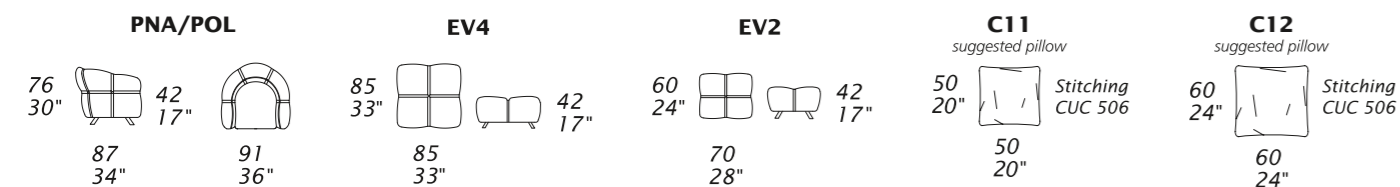

Technical sheet

EDWIN

Design Giuseppe Viganò

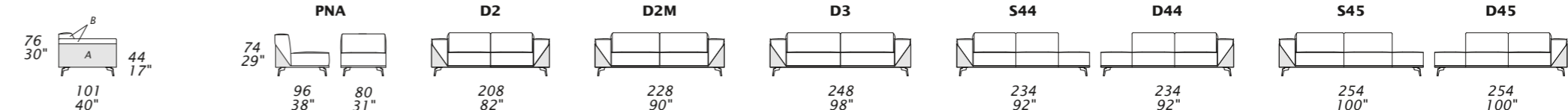

X all items in group X have the same seat width – tutti gli elementi del gruppo X hanno lo stesso modulo di seduta

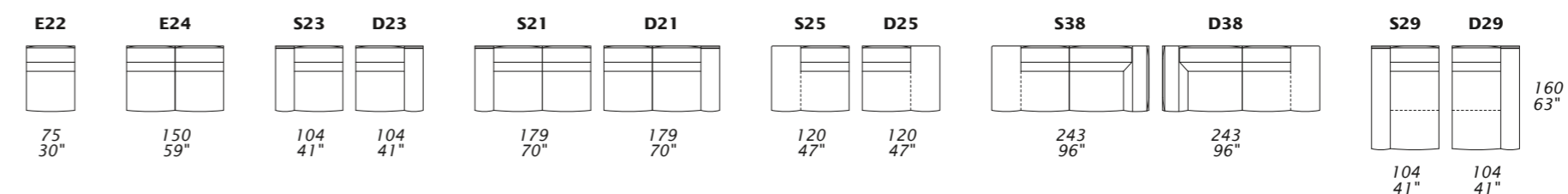

Y all items in group Y have the same seat width – tutti gli elementi del gruppo Y hanno lo stesso modulo di seduta

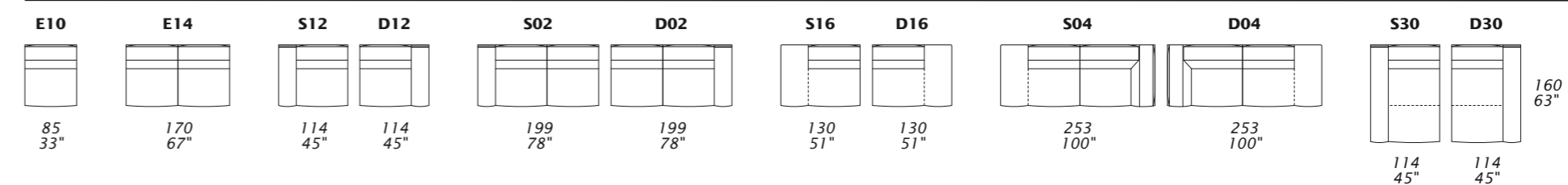

J all items in group J have the same seat width – tutti gli elementi del gruppo J hanno lo stesso modulo di seduta

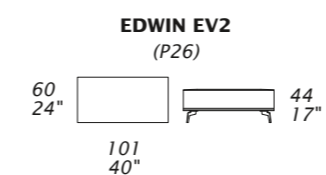
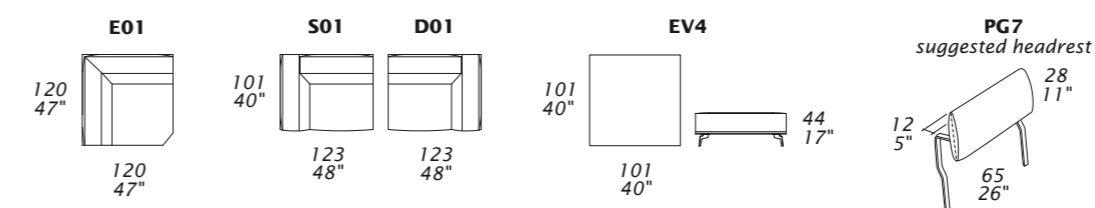
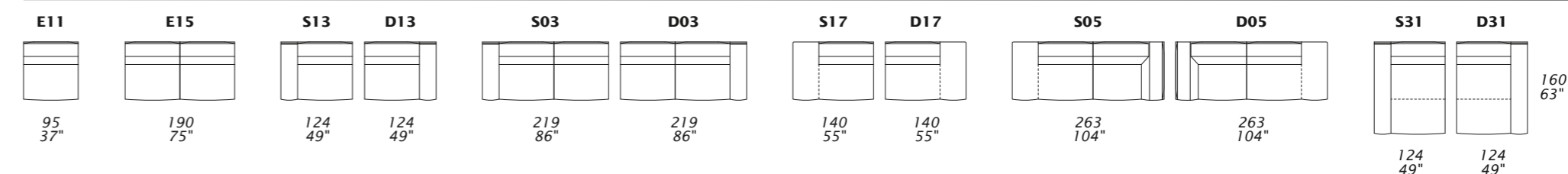

Dimensions: the first figure shows sizes in centimeters, the second in inches.
Each piece is made by hand and has its own uniqueness. Measures may vary with a tolerance up to 3%.
Mixing above groups (X - Y - J) will create sectionals with different seat widths.
Corner pieces E01, S01 and D01 are odd pieces and can be used with all above groups X - Y - J.
Seat depth 62 cm - 24".

Technical sheet

HOLLYWOOD

Design Giuseppe Viganò

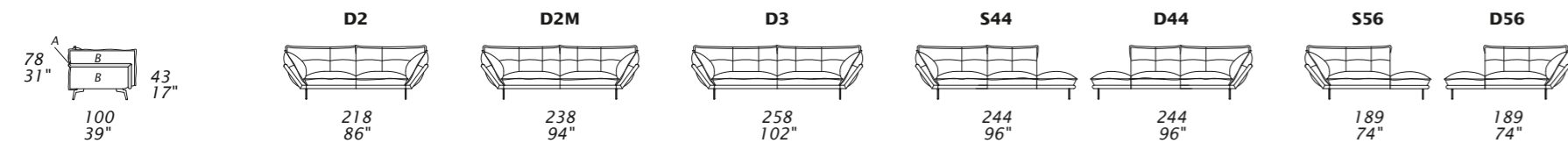

X all items in group X have the same seat width – tutti gli elementi del gruppo X hanno lo stesso modulo di seduta

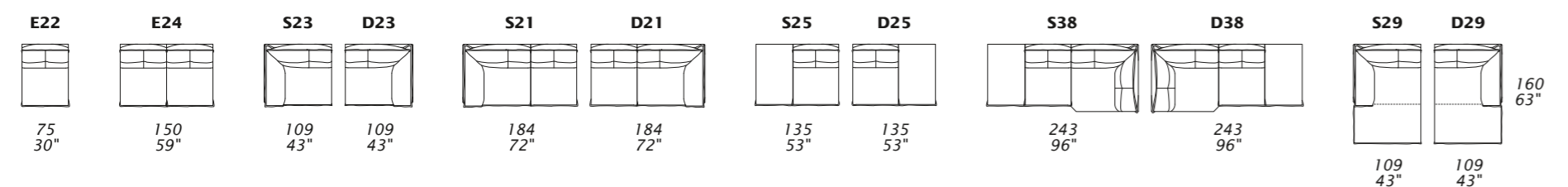

Y all items in group Y have the same seat width – tutti gli elementi del gruppo Y hanno lo stesso modulo di seduta

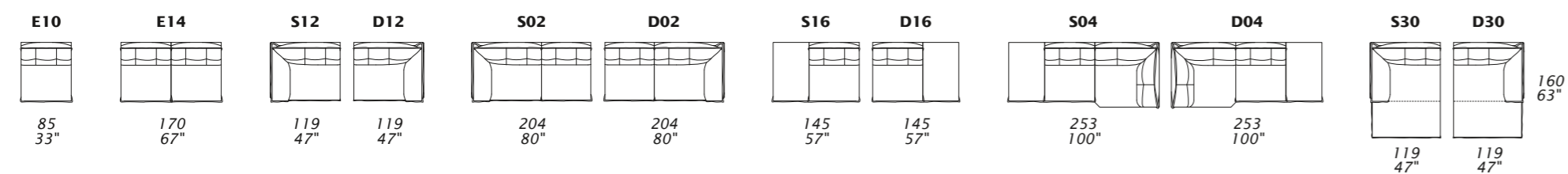

J all items in group J have the same seat width – tutti gli elementi del gruppo J hanno lo stesso modulo di seduta

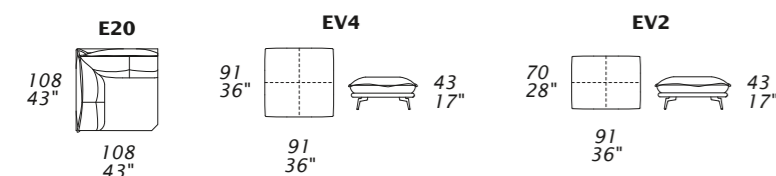
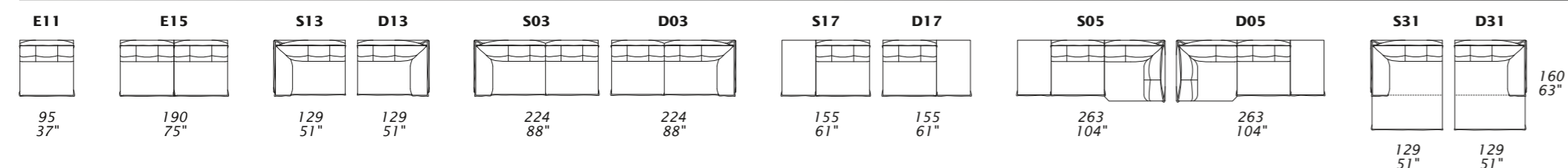

Dimensions: the first figure shows sizes in centimeters, the second in inches.

The soft rim (2,5 cm/1 inch) is not included in measures.

Each piece is made by hand and has its own uniqueness. Measures may vary with a tolerance up to 3%.

Mixing above groups (X - Y - J) will create sectionals with different seat widths.

Corner piece E20 is an odd piece and can be used with all above groups X - Y - J.

Seat depth 60 cm - 24".

Technical sheet

JACK

Design Giuseppe Viganò

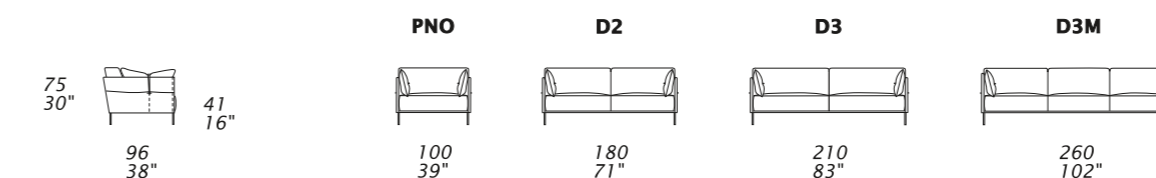

X all items in group X have the same seat width – tutti gli elementi del gruppo X hanno lo stesso modulo di seduta

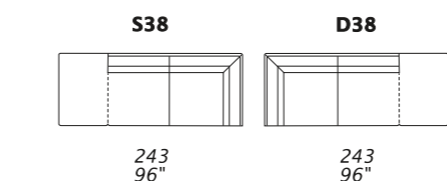
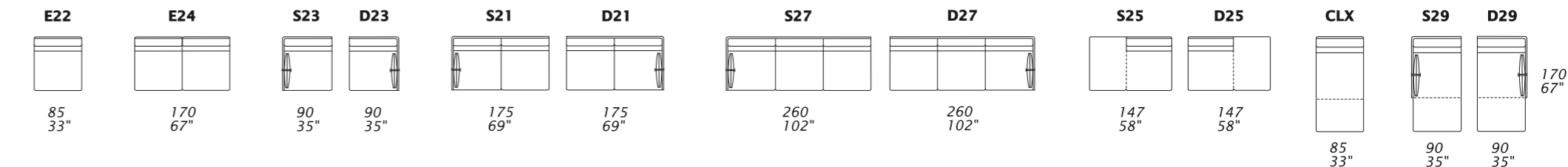

J all items in group J have the same seat width – tutti gli elementi del gruppo J hanno lo stesso modulo di seduta

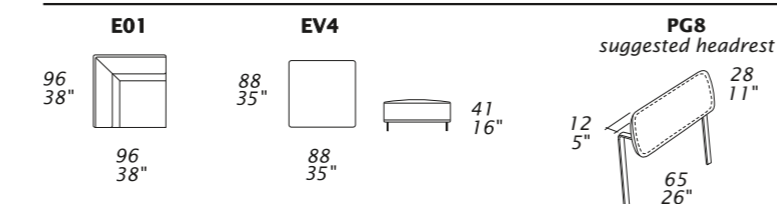
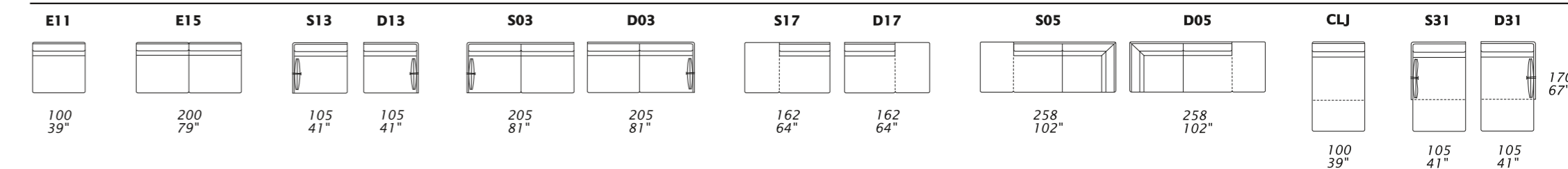

Dimensions: the first figure shows sizes in centimeters, the second in inches.

Each piece is made by hand and has its own uniqueness. Measures may vary with a tolerance up to 3%.

Mixing above groups (X - J) will create sectionals with different seat widths.

Corner piece E01 is an odd piece and can be used with all above groups X - J.

Seat depth 62 cm - 24".

Technical sheet

KONG

Design Giuseppe Viganò

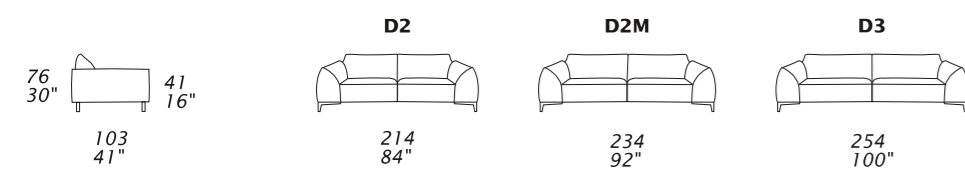

X all items in group X have the same seat width – tutti gli elementi del gruppo X hanno lo stesso modulo di seduta

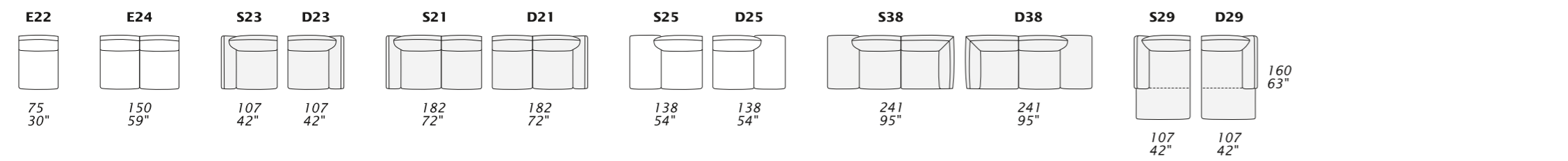

Y all items in group Y have the same seat width – tutti gli elementi del gruppo Y hanno lo stesso modulo di seduta

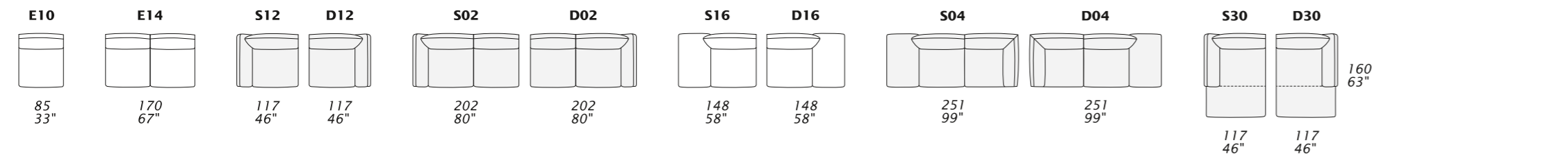

J all items in group J have the same seat width – tutti gli elementi del gruppo J hanno lo stesso modulo di seduta

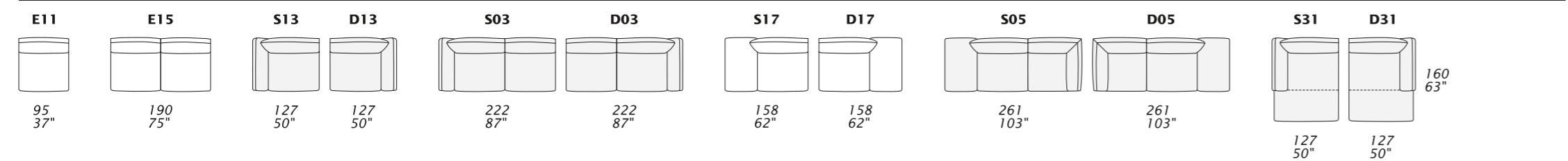

S56 259 102"

D56 259 102"

Standard back

Back cushions with wings

When the following sectional elements are ordered together with S56/D56, the back cushion will be produced with a wing on the side, as shown in the pricelist picture.

S/D23 - S/D21 - S/D38 - S/D29 - S/D12 - S/D02 - S/D04
 S/D30 - S/D13 - S/D03 - S/D05 - S/D31

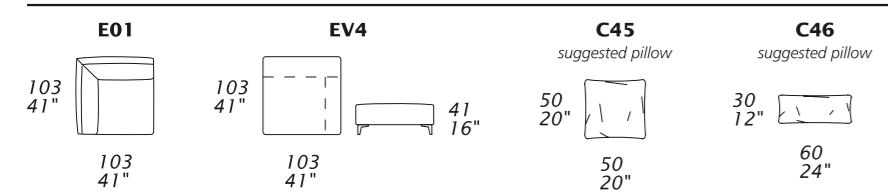

Dimensions: the first figure shows sizes in centimeters, the second in inches.
 Each piece is made by hand and has its own uniqueness. Measures may vary with a tolerance up to 3%.
 Mixing above groups (X - Y - J) will create sectionals with different seat widths.
 Corner piece E01 is an odd piece and can be used with all above groups X - Y - J.
 Seat depth 64 cm - 25".

LIMOUSINE

Design Giuseppe Viganò

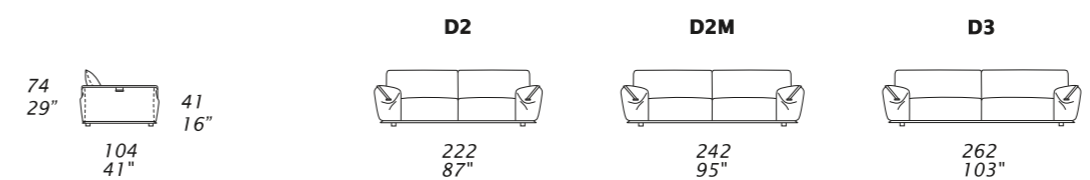

X all items in group X have the same seat width – tutti gli elementi del gruppo X hanno lo stesso modulo di seduta

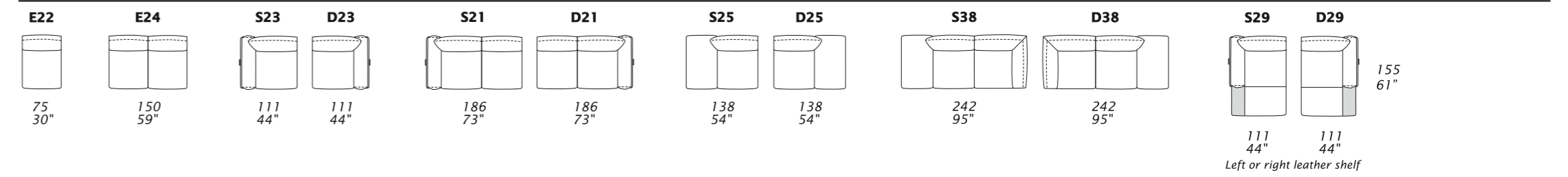

Y all items in group Y have the same seat width – tutti gli elementi del gruppo Y hanno lo stesso modulo di seduta

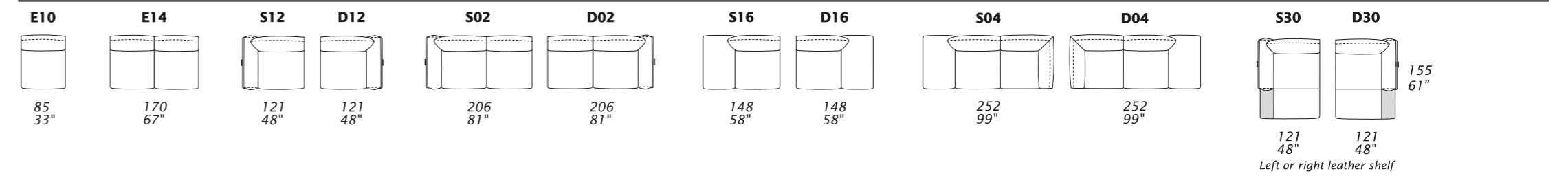

J all items in group J have the same seat width – tutti gli elementi del gruppo J hanno lo stesso modulo di seduta

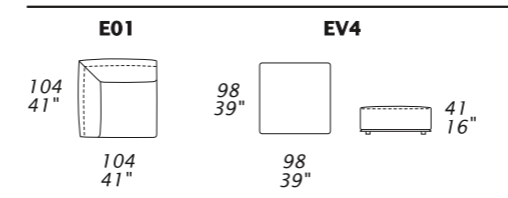
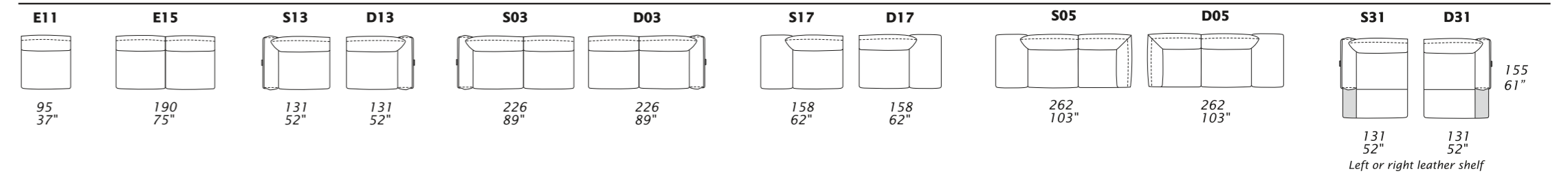

Dimensions: the first figure shows sizes in centimeters, the second in inches.
 Each piece is made by hand and has its own uniqueness. Measures may vary with a tolerance up to 3%.
 Mixing above groups (X - Y - J) will create sectionals with different seat widths.
 Corner piece E01 is an odd piece and can be used with all above groups X - Y - J.
 Seat depth 64 cm - 25".

MARILYN

Design Giuseppe Viganò

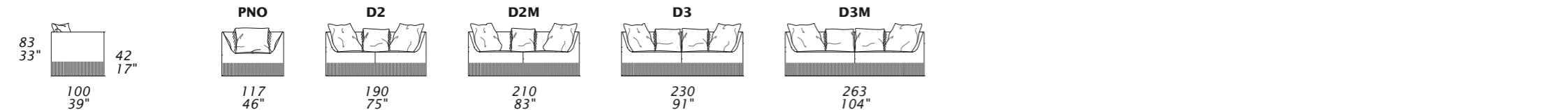

X all items in group X have the same seat width – tutti gli elementi del gruppo X hanno lo stesso modulo di seduta

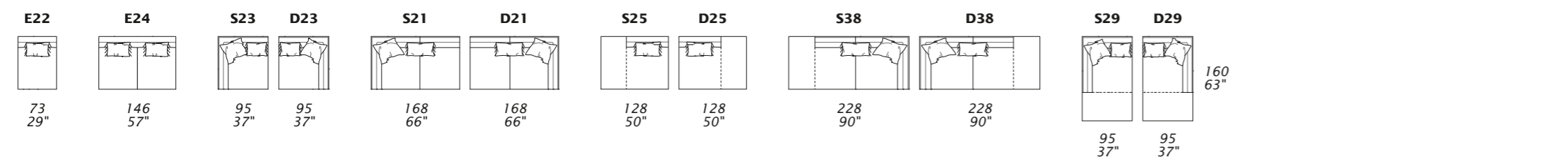

Y all items in group Y have the same seat width – tutti gli elementi del gruppo Y hanno lo stesso modulo di seduta

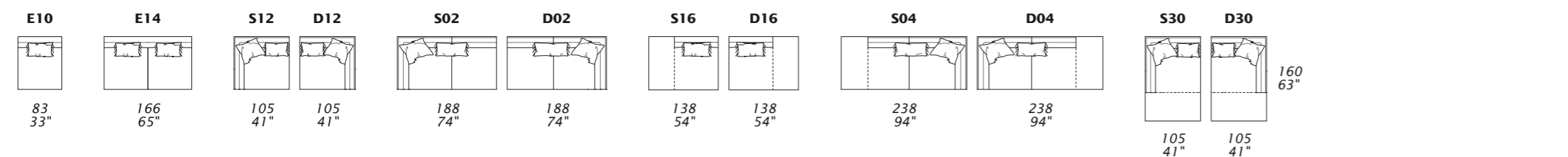

J all items in group J have the same seat width – tutti gli elementi del gruppo J hanno lo stesso modulo di seduta

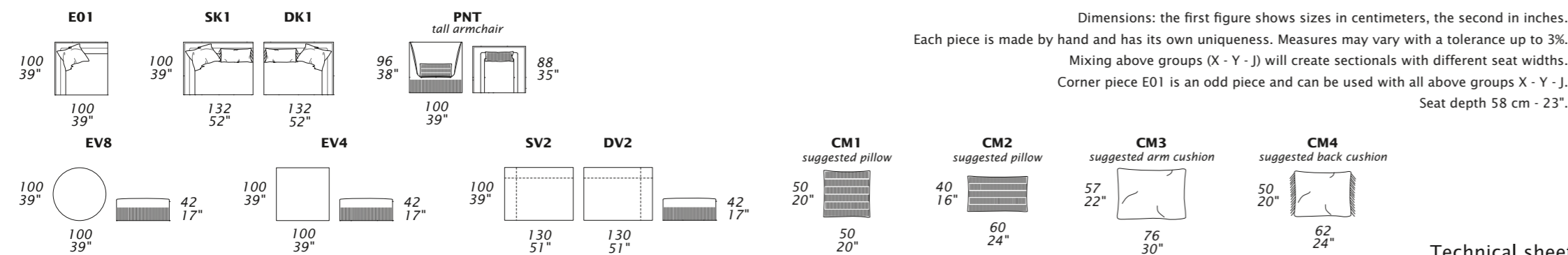
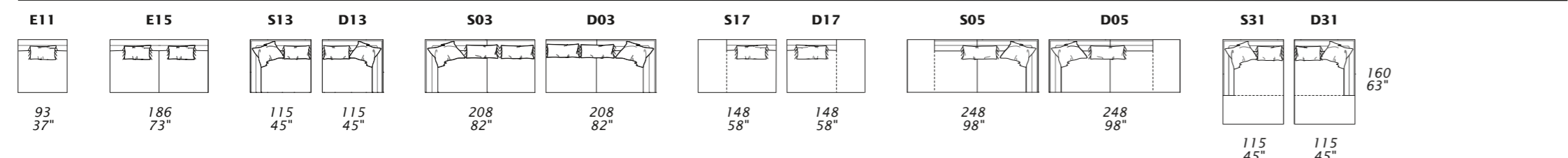

Dimensions: the first figure shows sizes in centimeters, the second in inches.
 Each piece is made by hand and has its own uniqueness. Measures may vary with a tolerance up to 3%.
 Mixing above groups (X - Y - J) will create sectionals with different seat widths.
 Corner piece E01 is an odd piece and can be used with all above groups X - Y - J.
 Seat depth 58 cm - 23".

MARLON

Design Giuseppe Viganò

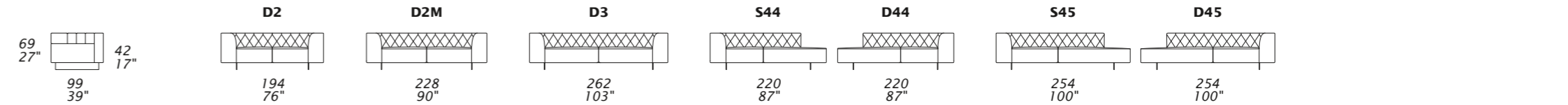

X all items in group X have the same seat width – tutti gli elementi del gruppo X hanno lo stesso modulo di seduta

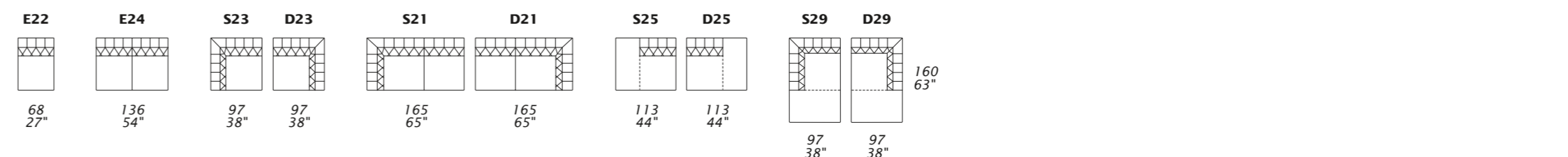

Y all items in group Y have the same seat width – tutti gli elementi del gruppo Y hanno lo stesso modulo di seduta

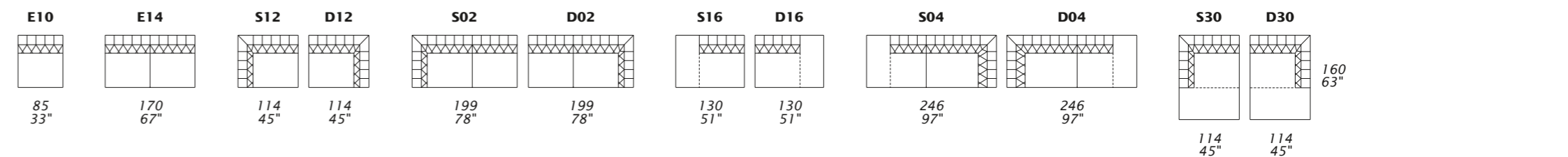

J all items in group J have the same seat width – tutti gli elementi del gruppo J hanno lo stesso modulo di seduta

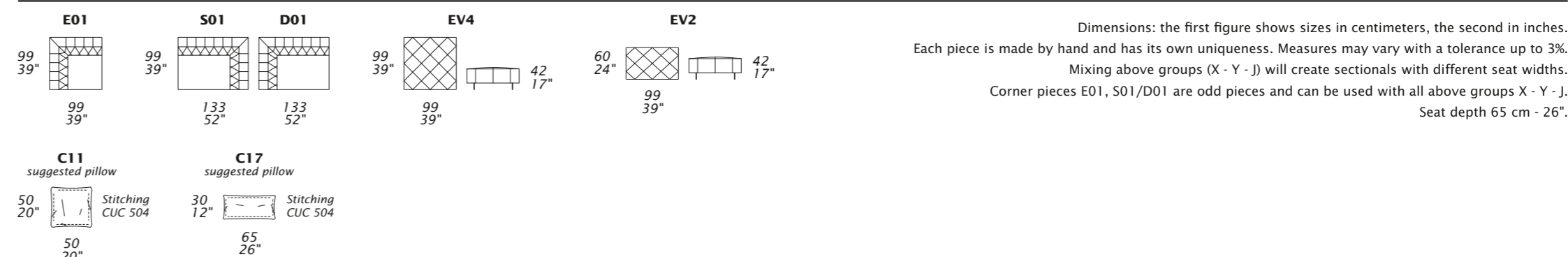
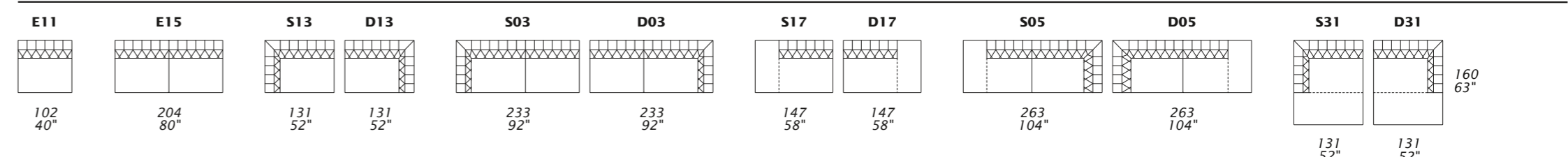

Dimensions: the first figure shows sizes in centimeters, the second in inches.
 Each piece is made by hand and has its own uniqueness. Measures may vary with a tolerance up to 3%.
 Mixing above groups (X - Y - J) will create sectionals with different seat widths.
 Corner pieces E01, S01/D01 are odd pieces and can be used with all above groups X - Y - J.
 Seat depth 65 cm - 26".

McQUEEN

Design Giuseppe Viganò

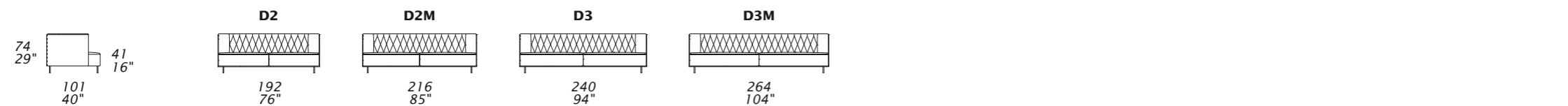

X all items in group X have the same seat width – tutti gli elementi del gruppo X hanno lo stesso modulo di seduta

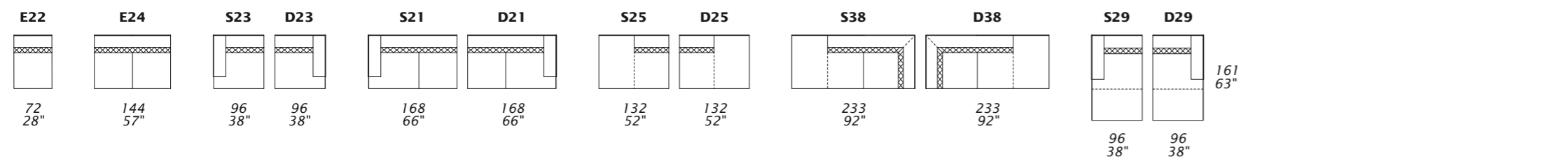

Y all items in group Y have the same seat width – tutti gli elementi del gruppo Y hanno lo stesso modulo di seduta

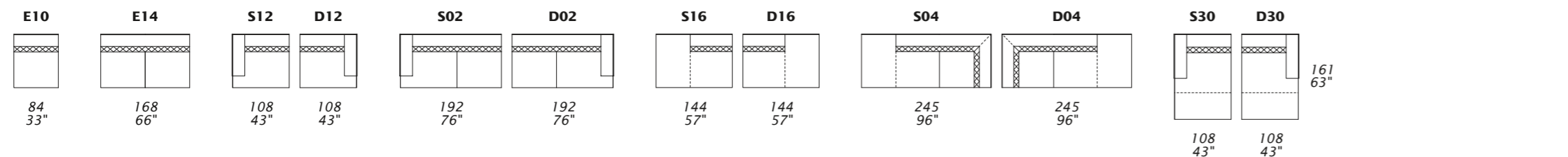

J all items in group J have the same seat width – tutti gli elementi del gruppo J hanno lo stesso modulo di seduta

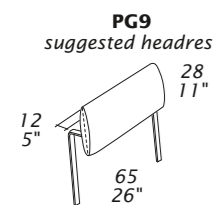
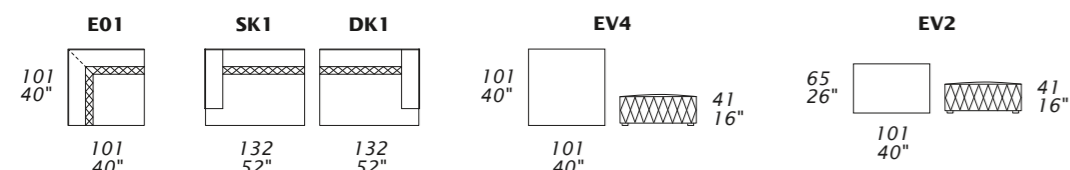
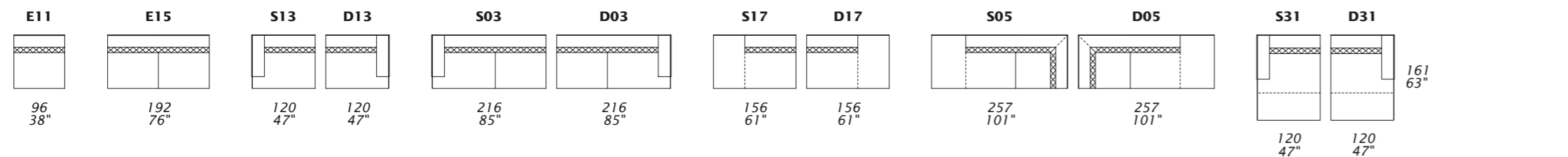

Dimensions: the first figure shows sizes in centimeters, the second in inches.
Each piece is made by hand and has its own uniqueness. Measures may vary with a tolerance up to 3%.
Mixing above groups (X - Y - J) will create sectionals with different seat widths.
Corner piece E01 is an odd piece and can be used with all above groups X - Y - J.
Seat depth 63 cm - 25".

OXER

Design Giuseppe Viganò

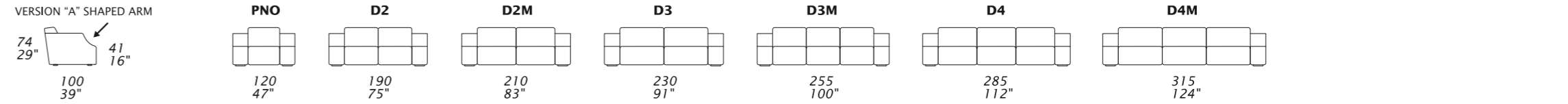

X all items in group X have the same seat width – tutti gli elementi del gruppo X hanno lo stesso modulo di seduta

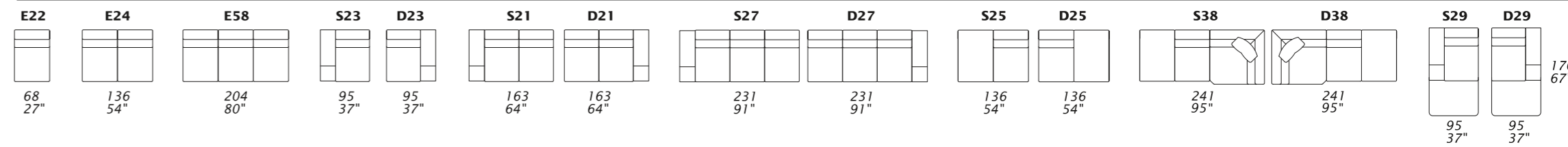

Y all items in group Y have the same seat width – tutti gli elementi del gruppo Y hanno lo stesso modulo di seduta

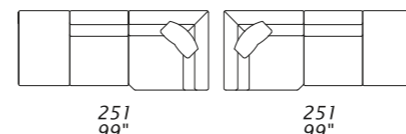
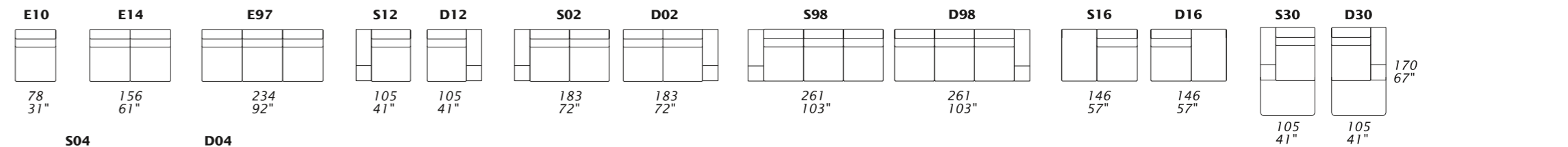

J all items in group J have the same seat width – tutti gli elementi del gruppo J hanno lo stesso modulo di seduta

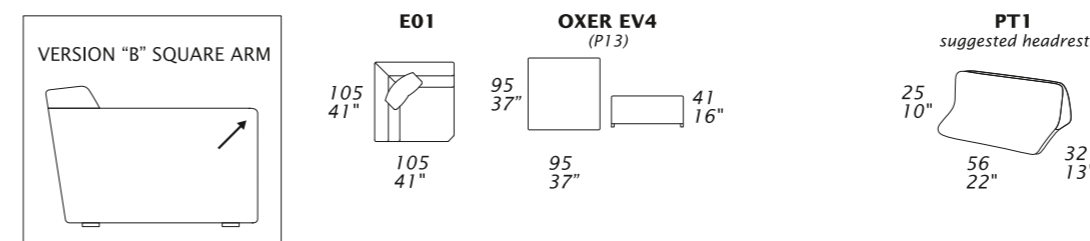
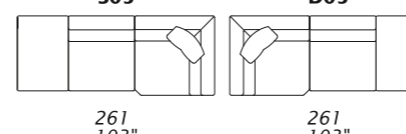
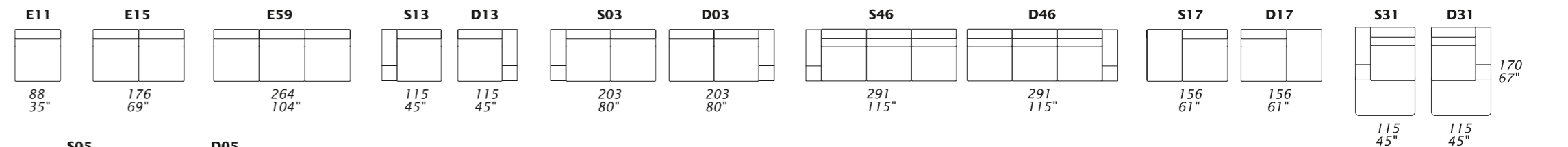

Dimensions: the first figure shows sizes in centimeters, the second in inches.
Each piece is made by hand and has its own uniqueness. Measures may vary with a tolerance up to 3%.
Mixing above groups (X - Y - J) will create sectionals with different seat widths.
Corner piece E01 is an odd piece and can be used with all above groups X - Y - J.
Seat depth 64 cm - 25".

TUXEDO

Design Giuseppe Viganò

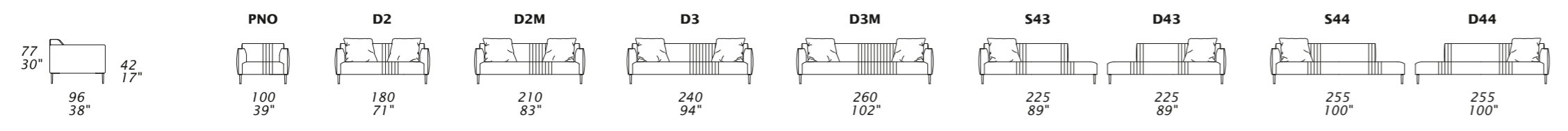

X all items in group X have the same seat width – tutti gli elementi del gruppo X hanno lo stesso modulo di seduta

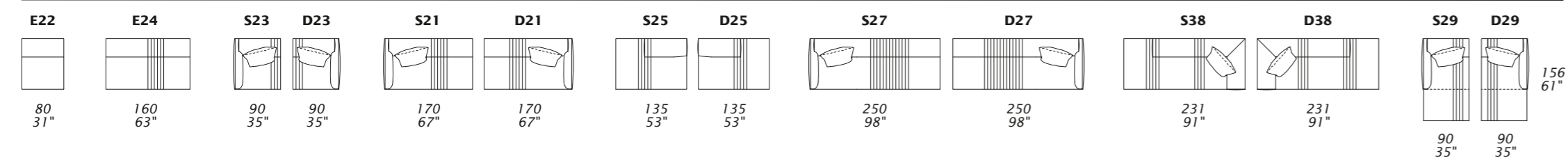

Y all items in group Y have the same seat width – tutti gli elementi del gruppo Y hanno lo stesso modulo di seduta

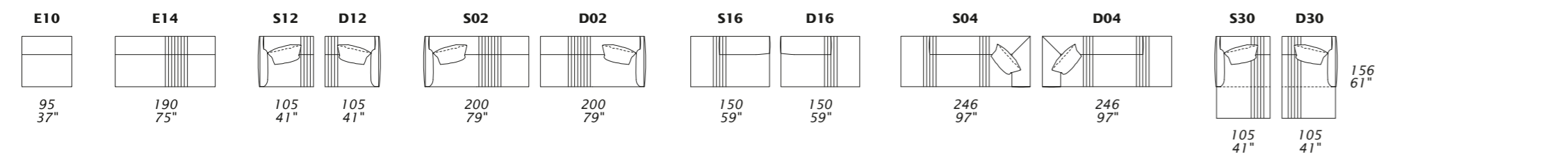

J all items in group J have the same seat width – tutti gli elementi del gruppo J hanno lo stesso modulo di seduta

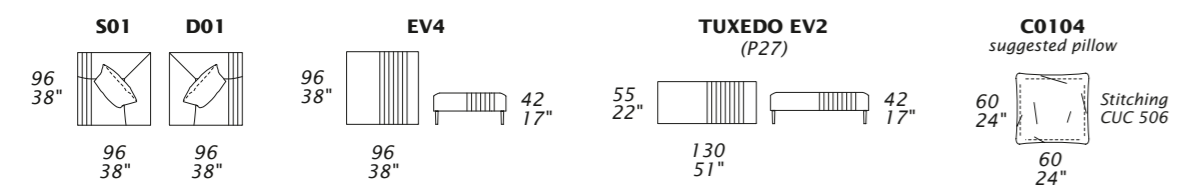
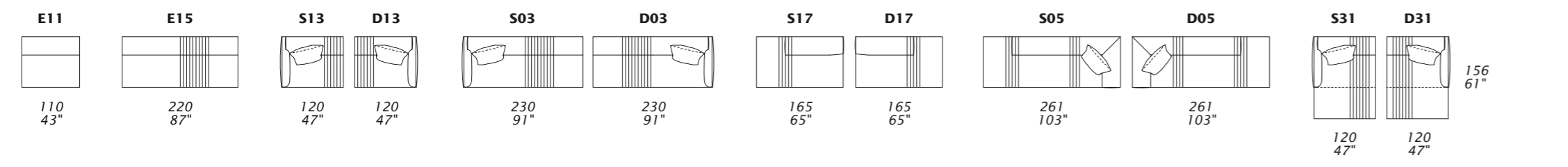

Dimensions: the first figure shows sizes in centimeters, the second in inches.
 Each piece is made by hand and has its own uniqueness. Measures may vary with a tolerance up to 3%.
 Mixing above groups (X - Y - J) will create sectionals with different seat widths.
 Corner piece E01 is an odd piece and can be used with all above groups X - Y - J.
 Seat depth 60 cm - 24".

VESSEL

Design Giuseppe Viganò

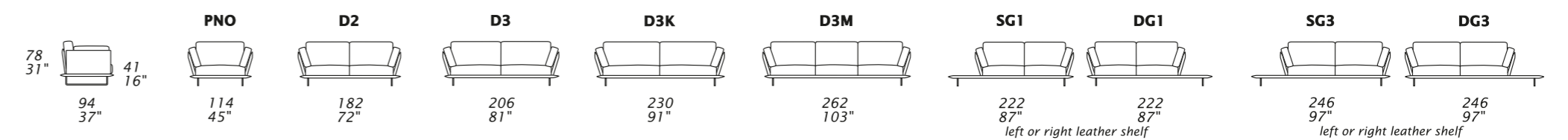

X all items in group X have the same seat width – tutti gli elementi del gruppo X hanno lo stesso modulo di seduta

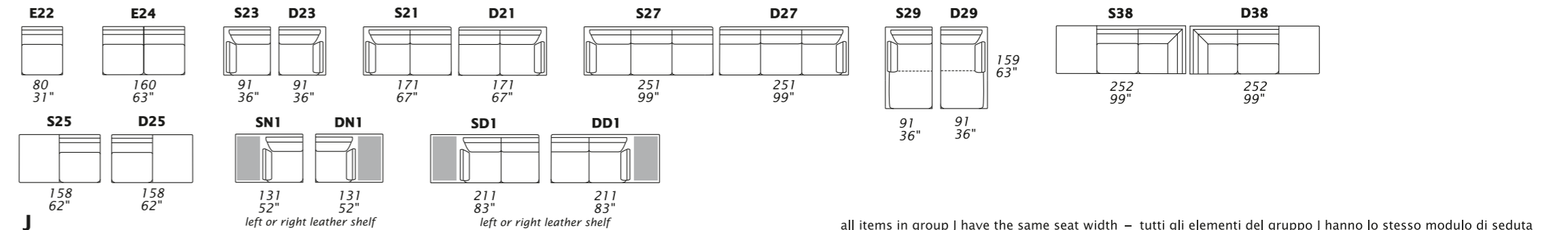

J all items in group J have the same seat width – tutti gli elementi del gruppo J hanno lo stesso modulo di seduta

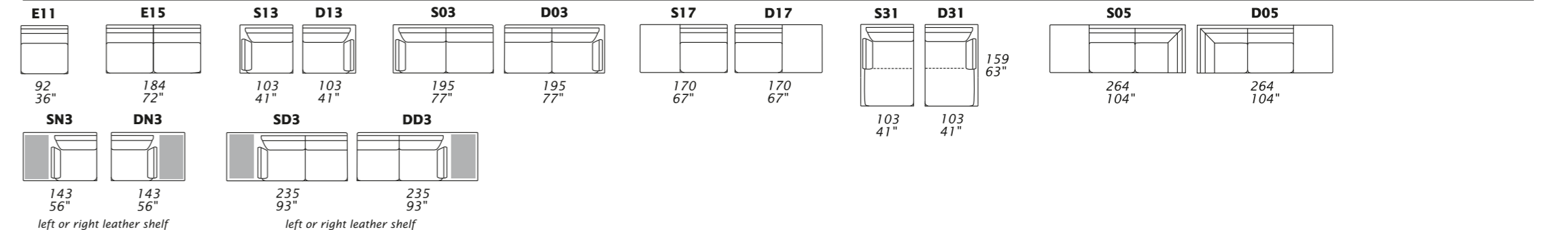

K all items in group K have the same seat width – tutti gli elementi del gruppo K hanno lo stesso modulo di seduta

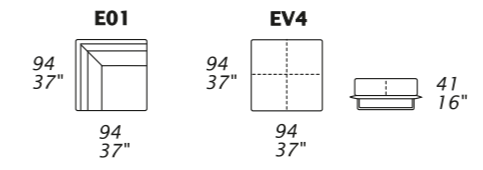
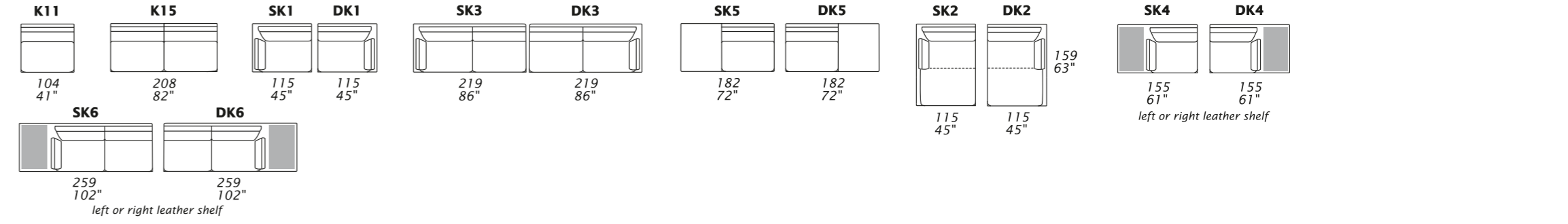

Dimensions: the first figure shows sizes in centimeters, the second in inches.
 Each piece is made by hand and has its own uniqueness. Measures may vary with a tolerance up to 3%.
 Mixing above groups (X - J - K) will create sectionals with different seat widths.
 Corner piece E01 is an odd piece and can be used with all above groups X - J - K.
 Seat depth 60 cm - 24".

WAFER

Design Giuseppe Viganò

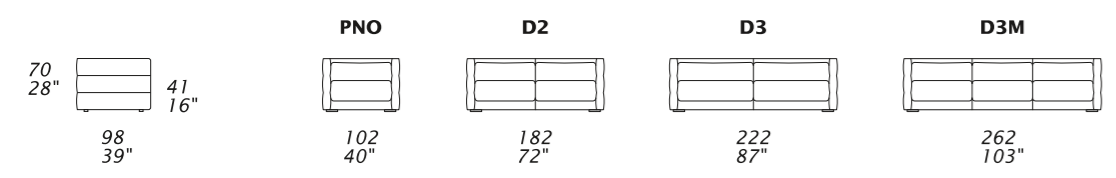

X all items in group X have the same seat width – tutti gli elementi del gruppo X hanno lo stesso modulo di seduta

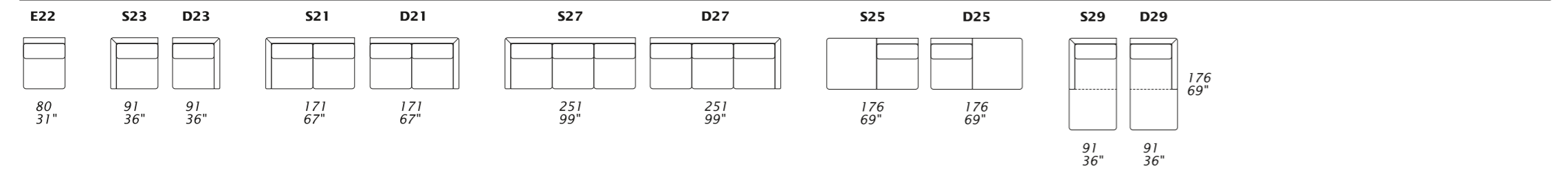

J all items in group J have the same seat width – tutti gli elementi del gruppo J hanno lo stesso modulo di seduta

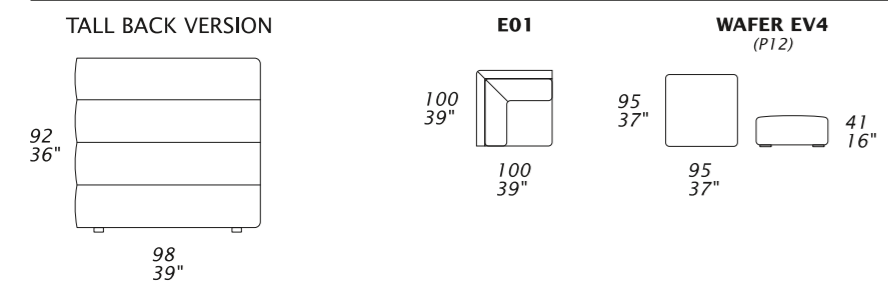
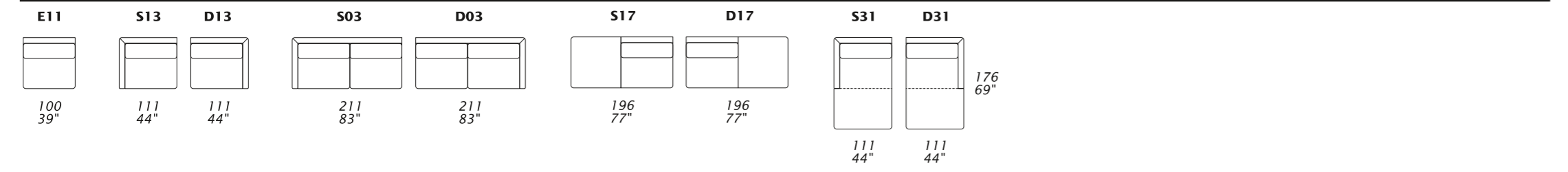

Dimensions: the first figure shows sizes in centimeters, the second in inches.
 Each piece is made by hand and has its own uniqueness. Measures may vary with a tolerance up to 3%.
 Mixing above groups (X - J) will create sectionals with different seat widths.
 Corner piece E01 is an odd piece and can be used with all above groups X - J.
 Seat depth 58 cm - 23".

WOLF

Design Giuseppe Viganò

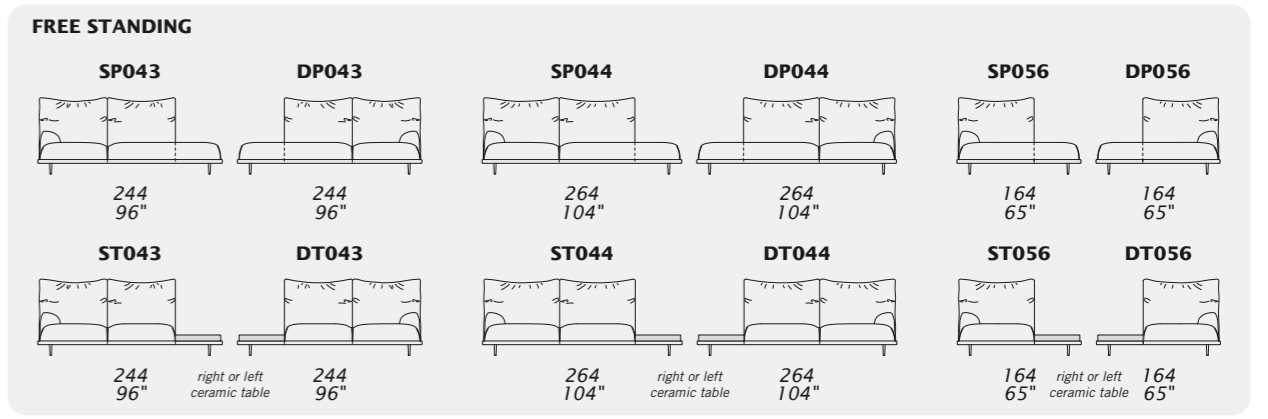
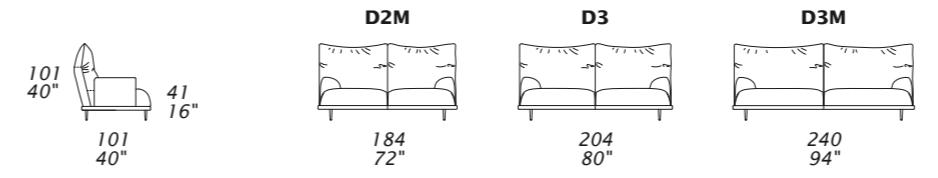

Y all items in group Y have the same seat width – tutti gli elementi del gruppo Y hanno lo stesso modulo di seduta

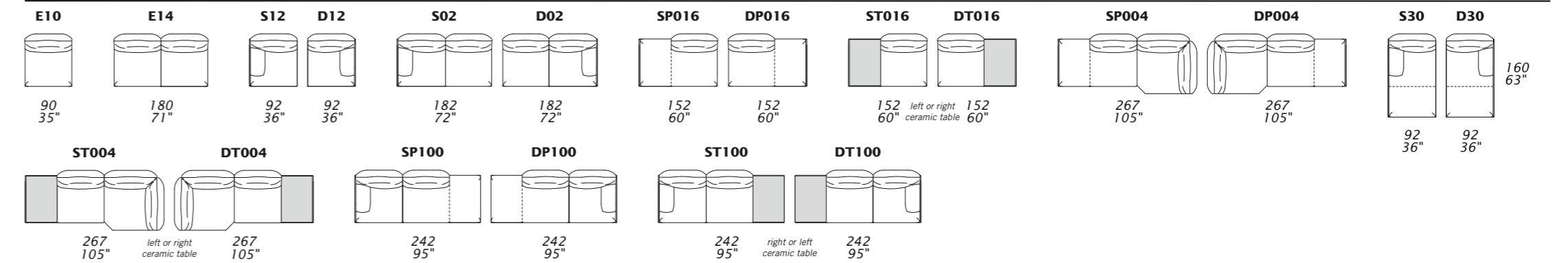

J all items in group J have the same seat width – tutti gli elementi del gruppo J hanno lo stesso modulo di seduta

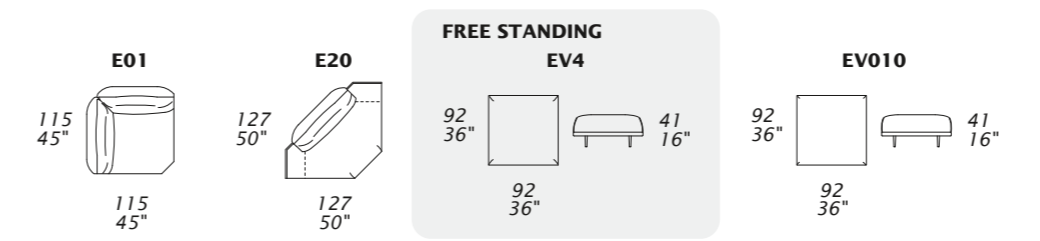
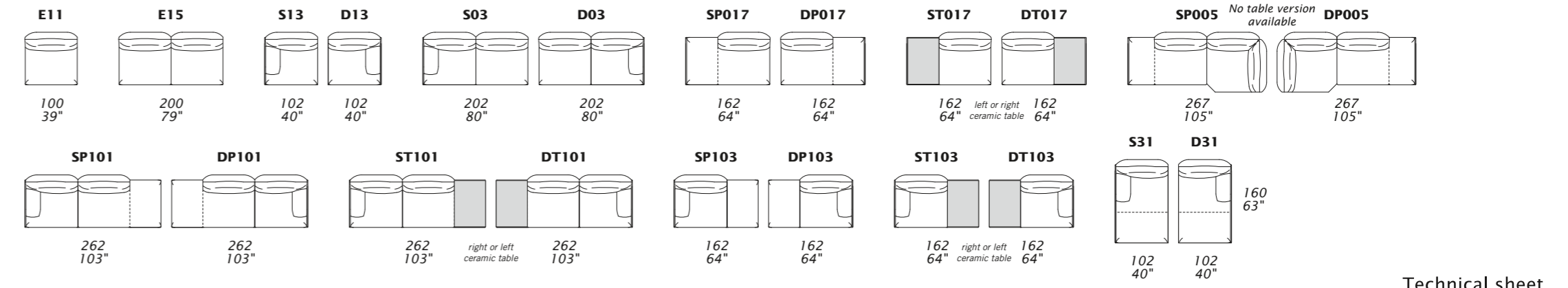

Dimensions: the first figure shows sizes in centimeters, the second in inches.
 Each piece is made by hand and has its own uniqueness. Measures may vary with a tolerance up to 3%.
 Mixing above groups (Y - J) will create sectionals with different seat widths.
 Corner pieces E20 and E01 are odd pieces and can be used with all above groups Y - J.
 Piece SP005/DP005 do not have a version with table instead of pouf.
 Seat depth 65 cm - 26".

BAG NIGHT

Design Giuseppe Viganò

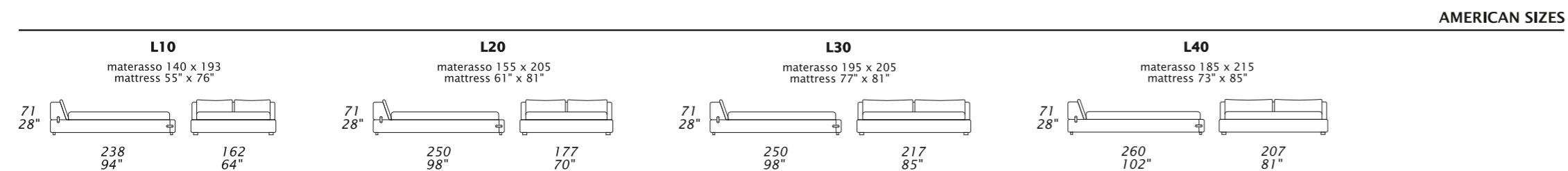
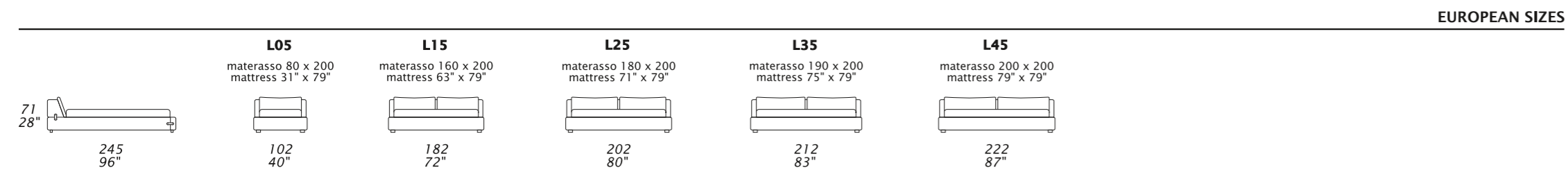

Dimensions: the first figure shows sizes in centimeters, the second in inches.
 Each piece is made by hand and has its own uniqueness. Measures may vary with a tolerance up to 3%.
 Base height 28 cm - 11".
 Wood legs, height 4 cm - 1" 1/2.

Technical sheet

CROSSOVER NIGHT

Design Giuseppe Viganò

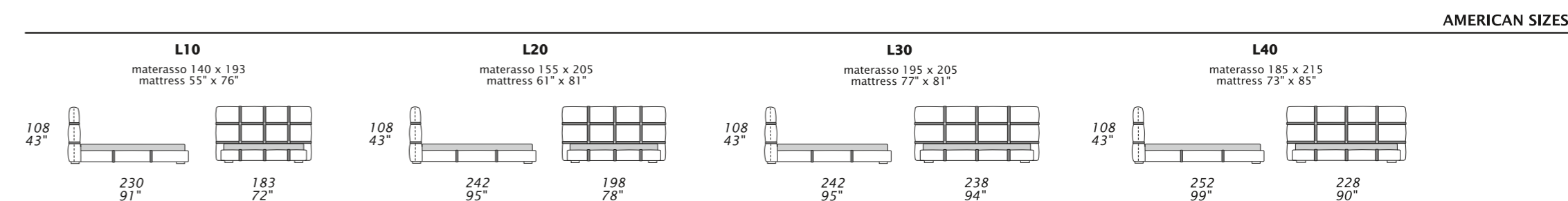
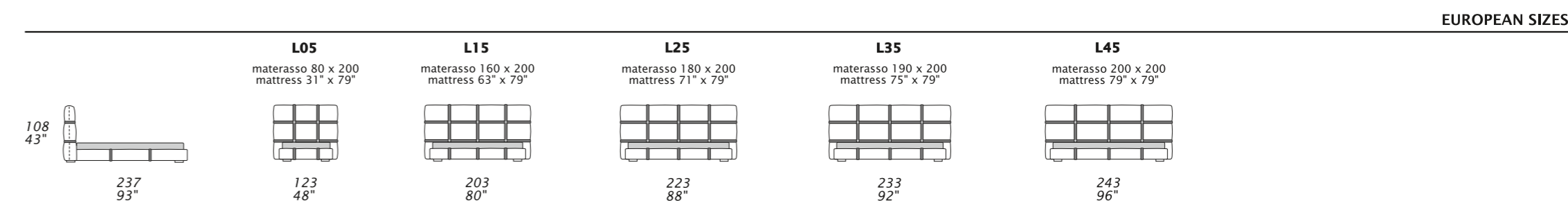

Dimensions: the first figure shows sizes in centimeters, the second in inches.
 Each piece is made by hand and has its own uniqueness. Measures may vary with a tolerance up to 3%.
 Base height 31 cm - 12".
 Wood legs, height 4 cm - 1" 1/2.

Technical sheet

JACK NIGHT

Design Giuseppe Viganò

EUROPEAN SIZES

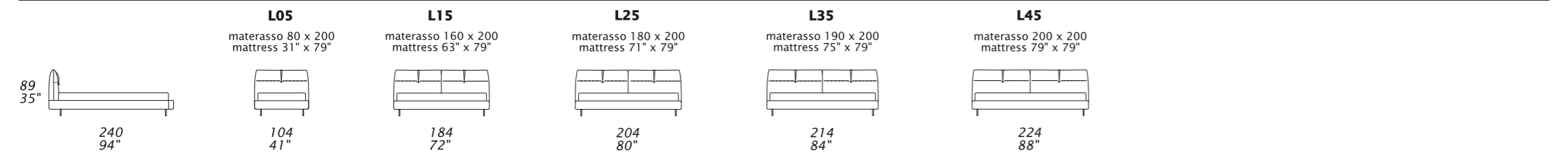

AMERICAN SIZES

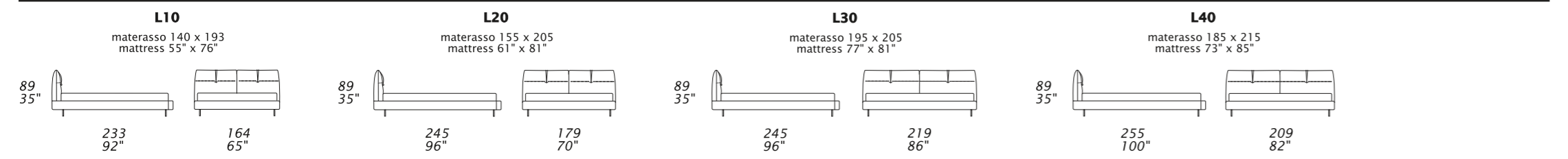

Dimensions: the first figure shows sizes in centimeters, the second in inches.
 Each piece is made by hand and has its own uniqueness. Measures may vary with a tolerance up to 3%.
 Base height 27 cm - 11".
 Chrome or dark chrome-titanio, height 15 cm - 6".

JAZZ NIGHT

Design Giuseppe Viganò

L50

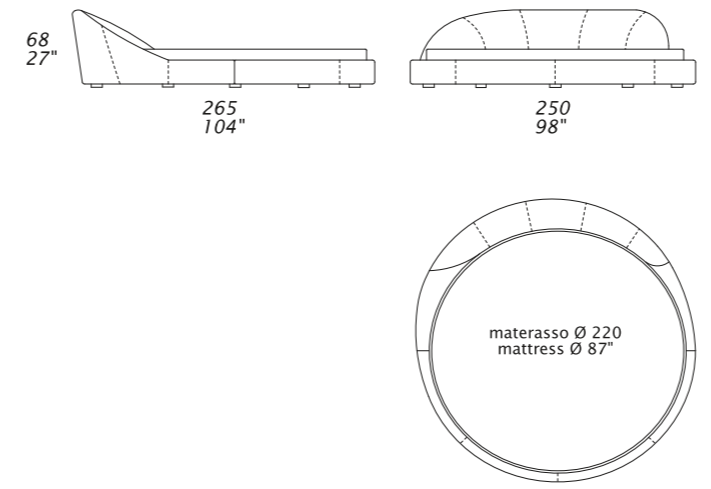

Dimensions: the first figure shows sizes in centimeters, the second in inches.
 Each piece is made by hand and has its own uniqueness. Measures may vary with a tolerance up to 3%.
 Base height 25 cm - 10".
 Wood legs, height 4 cm - 1" 1/2".

KONG NIGHT

Design Giuseppe Viganò

EUROPEAN SIZES

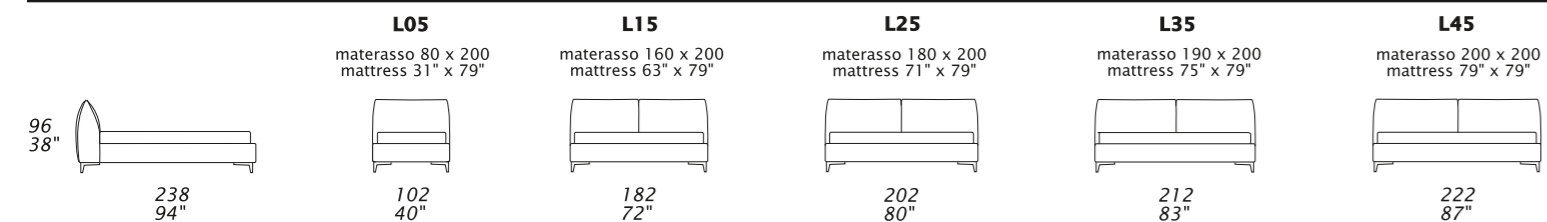

AMERICAN SIZES

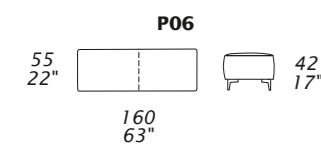
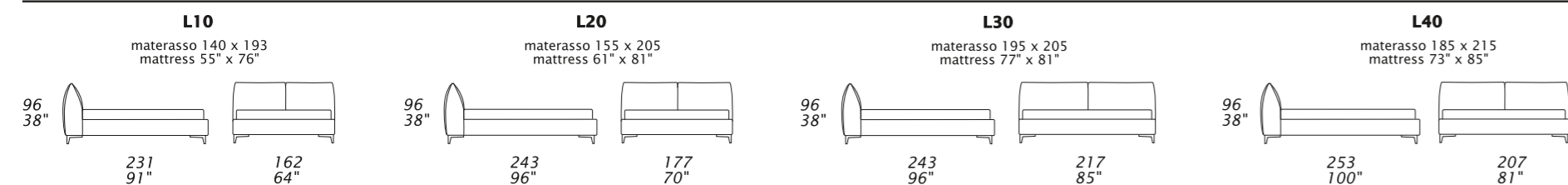

Dimensions: the first figure shows sizes in centimeters, the second in inches.
 Each piece is made by hand and has its own uniqueness. Measures may vary with a tolerance up to 3%.
 Base height 36 cm - 14".
 Wood legs, height 13 cm - 5".

Technical sheet

MARILYN NIGHT

Design Giuseppe Viganò

EUROPEAN SIZES

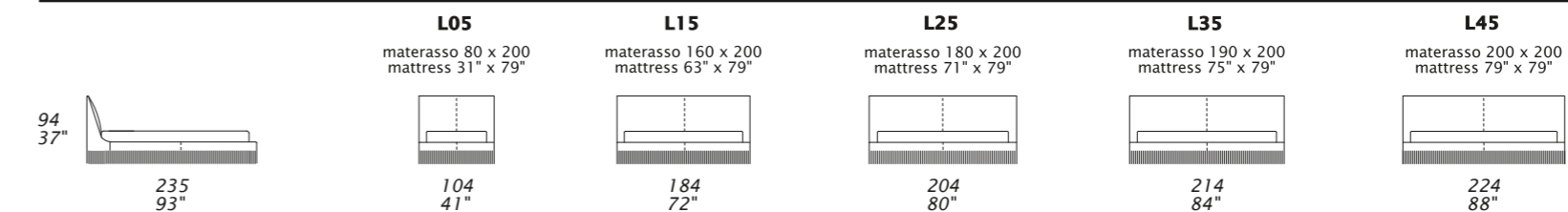

AMERICAN SIZES

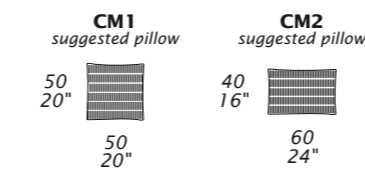
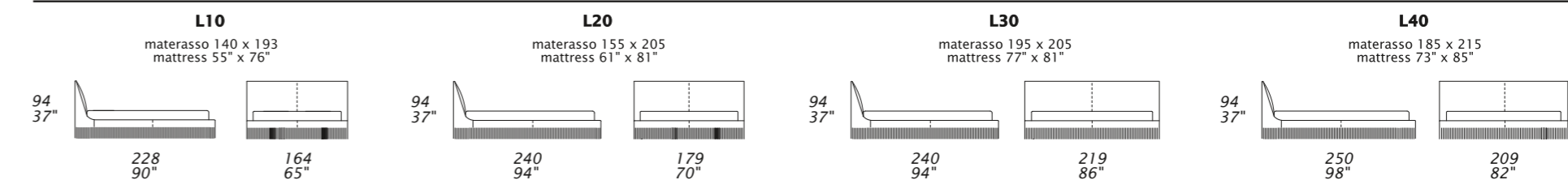

Dimensions: the first figure shows sizes in centimeters, the second in inches.
 Each piece is made by hand and has its own uniqueness. Measures may vary with a tolerance up to 3%.
 Base height 31 cm - 12".
 Metal legs, height 19 cm - 7".

Technical sheet

MARLON NIGHT

Design Giuseppe Viganò

EUROPEAN SIZES

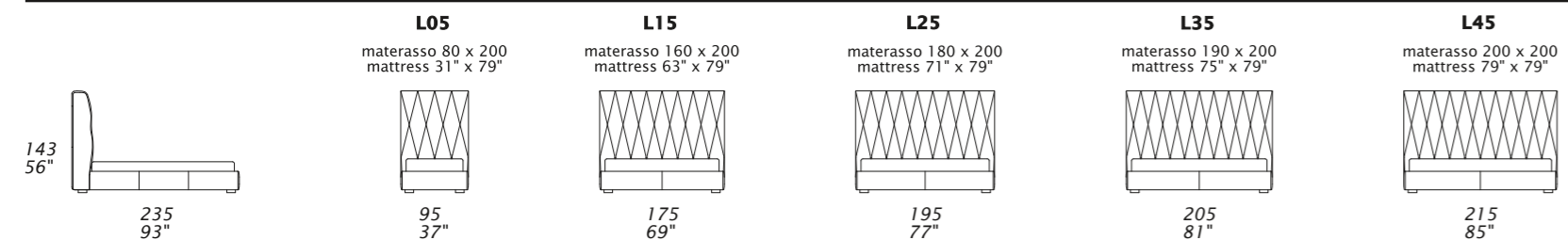

AMERICAN SIZES

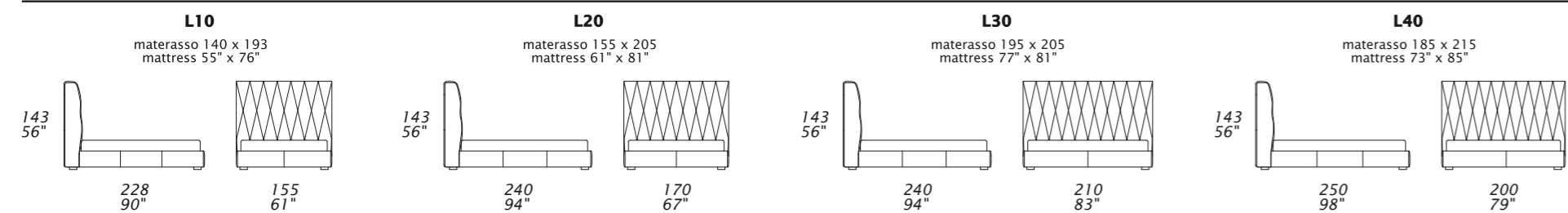

Dimensions: the first figure shows sizes in centimeters, the second in inches.
Each piece is made by hand and has its own uniqueness. Measures may vary with a tolerance up to 3%.
Base height 30 cm - 12".
Wood legs, height 4 cm - 1" 1/2.

Technical sheet

McQUEEN NIGHT

Design Giuseppe Viganò

EUROPEAN SIZES

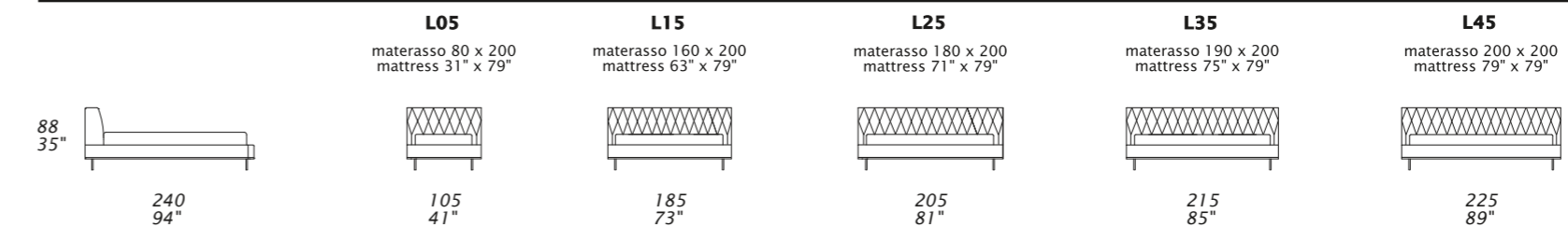

AMERICAN SIZES

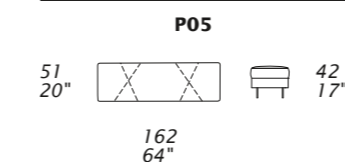
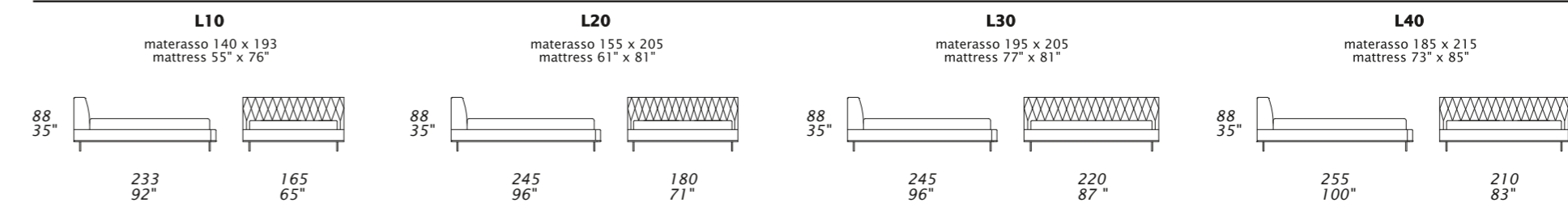

Dimensions: the first figure shows sizes in centimeters, the second in inches.
Each piece is made by hand and has its own uniqueness. Measures may vary with a tolerance up to 3%.
Base height 31 cm - 12".
Chrome or dark chrome-titanio, height 14 cm - 6".

Technical sheet

OXER NIGHT

Design Giuseppe Viganò

EUROPEAN SIZES

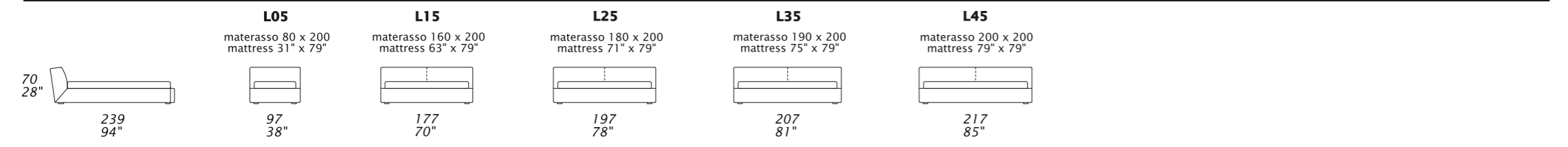

AMERICAN SIZES

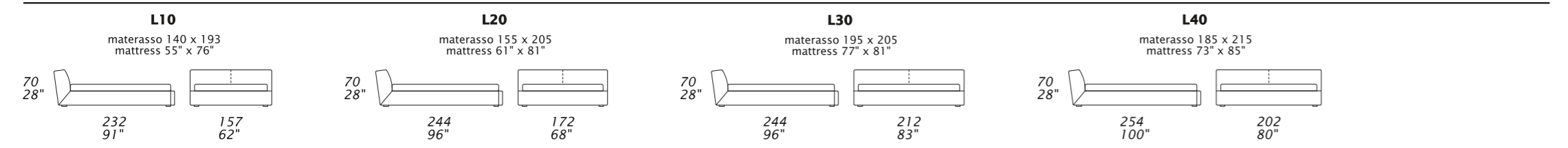

TALL HEADBOARD VERSION

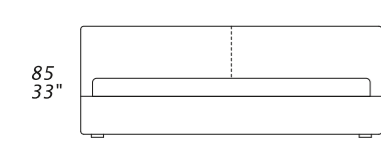

Dimensions: the first figure shows sizes in centimeters, the second in inches.
 Each piece is made by hand and has its own uniqueness. Measures may vary with a tolerance up to 3%.
 Base height 28 cm - 11".
 Wood legs, height 3 cm - 1" 1/4.

SUITE NIGHT

Design Giuseppe Viganò

EUROPEAN SIZES

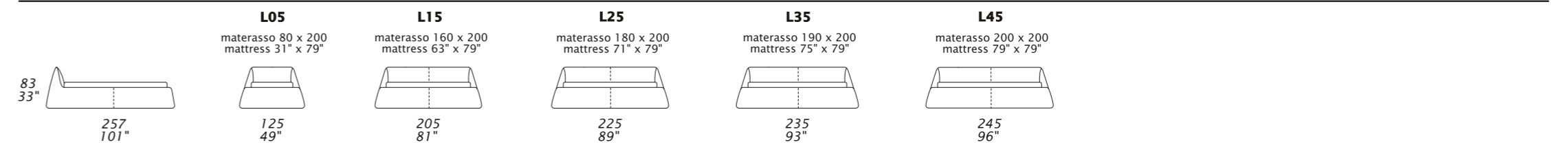

AMERICAN SIZES

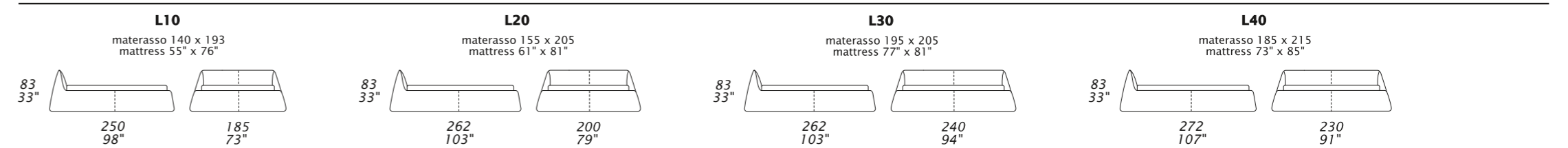

CH

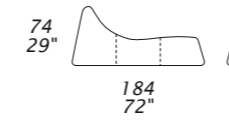

CHL

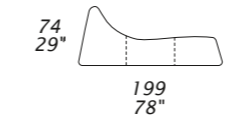

RA1

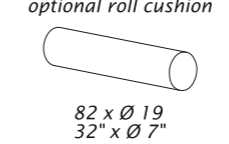

Dimensions: the first figure shows sizes in centimeters, the second in inches.
 Each piece is made by hand and has its own uniqueness. Measures may vary with a tolerance up to 3%.
 Base height 40 cm - 16".
 Wood legs, height 3 cm - 1" 1/4.

WAFER NIGHT

Design Giuseppe Viganò

EUROPEAN SIZES

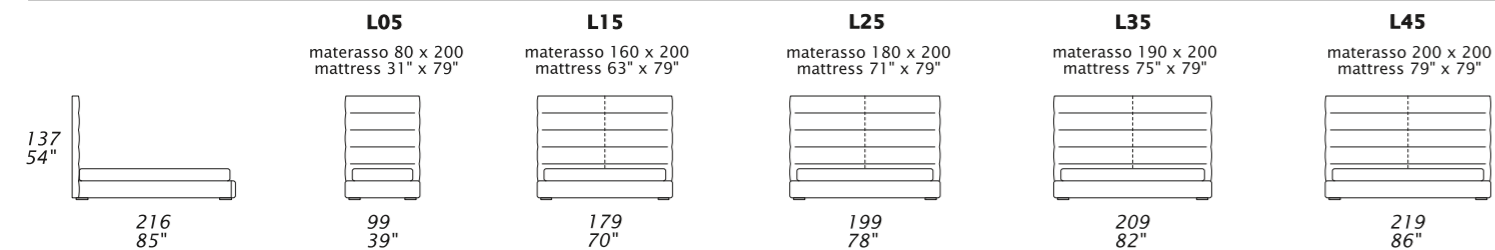

AMERICAN SIZES

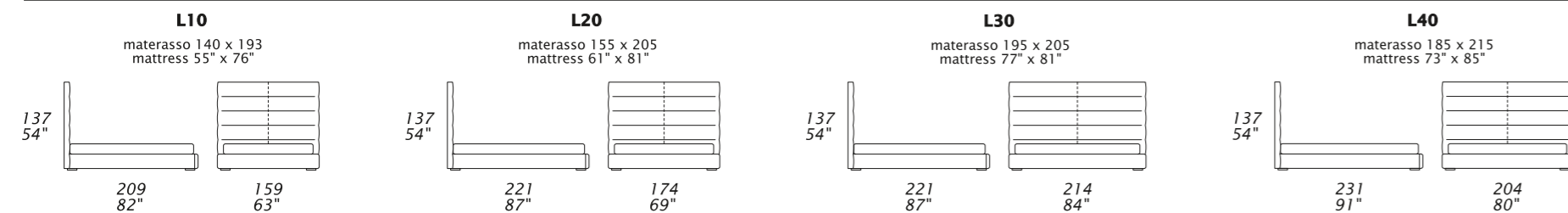

LOW HEADBOARD VERSION

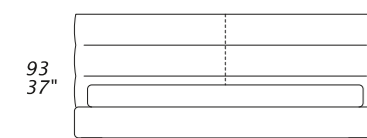

Dimensions: the first figure shows sizes in centimeters, the second in inches.
 Each piece is made by hand and has its own uniqueness. Measures may vary with a tolerance up to 3%.
 Base height 27 cm - 11".
 Wood legs, height 4,5 cm - 1" 1/2.

Technical sheet

ZIPPER NIGHT

Design Giuseppe Viganò

EUROPEAN SIZES

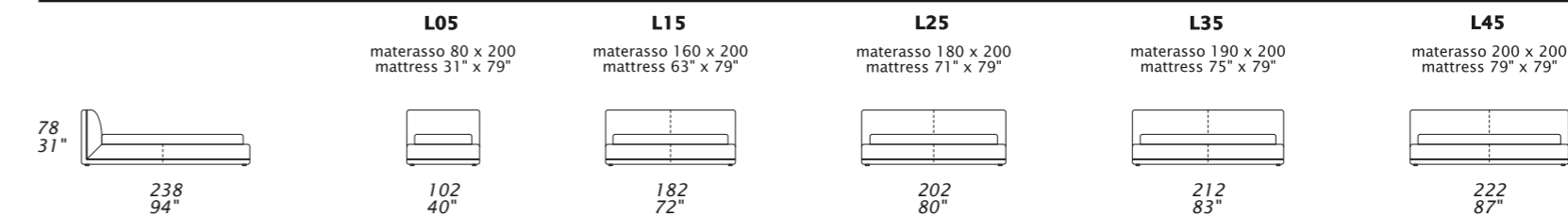

AMERICAN SIZES

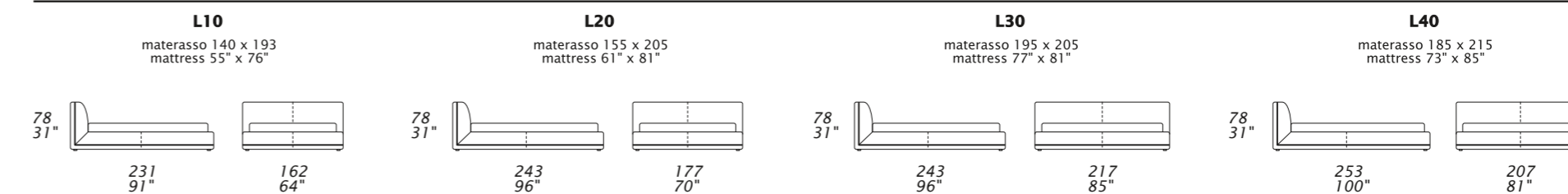

Dimensions: the first figure shows sizes in centimeters, the second in inches.
 Each piece is made by hand and has its own uniqueness. Measures may vary with a tolerance up to 3%.
 Base height 29 cm - 11".
 Wood Legs, height 3,5 cm - 1" 1/2.

Technical sheet

CHARLOTTE

Design Giuseppe Viganò

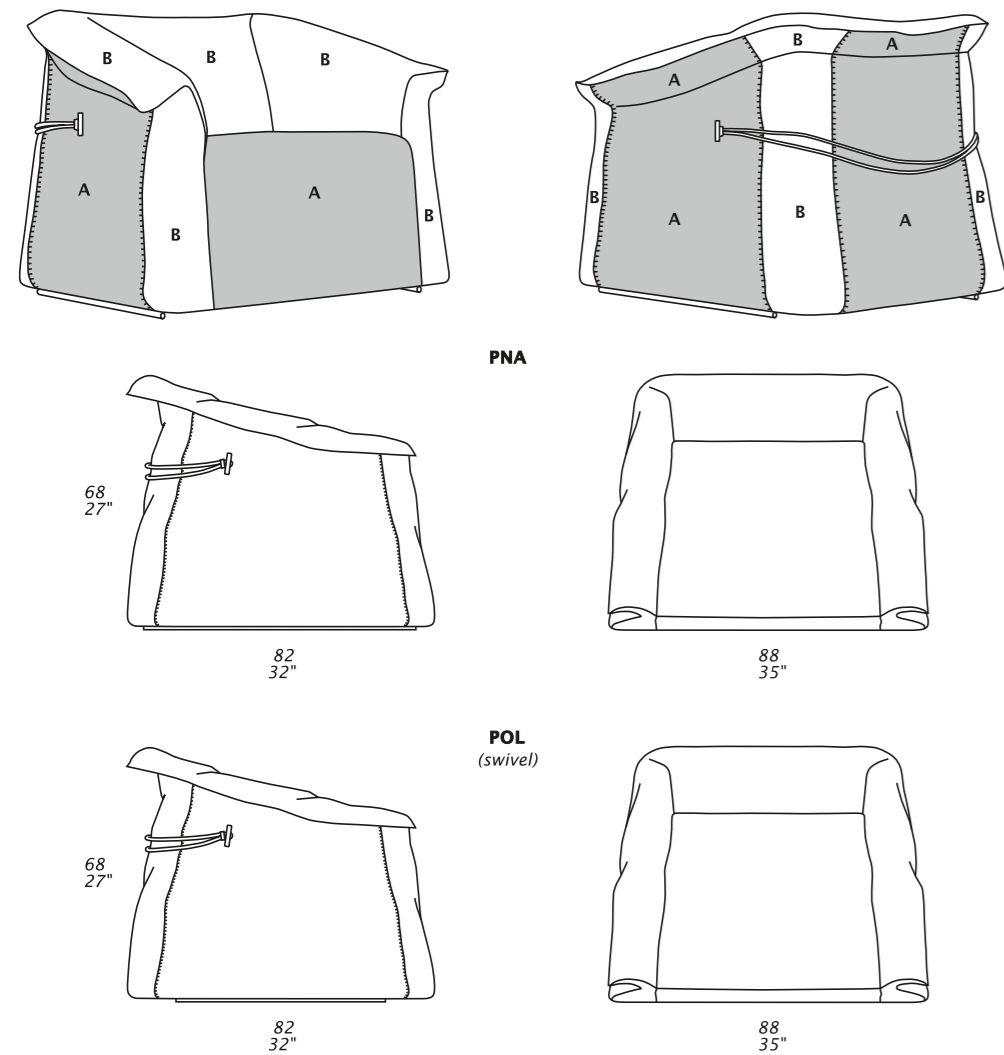

Dimensions: the first figure shows sizes in centimeters, the second in inches.
 Each piece is made by hand and has its own uniqueness. Measures may vary with a tolerance up to 3%.
 Strings in leather only.
 Seat depth 53 cm - 21".
 Seat height 39 cm - 15".

Technical sheet

CROSSOVER

Design Giuseppe Viganò

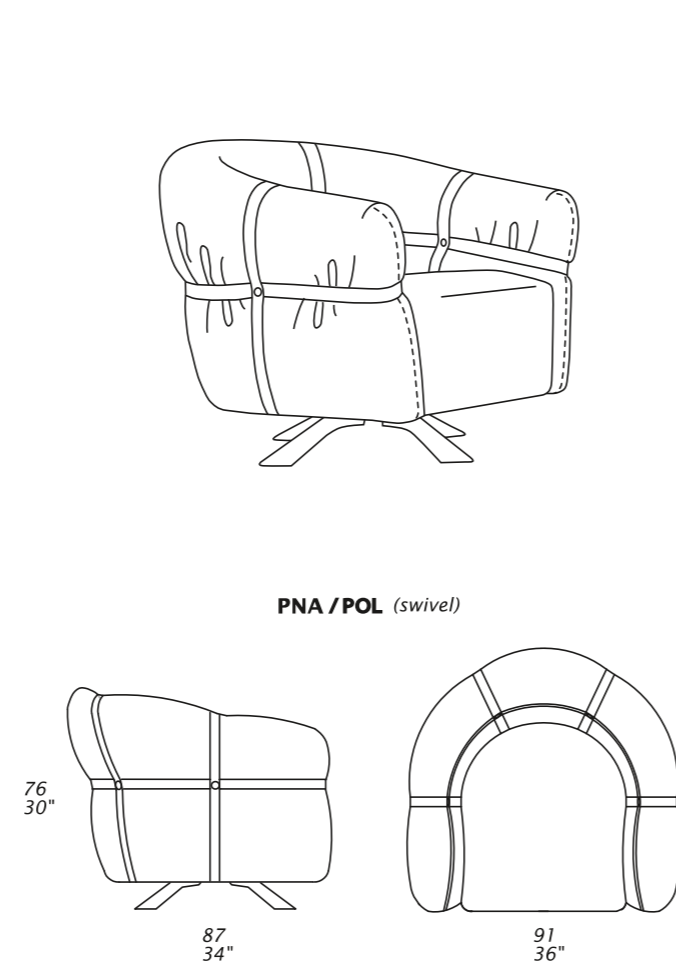

Dimensions: the first figure shows sizes in centimeters, the second in inches.
 Each piece is made by hand and has its own uniqueness. Measures may vary with a tolerance up to 3%.
 Seat depth 56 cm - 22".
 Seat height 42 cm - 17".

Technical sheet

DEAN

Design Giuseppe Viganò

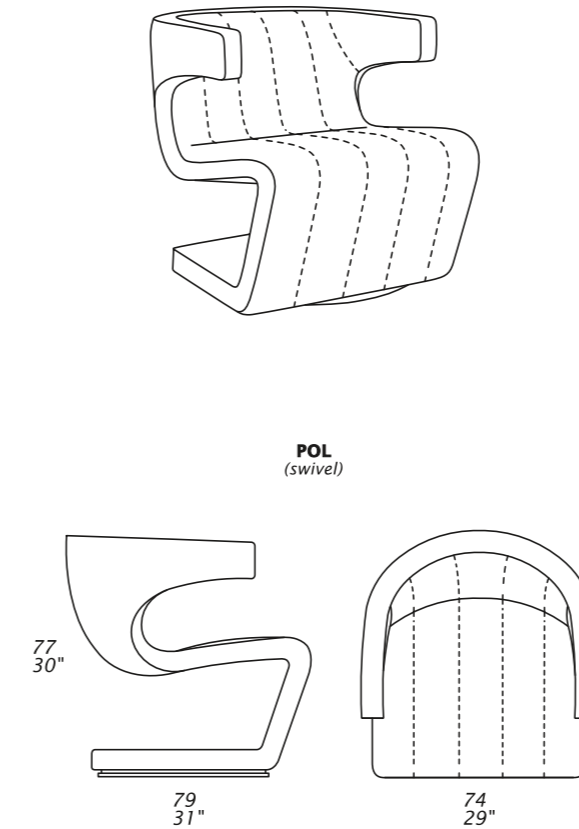

Dimensions: the first figure shows sizes in centimeters, the second in inches.
 Each piece is made by hand and has its own uniqueness. Measures may vary with a tolerance up to 3%.
 Seat depth 49 cm - 19".
 Seat height 44 cm - 17".

Technical sheet

EDWIN

Design Giuseppe Viganò

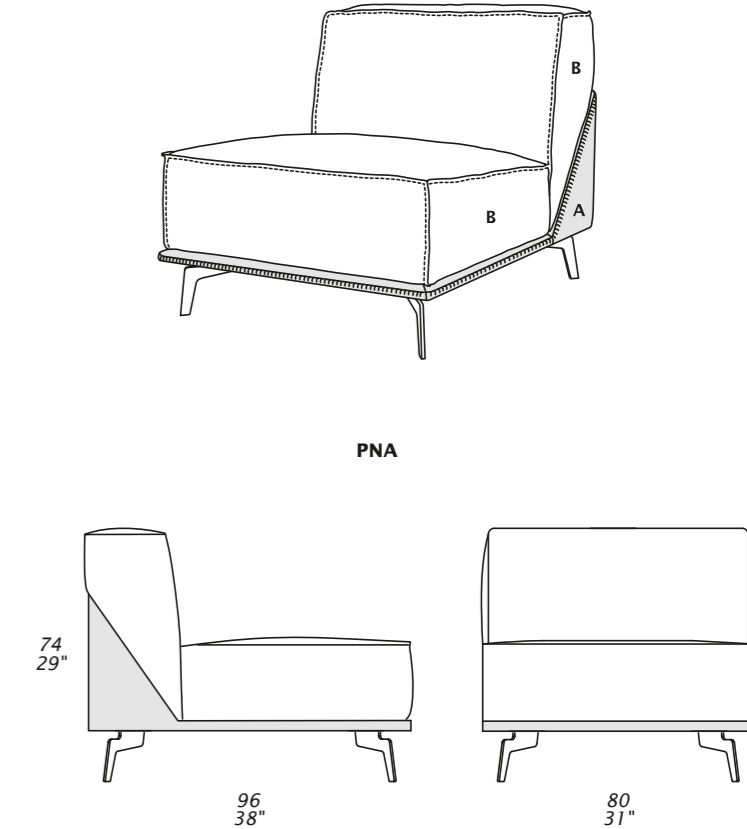

Dimensions: the first figure shows sizes in centimeters, the second in inches.
 Each piece is made by hand and has its own uniqueness. Measures may vary with a tolerance up to 3%.
 Seat depth 62 cm - 24".
 Seat height 44 cm - 17".

Technical sheet

FRINGE

Design Giuseppe Viganò

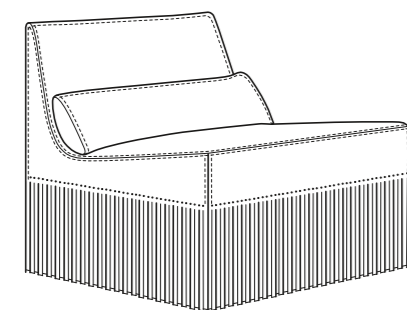

PNA

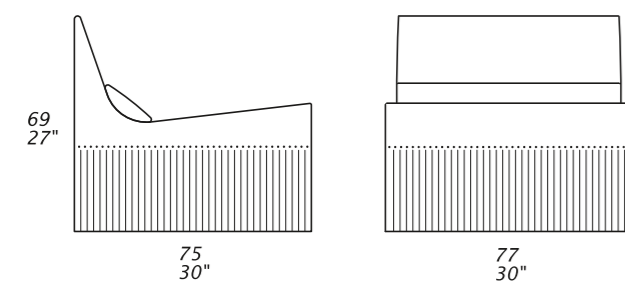

Dimensions: the first figure shows sizes in centimeters, the second in inches.
Each piece is made by hand and has its own uniqueness. Measures may vary with a tolerance up to 3%.
Seat depth 50 cm - 20".
Seat height 41 cm - 16".

Technical sheet

GEM

Design Giuseppe Viganò

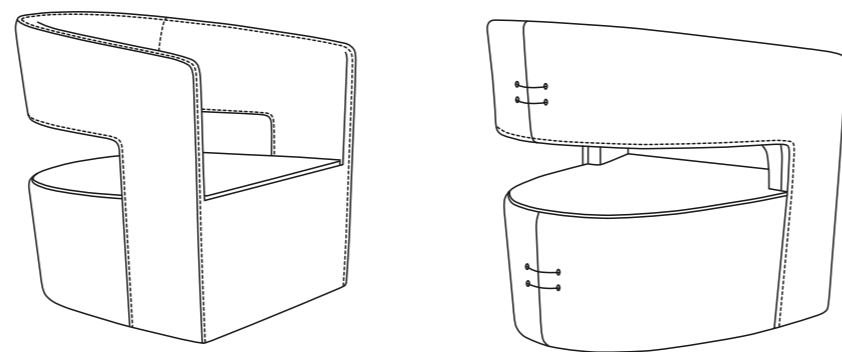

PNA

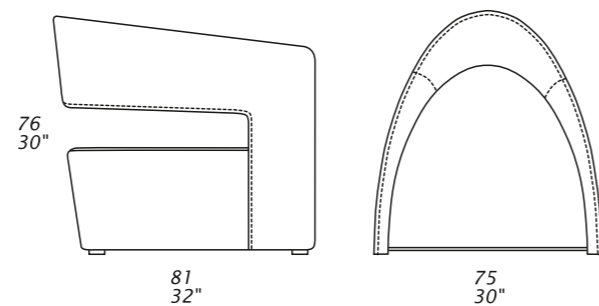
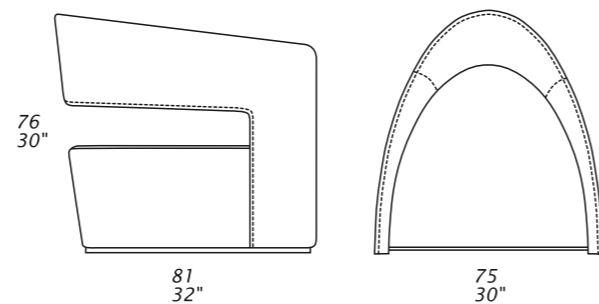
POL
(swivel)

Dimensions: the first figure shows sizes in centimeters, the second in inches.
Each piece is made by hand and has its own uniqueness. Measures may vary with a tolerance up to 3%.
Seat depth 59 cm - 23".
Seat height 40 cm - 16".

Technical sheet

GLOSS

Design Giuseppe Viganò

STANDARD FEATURES

- POL: PAINTED FRAME AND METAL SWIVEL BASE AVAILABLE IN:
METALLIC GREY, METALLIC ANTHRACITE, SIGNAL WHITE, SILK GREY, WINE RED, GREY BROWN, JET BLACK

- POS: FRAME COVERED WITH LEATHER AND METAL SWIVEL BASE AVAILABLE IN:
METALLIC GREY, METALLIC ANTHRACITE, SIGNAL WHITE, SILK GREY, WINE RED, GREY BROWN, JET BLACK

NOTE

- AVAILABLE CHROME OR DARK CHROME-TITANIO METAL SWIVEL BASE

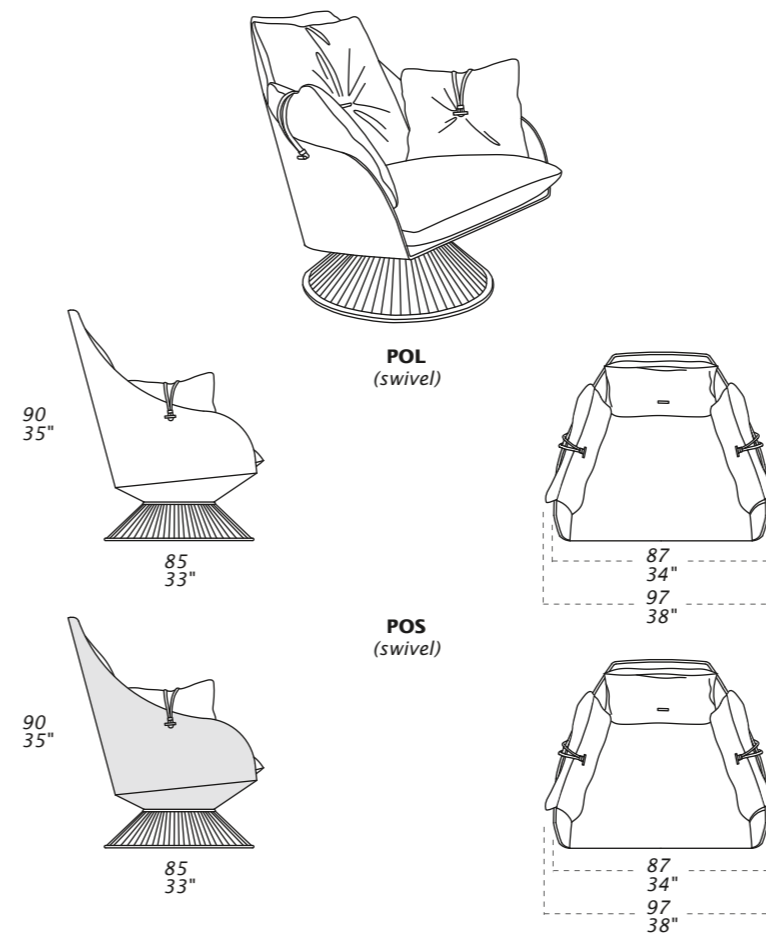
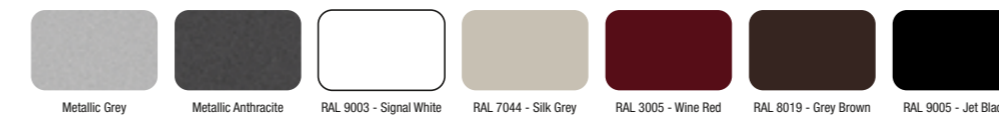
POL
(swivel)POS
(swivel)

Dimensions: the first figure shows sizes in centimeters, the second in inches.
Each piece is made by hand and has its own uniqueness. Measures may vary with a tolerance up to 3%.
Seat depth 61 cm - 24".
Seat height 44 cm - 17".

Technical sheet

HARLEY

Design Giuseppe Viganò

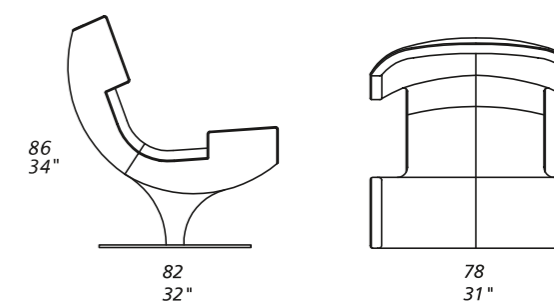
POL
(swivel)

Dimensions: the first figure shows sizes in centimeters, the second in inches.
Each piece is made by hand and has its own uniqueness. Measures may vary with a tolerance up to 3%.
Seat depth 54 cm - 21".
Seat height 41 cm - 16".

Technical sheet

LOBSTER

Design Giuseppe Viganò

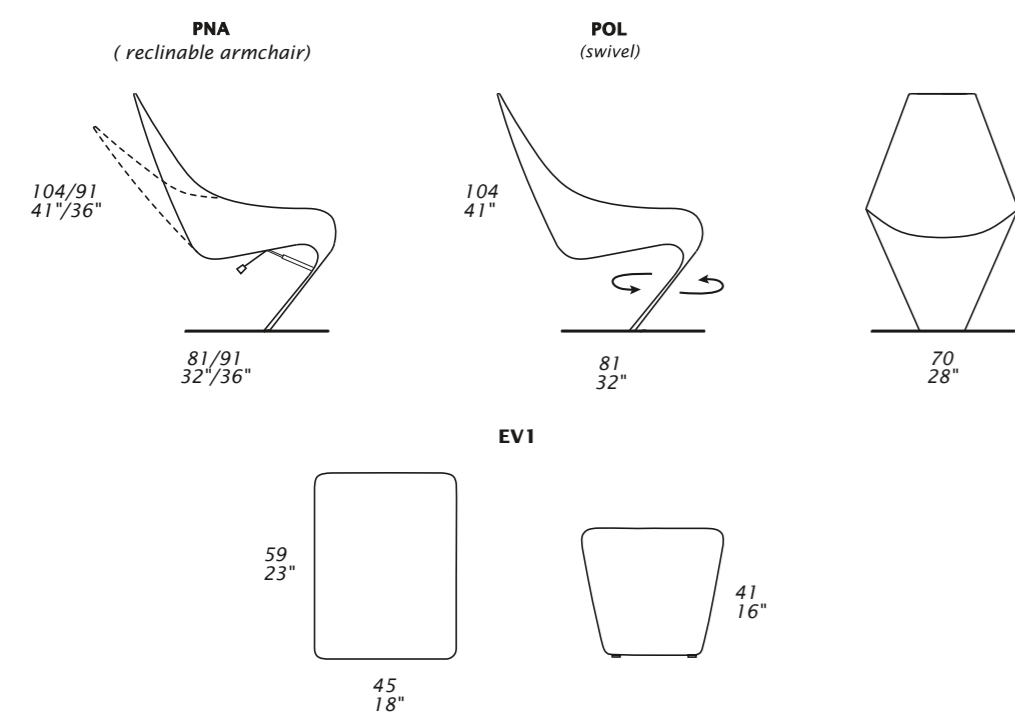

Dimensions: the first figure shows sizes in centimeters, the second in inches.
 Each piece is made by hand and has its own uniqueness. Measures may vary with a tolerance up to 3%.
 Seat depth 51 cm - 20".
 Seat height 42 cm - 17".

Technical sheet

LOLITA

Design Giuseppe Viganò

STANDARD FEATURES
 - LEGS AVAILABLE IN: CHROME, DARK CHROME-TITANIO, PAINTED METAL OR WOOD LEGS
 - WOOD LEGS FINISH: NOCE CANALETTO OR FRASSINO

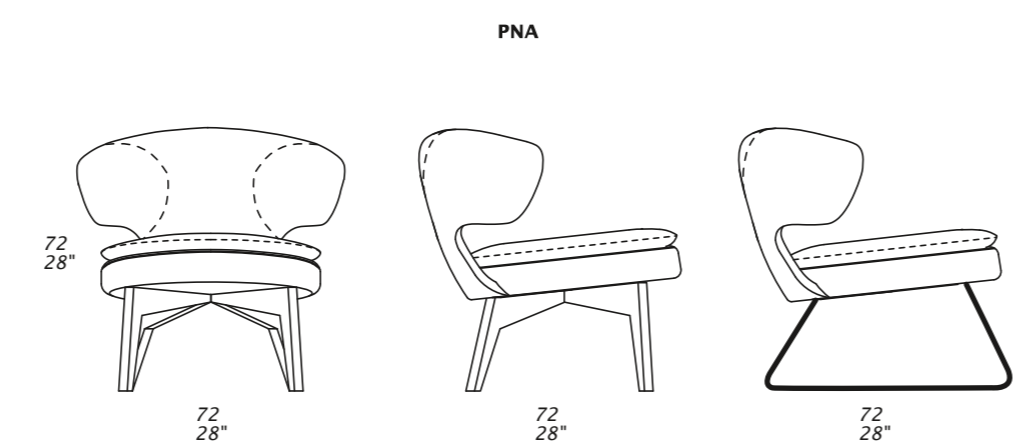
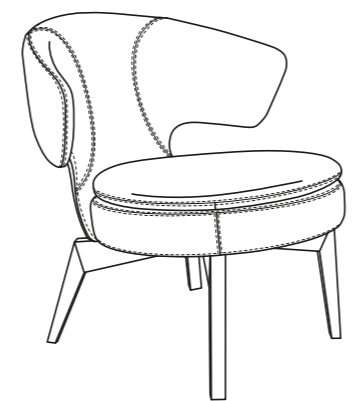

Dimensions: the first figure shows sizes in centimeters, the second in inches.
 Each piece is made by hand and has its own uniqueness. Measures may vary with a tolerance up to 3%.
 Seat depth 57 cm - 22".
 Seat height 43 cm - 17".

Technical sheet

SNOB

Design Giuseppe Viganò

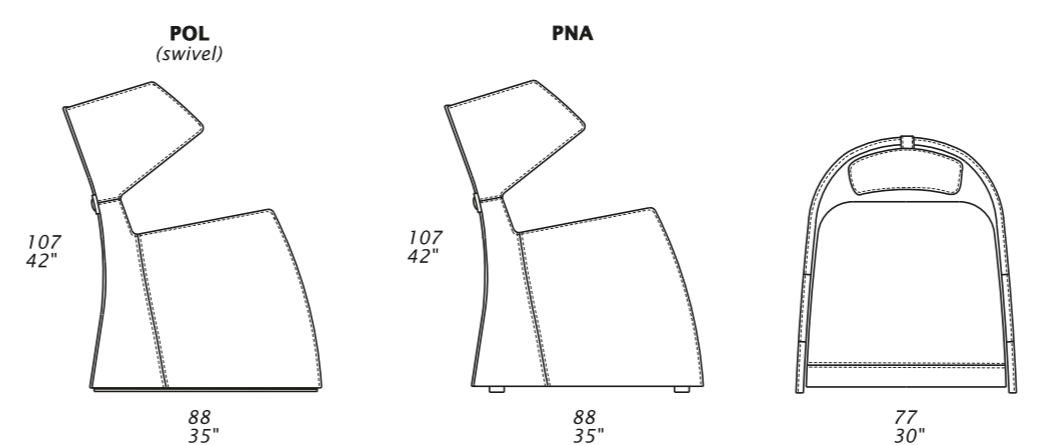
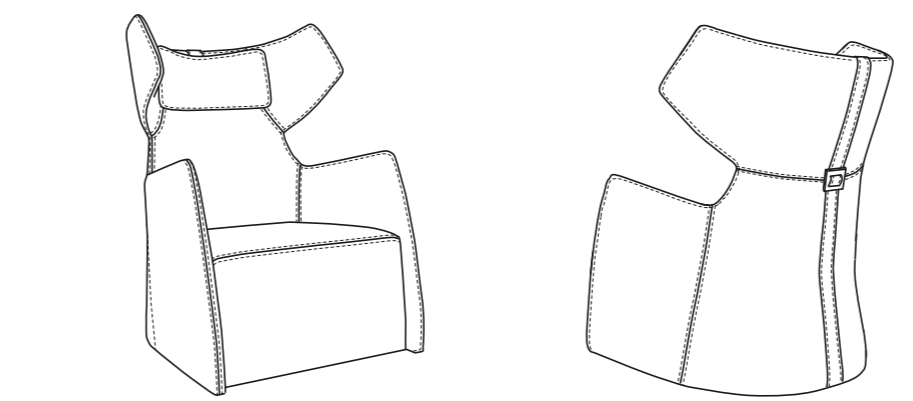

Dimensions: the first figure shows sizes in centimeters, the second in inches.
 Each piece is made by hand and has its own uniqueness. Measures may vary with a tolerance up to 3%.
 Seat depth 54 cm - 21".
 Seat height 41 cm - 16".

Technical sheet

TRENCH

Design Giuseppe Viganò

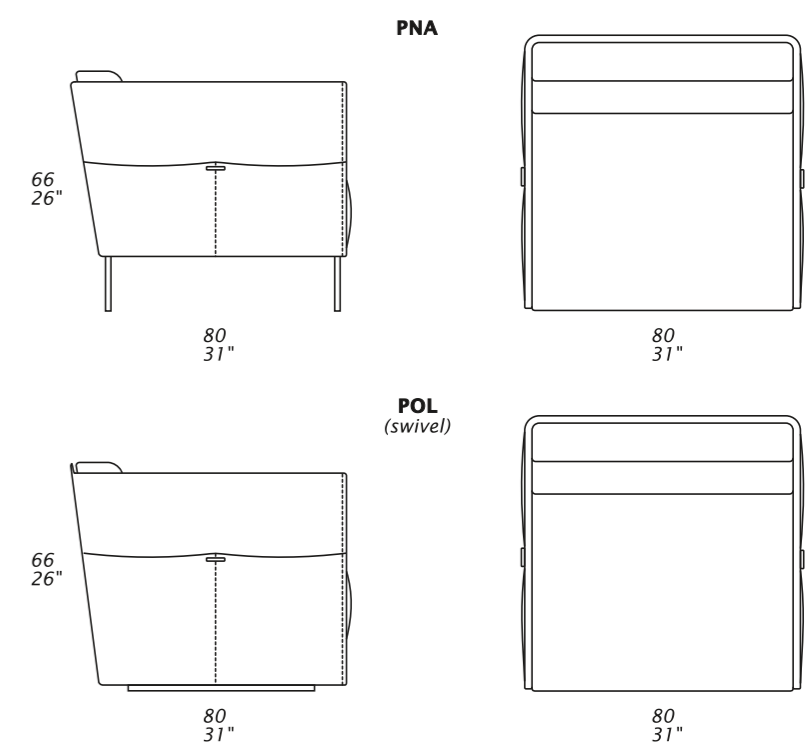
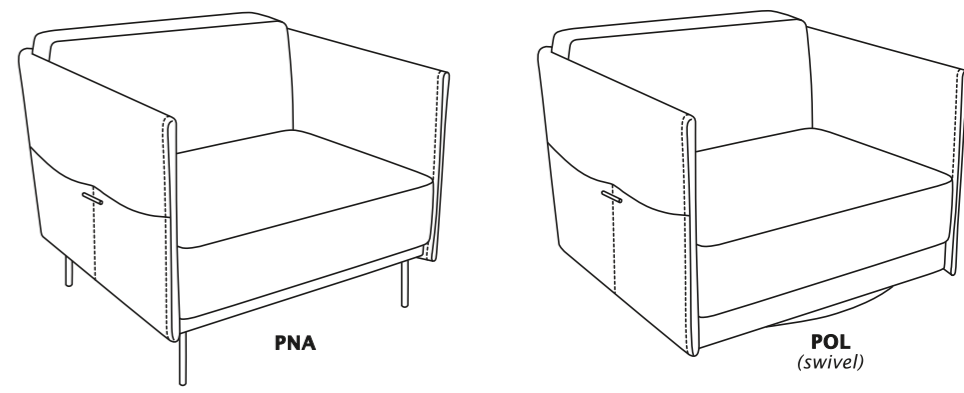

Dimensions: the first figure shows sizes in centimeters, the second in inches.
 Each piece is made by hand and has its own uniqueness. Measures may vary with a tolerance up to 3%.
 Seat depth 56 cm - 22".
 Seat height 41 cm - 16".

Technical sheet

COFFEE TABLES

Design Giuseppe Viganò

STANDARD FEATURES

- BASE AVAILABLE IN: CHROME, DARK CHROME-TITANIO, PAINTED METAL OR COVERED WITH LEATHER
- BUCKLE AVAILABLE IN: CHROME, DARK CHROME-TITANIO, PAINTED METAL OR COVERED WITH LEATHER
- STAINLESS STEEL TOP

NOTE

- GLASS TOP AVAILABLE IN: SMOKED OR WHITE (RAL 9003)
- CERAMIC TOP AVAILABLE ON UP-CHARGE IN: TERRA, ANTRACITE OR OSSIDO BRUNO COLOR (CERAMIC TOP NOT AVAILABLE FOR T07)

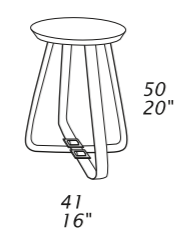
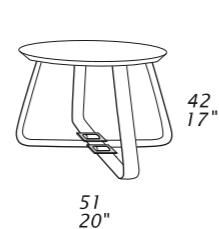
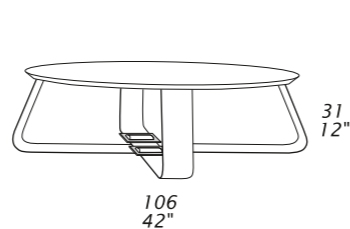
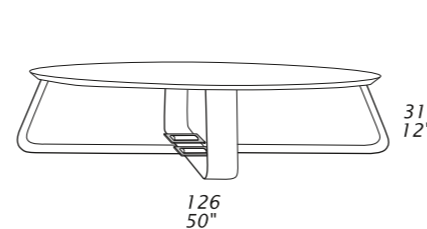
T04
top Ø 40 - 16"T05
top Ø 50 - 20"T06
top Ø 100 - 39"T07
top Ø 120 - 47"

STANDARD FEATURES

- HARD WOOD FRAME AND POLYURETHANE COVERED WITH LEATHER
- STAINLESS STEEL TOP

NOTE

- GLASS TOP AVAILABLE IN: SMOKED OR WHITE (RAL 9003)
- CERAMIC TOP AVAILABLE ON UP-CHARGE IN: TERRA, ANTRACITE OR OSSIDO BRUNO COLOR

T08

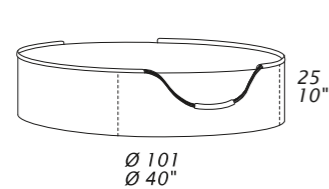

T09

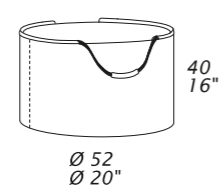

STANDARD FEATURES

- HARD WOOD FRAME AND POLYURETHANE COVERED WITH LEATHER
- STAINLESS STEEL TOP

T12

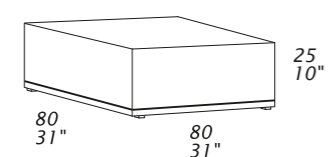

STANDARD FEATURES

- PAINTED METAL BASE
- STAINLESS STEEL TOP

NOTE

- BASE AVAILABLE IN: CHROME OR DARK CHROME-TITANIO
- GLASS TOP AVAILABLE IN: SMOKED OR WHITE (RAL 9003)
- CERAMIC TOP AVAILABLE ON UP-CHARGE IN: TERRA, ANTRACITE OR OSSIDO BRUNO COLOR

T14

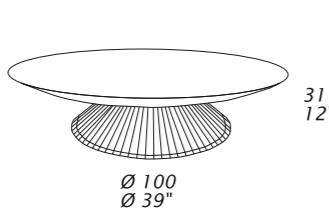

T15

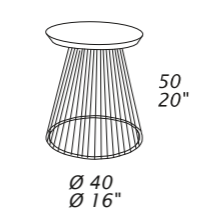

T16

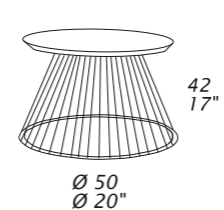

T40

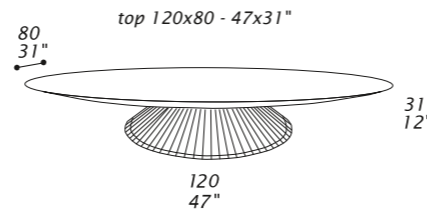

STANDARD FEATURES

- POLYURETHANE RESIN FRAME COVERED WITH LEATHER
- METAL INSERT AVAILABLE IN: CHROME, DARK CHROME-TITANIO OR PAINTED METAL
- STAINLESS STEEL TOP

NOTE

- GLASS TOP AVAILABLE IN: SMOKED OR WHITE (RAL 9003)

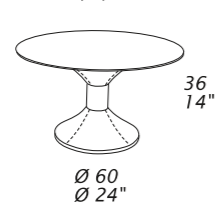
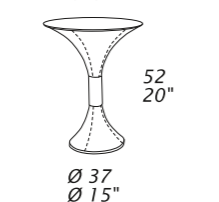
T17
clepsydraT18
clepsydra

Dimensions: the first figure shows sizes in centimeters, the second in inches.
Each piece is made by hand and has its own uniqueness. Measures may vary with a tolerance up to 3%.

Technical sheet

COFFEE TABLES

Design Giuseppe Viganò

STANDARD FEATURES

- BASE AVAILABLE IN: DARK CHROME-TITANIO OR PAINTED METAL
- STAINLESS STEEL TOP

NOTE

- GLASS TOP AVAILABLE IN: SMOKED OR WHITE (RAL 9003)
- CERAMIC TOP AVAILABLE ON UP-CHARGE IN: TERRA, ANTRACITE OR OSSIDO BRUNO COLOR

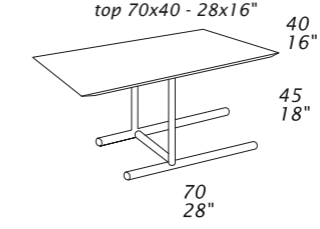
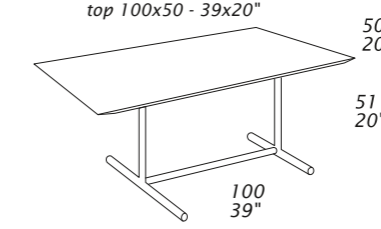
T19
ibisT20
ibis

STANDARD FEATURES

- BASE AVAILABLE IN: CHROME OR DARK CHROME-TITANIO COVERED WITH LEATHER
- STAINLESS STEEL TOP

T26

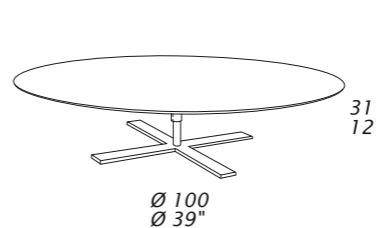

T27

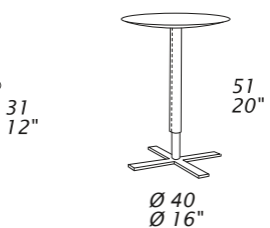

T28

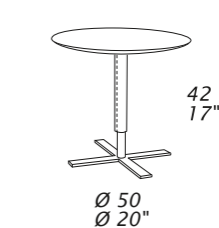

STANDARD FEATURES

- WOOD LEGS FINISH: NOCE CANALETTO OR FRASSINO
- LEATHER TOP WITH GROS GRAIN OR LEATHER PIPING

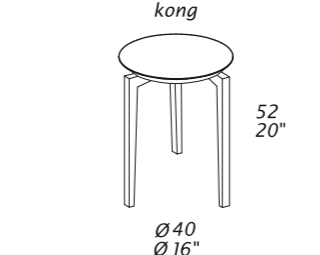
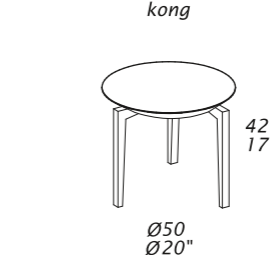
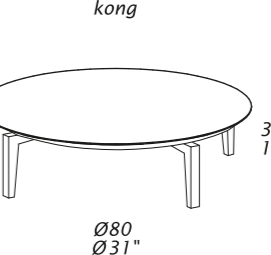
T29
kongT30
kongT31
kong

WOOD LEGS FINISH

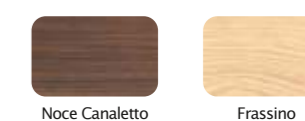

STANDARD FEATURES

- BASE AVAILABLE IN: CHROME, DARK CHROME-TITANIO, PAINTED METAL OR COVERED WITH LEATHER
- BUCKLE AVAILABLE IN: CHROME, DARK CHROME-TITANIO, PAINTED METAL OR COVERED WITH LEATHER
- STAINLESS STEEL TOP

NOTE

- GLASS TOP AVAILABLE IN: SMOKED OR WHITE (RAL 9003)
- CERAMIC TOP AVAILABLE ON UP-CHARGE IN: TERRA, ANTRACITE OR OSSIDO BRUNO COLOR

T120B

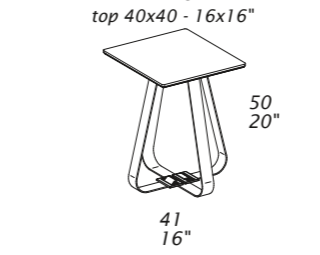

T121B

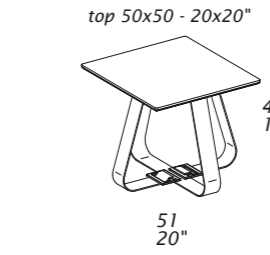

T122B

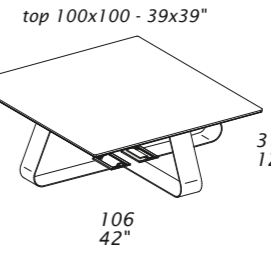

T123B

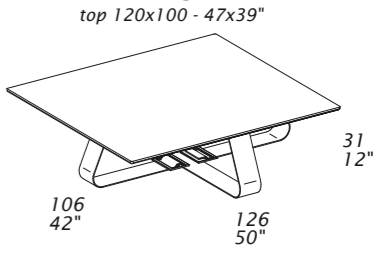

STANDARD FEATURES

- A: DARK CHROME-TITANIO OR PAINTED BASE
- B: CHROME, DARK CHROME-TITANIO OR PAINTED SUPPORTS
- GLASS TOP AVAILABLE IN: SMOKED OR WHITE (RAL 9003)

NOTE

- CERAMIC TOP AVAILABLE ON UP-CHARGE IN: TERRA, ANTRACITE OR OSSIDO BRUNO COLOR

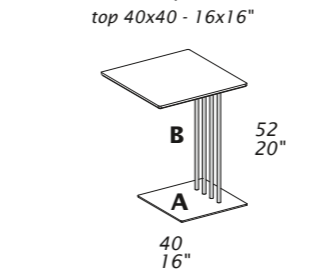
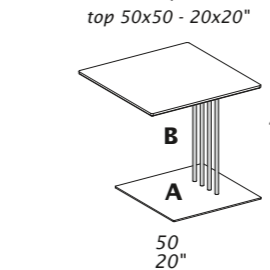
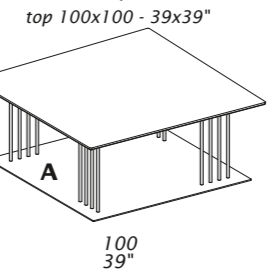
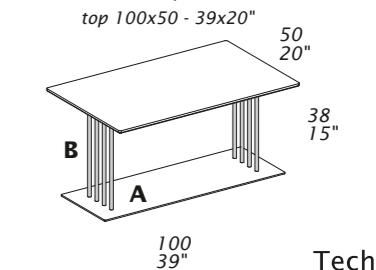
T125B
stripesT126B
stripesT127B
stripesT128B
stripes

Technical sheet

BAGS

Design Giuseppe Viganò

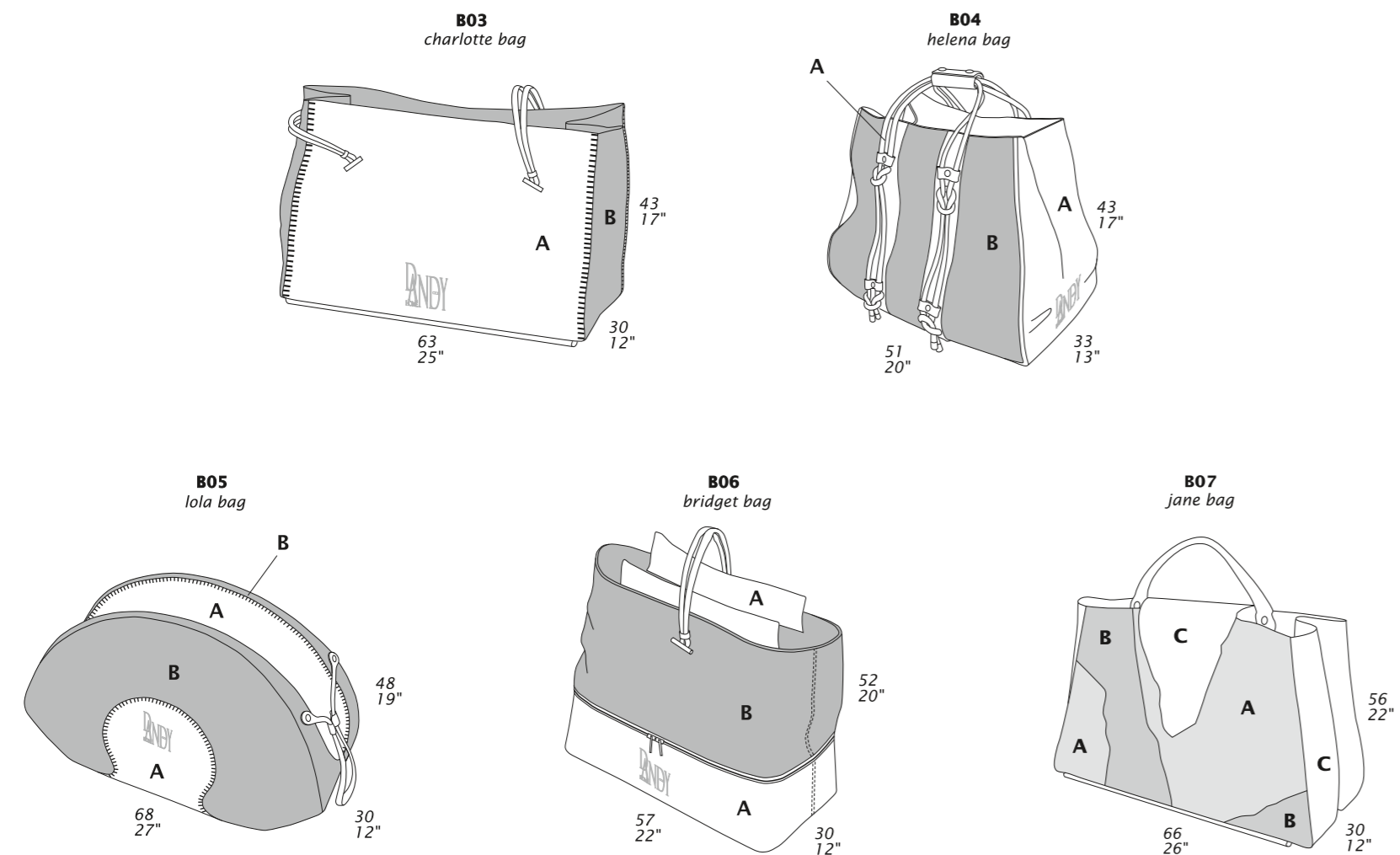

Dimensions: the first figure shows sizes in centimeters, the second in inches.
Each piece is made by hand and has its own uniqueness. Measures may vary with a tolerance up to 3%.
Dandy's Newspapers Bag, coordinated in the same cover and style to the sofa.

Technical sheet

BIG BAG

Design Giuseppe Viganò

STANDARD FEATURES
- HARD WOOD FRAME
- PADDING IN POLYURETHANE

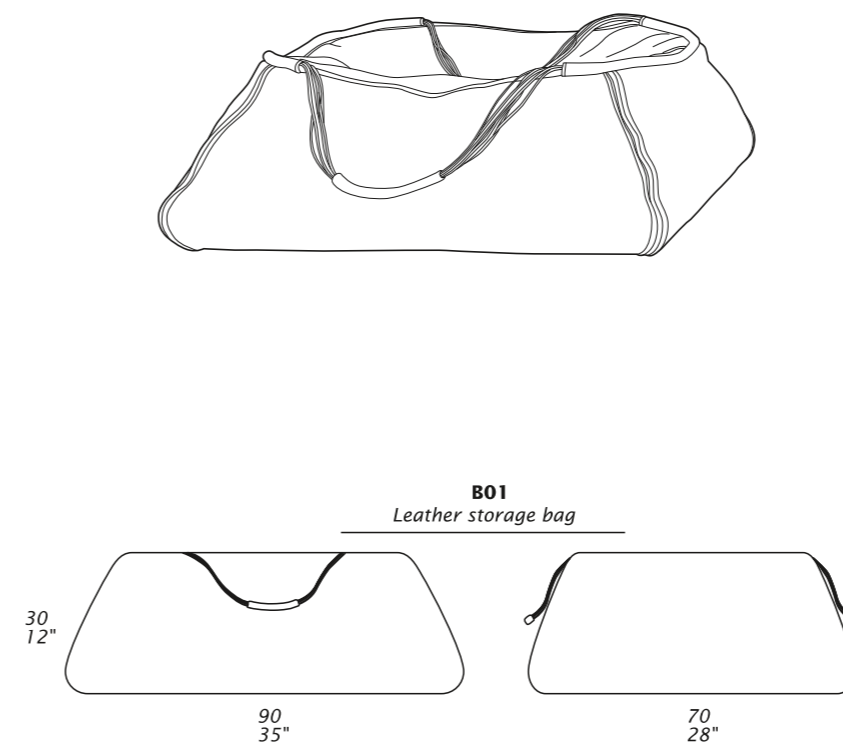

Dimensions: the first figure shows sizes in centimeters, the second in inches.
Each piece is made by hand and has its own uniqueness. Measures may vary with a tolerance up to 3%.

Technical sheet

SMART STOOLS

Design Giuseppe Viganò

- TOP AVAILABLE ON UP-CHARGE IN:
SMOKED OR WHITE (RAL 9003) GLASS
STEEL
CERAMIC TERRA, ANTRACITE OR OSSIDO BRUNO COLOR

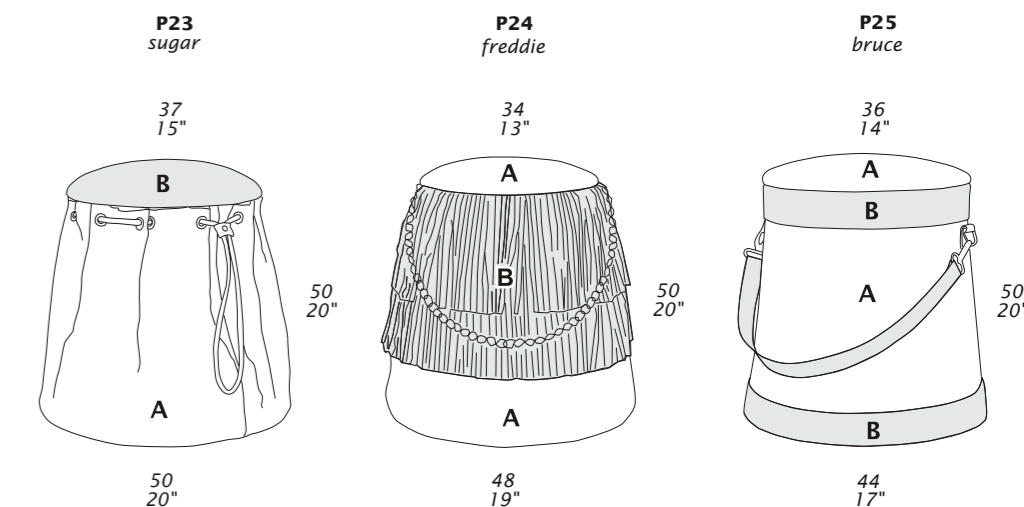

Dimensions: the first figure shows sizes in centimeters, the second in inches.
Smart stools, pouf and newspapers Bag, coordinated in the same cover and style to the sofa.

Technical sheet

ROYAL PILLOWS

Design Giuseppe Viganò

STANDARD FEATURES

- PILLOWS WITH FEATHER FILLING

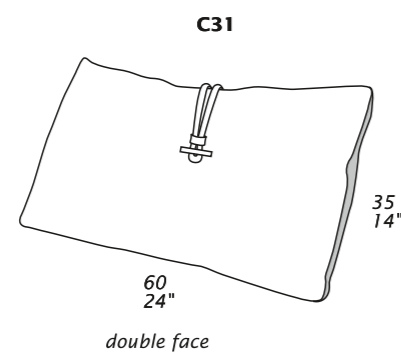
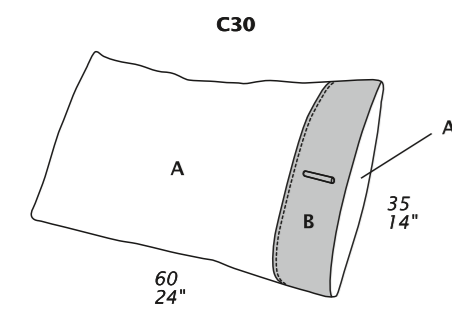
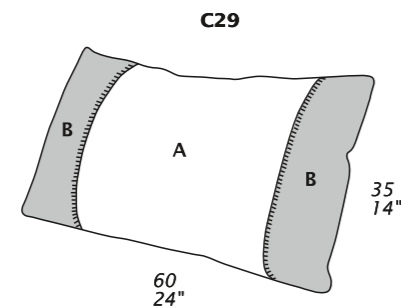
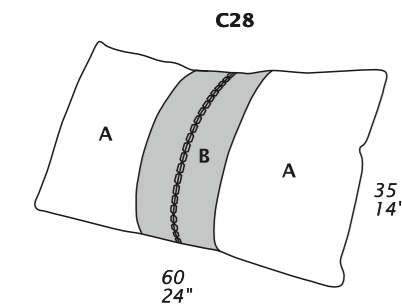

Dimensions: the first figure shows sizes in centimeters, the second in inches.

Each piece is made by hand and has its own uniqueness. Measures may vary with a tolerance up to 3%.

Technical sheet

PILLOWS

Design Giuseppe Viganò

STANDARD FEATURES

- PILLOWS WITH FEATHER FILLING
- HEADREST WITH POLYURETHANE FILLING

NOTE

- AVAILABLE WITH ANY STITCHING OF OUR COLLECTION

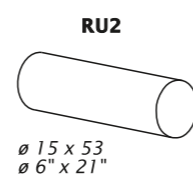
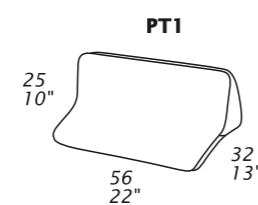
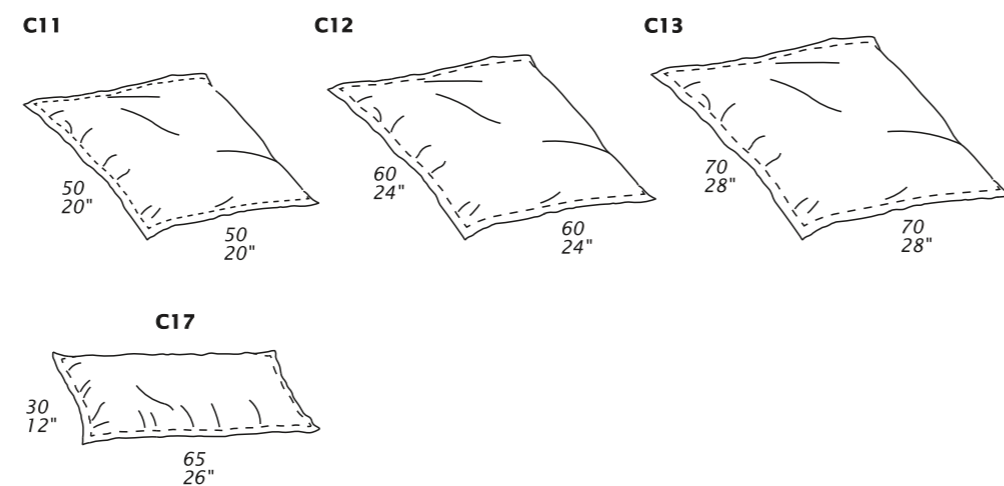

Dimensions: the first figure shows sizes in centimeters, the second in inches.

Each piece is made by hand and has its own uniqueness. Measures may vary with a tolerance up to 3%.

Technical sheet

OTTOMANS

Design Giuseppe Viganò

STANDARD FEATURES

- HARD WOOD FRAME
- PADDING IN POLYURETHANE

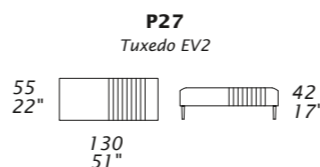
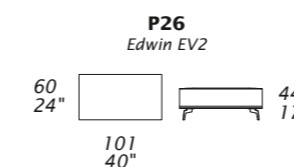
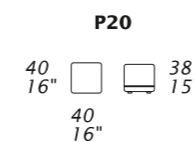
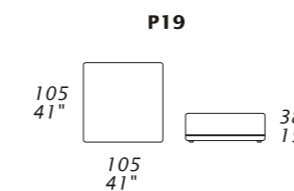
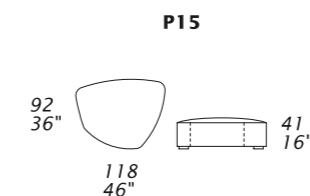
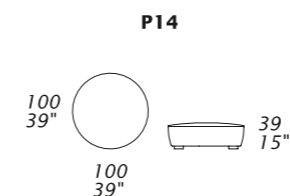
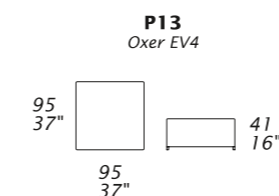
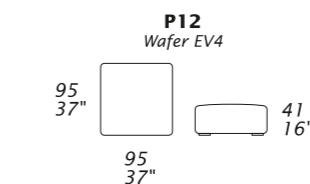
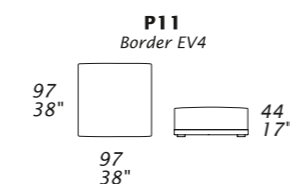
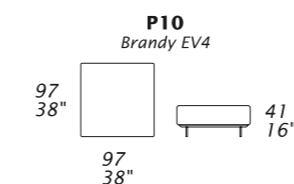

Dimensions: the first figure shows sizes in centimeters, the second in inches.

Each piece is made by hand and has its own uniqueness. Measures may vary with a tolerance up to 3%.

Technical sheet

BOULEVARD

Design Giuseppe Viganò

STANDARD FEATURES

- WOOD PANELS COVERED WITH LEATHER
- CHROME METAL SUPPORT
- LEATHER STRINGS
- SHELVES IN SMOKED GLASS OR EXTRA CLEAR GLASS

NOTE

- CUSTOMER CAN CHOOSE CONFIGURATIONS OF PANELS & SHELVES

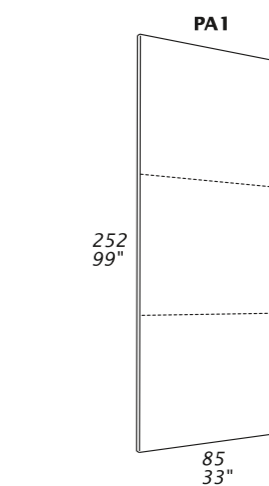
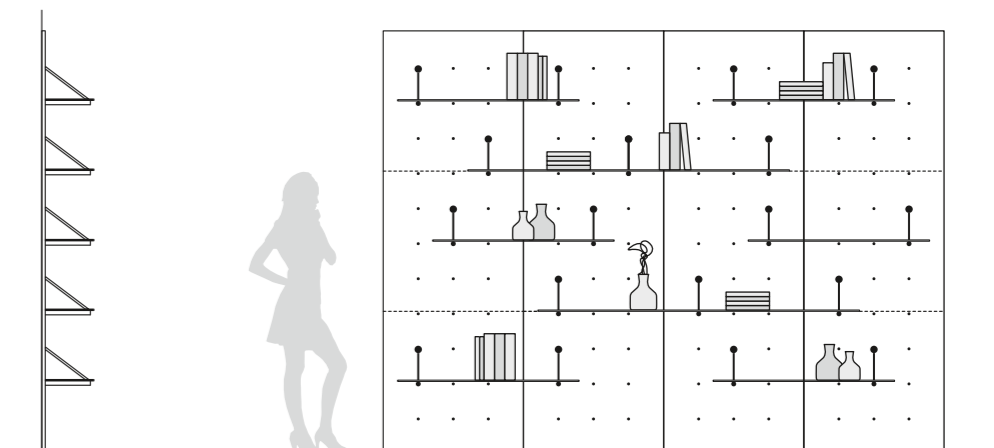

GLASS SHELVES (AVAILABLE IN DIFFERENT SIZES)

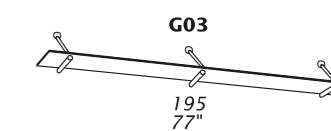
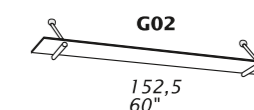
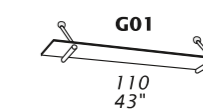

Dimensions: the first figure shows sizes in centimeters, the second in inches.

Each piece is made by hand and has its own uniqueness. Measures may vary with a tolerance up to 3%.

Technical sheet

NIGHT STANDS

Design Giuseppe Viganò

K09

STANDARD FEATURES

- HARD WOOD FRAME COVERED WITH LEATHER
- TOP AVAILABLE IN: SMOKED GLASS, WHITE (RAL 9003) GLASS OR STAINLESS STEEL

NOTE

- CERAMIC TOP AVAILABLE ON UP-CHARGE IN: TERRA, ANTRACITE OR OSSIDO BRUNO COLOR

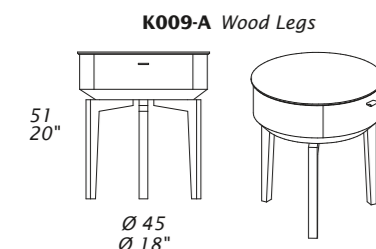

Ø 45
Ø 18"



Noce Canaletto



Frassino

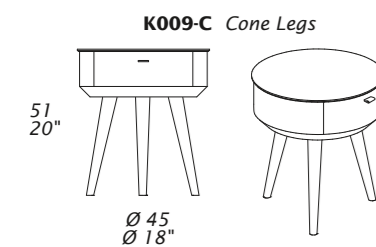

Ø 45
Ø 18"

DARK CHROME-TITANIO, CHROME OR PAINTED LEGS

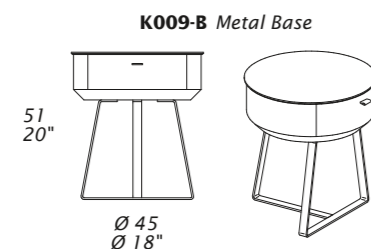

Ø 45
Ø 18"

DARK CHROME-TITANIO, CHROME OR PAINTED BASE

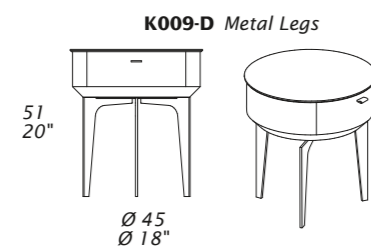

Ø 45
Ø 18"

DARK CHROME-TITANIO, CHROME OR PAINTED LEGS

K10

STANDARD FEATURES

- WOOD FRAME COVERED WITH LEATHER
- FRONT STAINLESS STEEL DRAWERS

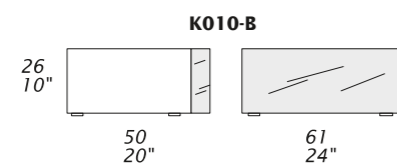
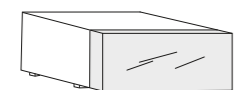

Dimensions: the first figure shows sizes in centimeters, the second in inches.
Each piece is made by hand and has its own uniqueness. Measures may vary with a tolerance up to 3%.

Technical sheet

MIRRORS

Design Giuseppe Viganò

STANDARD FEATURES

- HARD WOOD FRAME COVERED WITH LEATHER

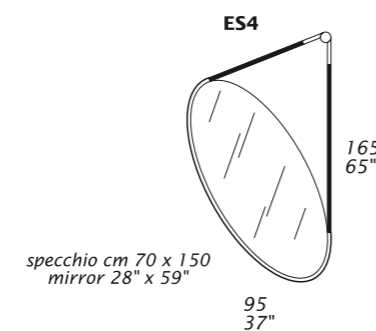

specchio cm 70 x 150
mirror 28" x 59"

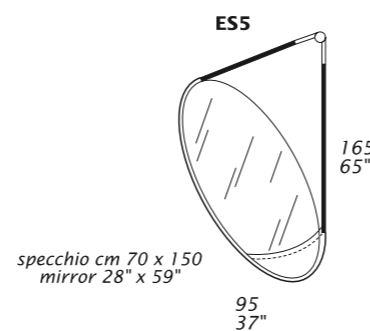

specchio cm 70 x 150
mirror 28" x 59"

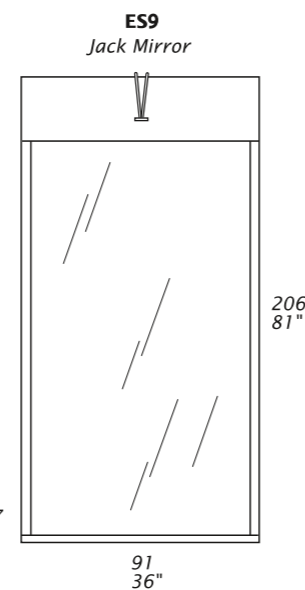

specchio cm 84 x 177
mirror 33" x 70"

Dimensions: the first figure shows sizes in centimeters, the second in inches.
Each piece is made by hand and has its own uniqueness. Measures may vary with a tolerance up to 3%.

Technical sheet

CUSTOMIZING

METAL LEGS FINISH

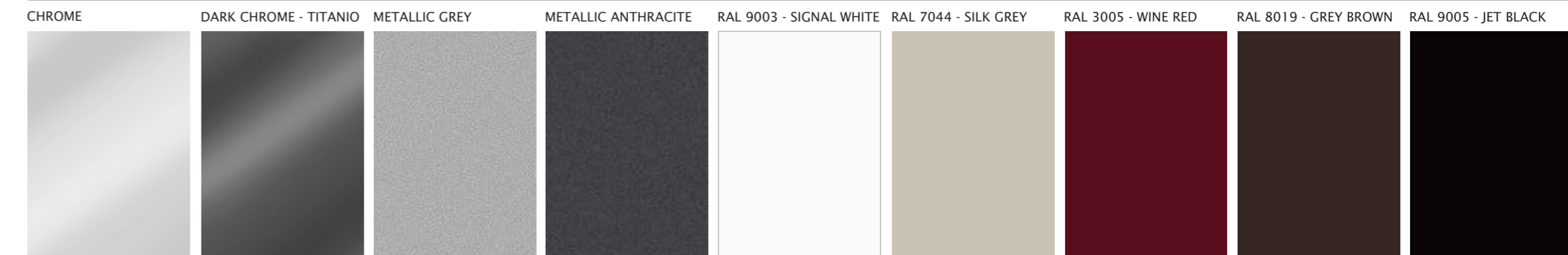

WOOD LEGS FINISH



CERAMIC TOP FINISH

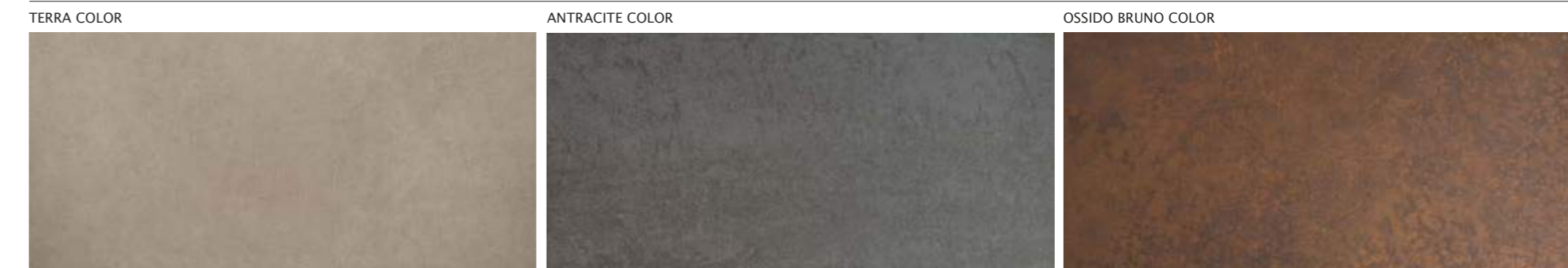

AD STUDIO VIGANÒ

PHOTO EOLO RADONI

PREPRESS MONOGRAMMA

PRINT GRAFICA GIOIA

D
ANDY
HOME

collection

100% hand made in Italy

by

GAMMA ARREDAMENTI INTERNATIONAL Spa

HEADQUARTERS

Via PITAGORA 3 - 47121 FORLÌ (FC) - Italia

PH. +39 0543 708311

FAX +39 0543 701795

e-mail: info@gammarr.it

U.S.A. GAMMA Inc.

520 SOUTH HAMILTON STREET - HIGH POINT, NC 27260

PH. +1 336 886 8060

FAX +1 336 886 8059

e-mail: infousa@gammarr.it

www.dandyhome.it
