

T'20 Objects, Stories  
cat. Sofas,  
Modular Systems

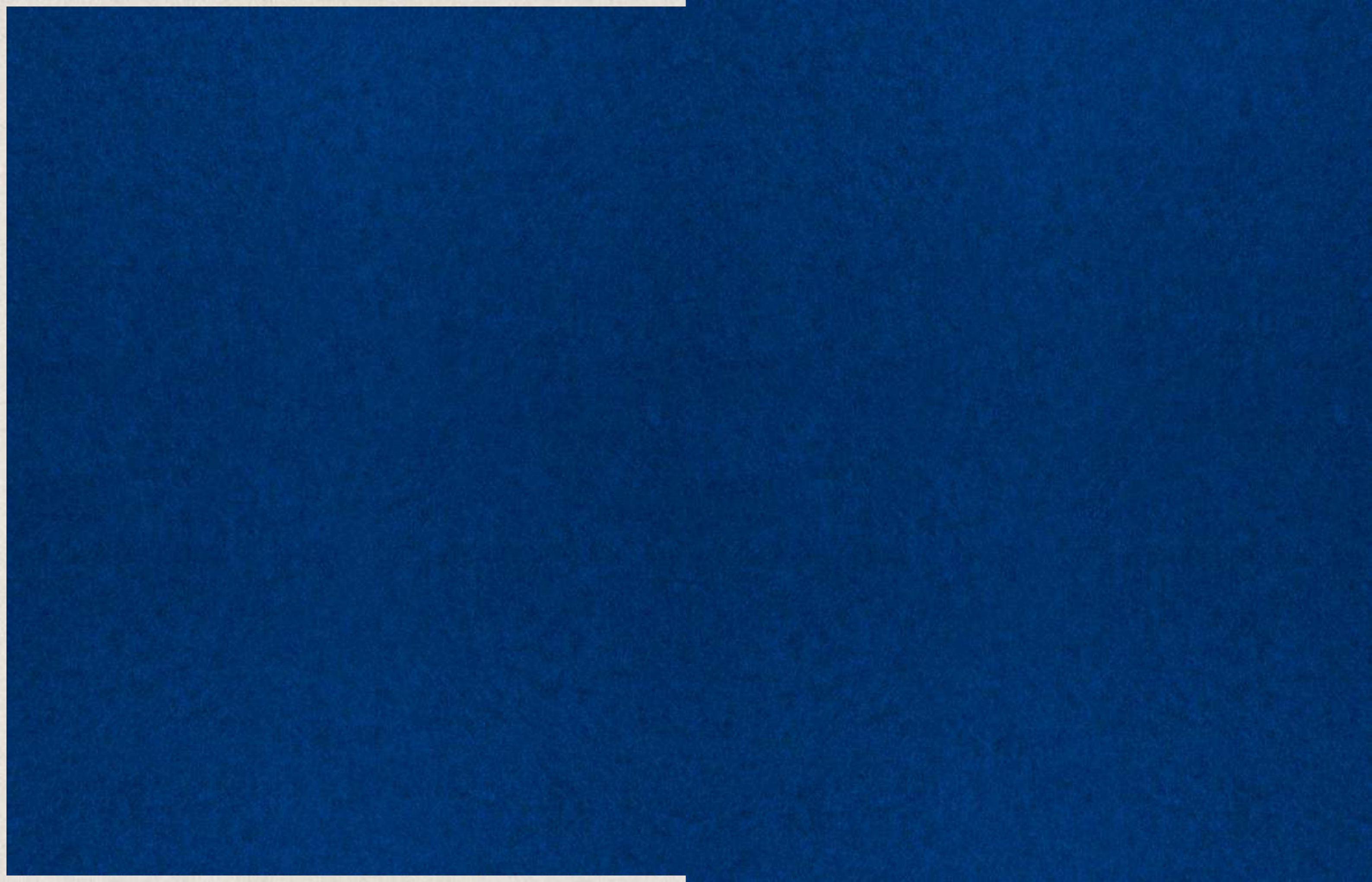

# Object, Stories

T'20 Vol. A

# Objects,

Immagini che raccontano momenti discreti, quasi intimi: le segrete stanze sono svelate, così come i loro abitanti. La grande casa Tacchini apre le sue porte, e mostra attimi rubati da una quotidianità che è fatta di cura e attenzione, per i materiali e gli strumenti: ma anche per gli uomini che li maneggiano con passione. Un luogo dove ognuno ha un ruolo e tutti sono parte di un'unica storia.

# Stories

Ci sono storie che si raccontano nell'immediatezza di un oggetto: i materiali addomesticati rivelano le mani che l'hanno plasmato, la forma suggerisce l'innovazione della tecnologia e la cultura dell'esperienza, mentre la funzione svela la poesia del *beau geste* progettuale. E la storia di un'azienda di design si racconta in ognuno dei capitoli che compone la sua produzione: come istantanee preziose di un lungo racconto, da scrivere ancora. Ogni progetto è il punto di tangenza tra esperienza e ricerca, passione e sentimento, arricchiti poi dal trascorrere del tempo nei luoghi dell'abitare, dove ognuno di noi interagisce con il proprio vissuto: in una staffetta continua tra presente e memoria.



Images that speak of discreet, almost intimate moments: the secret rooms are revealed, as are their inhabitants. The great Tacchini house opens its doors, exposing instants stolen from an everyday life built on care and attention for materials and tools, but also for the people that handle them with such dedication. A place where everyone has a role, and everyone is part of a unique story.

There are stories that are told through the immediacy of an object: domesticated materials speak of the hands that have shaped them, the shape suggests technological innovation and a culture of experience, while the function reveals the poetry of the design's *beau geste*. And the story of a design company is narrated in each of the chapters of its production, like precious snapshots of a long tale still to be written. Each project is the meeting point between experience and research, devotion and emotion, then enriched by passing time in the places where we live, where each of us interacts with our own experiences, in an ongoing relay between present and memory.



## Design Being

Tacchini è un luogo dove le mani sono il primo tra gli strumenti che hanno imparato a valorizzare, e che continuano a impiegare per riconoscere il pregio e valore dei materiali, per poi trasformarli, cucirli, e accostarli tra loro: procedendo secondo un ritmo di gesti sapienti e antichi, ripercorrendo, e migliorando ogni volta, la storia e la memoria. Fare le cose a mano significa stabilire un rapporto preciso tra oggetto e creatore, una trasmissanza, percepibile e visibile, di sensibilità e rispetto: e che si rivelerà anche a colui che possiederà quel manufatto. Una sorta di staffetta continua tra quanto le nostre dita riconoscono, nelle pieghe di una pelle o nella curva di un telaio, e le mani stesse che hanno reso possibile quelle forme.



## Objects, Stories



### Una storia di famiglia

Il design è italiano, il resto è produzione. E in Italia, le aziende di design portano il nome delle famiglie che ne hanno fondato il marchio. Come Tacchini, creata nel 1967 da Antonio: quando anche la produzione era quasi esclusivamente italiana, e sono stati scritti i brani più poetici e entusiasmanti della storia del design. Naturale che i figli diventino poi gli eredi, e ogni volta fondatori, secondo una logica di continuo aggiornamento e rielaborazione di un pensiero: ciò che viene realmente tramandato. Così come è naturale che chi frequenta questa famiglia ne diventi parte: collaboratori, consulenti, fornitori, dipendenti, maestranze, clienti. Ancora oggi, in questa famiglia, la forza dell'idea è al centro di ogni momento creativo, in un normale evolversi: dall'astrazione del pensiero alla tridimensionalità dell'oggetto, per poi diventare l'essenza dell'abitare. Questo procedere costante garantisce il legame con la contemporaneità, valorizzato poi dalla scelta di materiali di qualità e tecnologie

sempre aggiornate e sempre riferite a una tradizione da non perdere: evitando così la possibilità di confondere lo stile con le mode e il design con la semplice produzione di serie. Inevitabile che la storia di una famiglia si rifletta poi nei luoghi che essa abita: la sede di un'azienda è lo specchio delle persone che ci lavorano e della filosofia a cui esse si ispirano. La casa di Tacchini è un'architettura mossa su due livelli, incrocio di materiali e spazi che si fondono in un unico luogo di pensiero e sintesi dello stesso. Sullo sfondo, la Brianza, tra Como e Milano, troppo verde e accecante in estate e troppo grigia e intimista in inverno: questi luoghi, così estremi, diventano lo sfondo di questa storia, autentica culla del design, dove gli uomini e le idee si fondono nella cultura del progetto. Ogni oggetto, ciascun arredo che provenga da questa casa, porta con sé l'imprinting del design italiano: capace di rendere luogo qualsiasi spazio, sia esso pubblico o privato, domestico o collettivo, e riempiendolo dell'esserci.

## Design Being



## Objects, Stories

At Tacchini, hands were the first tool they learnt to harness, and they continue to use them to discern the quality and value of the materials, before transforming them, sewing them and combining them together: following ancient, knowing rhythms, retracing and honing history and memory. Doing things by hand means establishing a precise relationship between the object and its creator, a perceptible, visible transmittance of sensitivity and respect: and all this will be palpable to the person who ultimately possesses the item in question. A kind of ongoing relay between what our fingers can detect, in the folds of a piece of leather or in the curve of a frame, and the actual hands that have made those shapes possible.

### A family history

The design is Italian, the rest is production. And in Italy, design companies bear the names of the families that founded the brands. Like Tacchini, created in 1967 by Antonio, when production, too, was almost entirely Italian, and the most poetic and soul-stirring passages in the story of design were written. Naturally in time the children become the heirs, and the new founders, in a rationale of continuous updating and redefinition of the underlying idea, and that is what is actually handed down. Equally naturally, those who frequent the family become a part of it: team members, consultants, suppliers, employees, workers and clients. Still today, in this family, the strength of the idea is central to every creative process, in a logical process of evolution, from the analysis of the idea to the three dimensions of the object, before ultimately becoming the essence of living. This ongoing process ensures a sense of connection with contemporary style, which is then further enhanced by the choice of quality materials and leading-edge technology, and always referencing an all-important tradition, so as to avoid the danger of confusing style with fleeting fashions and design with simple mass production. Inevitably, the story of a family is reflected in the places they inhabit: the headquarters of a company mirrors the people who work there and the philosophy to which they aspire. The Tacchini building features an architecture structured into two storeys, a fusion of materials and spaces that blend into a complete whole, expressing its ethos and essence. In the background, Brianza, between Como and Milan, too blindingly green in summer, too grey and inward-looking in winter; these places with their extremes form the backdrop to this story, the very birthplace of design, where people and ideas merge with the design culture. Each object, each piece of furniture created in this building carries within it the hallmark of Italian design: the ability to give any space a sense of place, be it public or private, domestic or communal, filling it with presence.

Bei Tacchini sind die Hände das erste Werkzeug, das wir gelernt haben, uns nutzbar zu machen, und die weiterhin eingesetzt werden, um die Güte und den Wert von Materialien zu erkennen, sie zu verwandeln, zusammenzunähen und miteinander zu verbinden: das alles im Rhythmus weiser, althergebrachter Gesten, die Geschichte und Erinnerung durchlaufen und immer noch besser werden. Etwas mit den Händen zu schaffen, stellt eine klare

Beziehung zwischen dem Gegenstand und seinem Schöpfer her und vermittelt – wahrnehmbar und sichtbar – ein Gefühl der Sensibilität und Achtung: dieses Gefühl teilt sich auch dem Besitzer des Gegenstandes mit. Wie ein ständiger Staffellauf zwischen dem, was unsere Finger in den Falten des Leders oder der Biegung eines Gestells erkennen, und den Händen, die diese Formen ermöglichen haben.



**Eine Familiengeschichte**

Es gibt Geschichten, die von einem Gegenstand spontan erzählt werden: die gezähmten Materialien weisen auf die Hände hin, die sie geformt haben, die Form deutet den innovativen technischen Inhalt und die Kultur der Erfahrung an, während die Funktion die Poesie des kreativen Entwurfs erkennen lässt. Und die Geschichte einer Designerfirma erzählt sich in jedem Kapitel, aus dem sich ihre Produktion zusammensetzt: wie wunderbare Momentaufnahmen einer langen Erzählung, die weiter fortgesetzt wird. Bei jedem Entwurf treffen Erfahrung und Experiment, Leidenschaft und Gefühl zusammen, bereichert durch das Verstreichen der Zeit in der häuslichen Umgebung, die stets eine interaktive Beziehung zu unserem Leben herstellt: in einem kontinuierlichen Staffellauf von Vergangenheit und Erinnerung. Das Design ist italienisch, der Rest ist Produktion. In Italien tragen Designerfirmen den Namen der Familien, die sie gegründet haben. Wie Tacchini, der 1967 von Antonio ins Leben gerufene Betrieb: als auch die Produktion noch fast ausschließlich italienisch war und Poesie und Enthusiasmus die Geschichte von Design geprägt haben. Natürlich geht das Erbe auf die Söhne über, die das Bestehende immer wieder aktualisieren und neu bearbeiten und ihrerseits das begründen, was tatsächlich weitergegeben wird. Ebenso natürlich gehören bald alle zur Familie, die mit ihr zu tun haben: Mitarbeiter, Berater, Lieferanten, die ganze Belegschaft, Kunden. Auch heute noch steht in dieser Familie die Kraft der Ideen in einer normalen Entwicklung im Mittelpunkt jeder Kreativität: von der Abstraktion des Gedankens zur dreidimensionalen Größe eines Gegenstandes, der dann zum wesentlichen Bestandteil unserer Wohnwelt wird. Dieser kontinuierliche Prozess sorgt für den zeitgemäßen Charakter, der durch hochwertige Materialien und modernste Technik noch betont wird, ohne eine Tradition zu verlieren, die unverzichtbar ist: um nicht Stil mit Mode zu verwechseln und Design mit einer einfachen Serienproduktion. Unvermeidbar, dass sich die Geschichte einer Familie auch in den von ihr bewohnten Orten widerspiegelt: der Sitz eines Unternehmens ist der Spiegel der dort arbeitenden Menschen und der Philosophie, von der sie sich leiten lassen. Das Haus von Tacchini ist eine lebendige Architektur auf zwei Ebenen, eine Kreuzung aus Materialien und Räumen, die zu einem einzigen Ort der Gedanken und ihrer Synthese verschmelzen. Im Hintergrund die Brianza, die Region zwischen Como und Mailand, zu grün und zu blendend im Sommer, zu grau und zu intim im Winter: diese Orte der Extreme werden zur Kulisse dieser Geschichte, authentische Wiege des Designs, wo Menschen und Ideen in der Kultur der Entwürfe verschmelzen. Jeder Gegenstand, jedes Möbel aus diesem Hause ist von Design imitalienischen Stil geprägt: damit jeder Raum, ob öffentlich oder privat, häuslich oder kollektiv, zu einem lebendigen Ort werden kann.



Tacchini est un endroit où les mains sont le premier des outils qu'ils ont appris à mettre en valeur et qu'ils continuent à utiliser pour reconnaître la qualité et la valeur des matériaux, pour ensuite les transformer, les coudre et les marier entre eux : procédant selon un rythme de gestes savants d'antan, en refaisant le parcours de l'histoire et de la mémoire tout en l'améliorant à chaque fois. Faire les

choses à la main signifie établir un rapport précis entre l'objet et son créateur, une transmission, perceptible et visible, de sensibilité et de respect, qui se révélera aussi à la personne qui possédera cet article fait main. Une sorte de relais continu entre ce que nos doigts reconnaissent, dans les plis d'une peau ou dans la courbe d'un châssis, et les mains qui ont rendu ces formes possibles.



**Une histoire de famille**

Il y a des histoires qui se racontent dans l'immediateté d'un objet : les matériaux apprivoisés révelent les mains qui les ont modelés, la forme suggère l'innovation de la technologie et la culture de l'expérience, tandis que la fonction dévoile la poésie et la beauté du geste conceptuel. Et l'histoire d'une entreprise de design se raconte dans chacun des chapitres qui composent sa production : comme des instantanés précieux d'un long récit qui reste à écrire. Chaque projet est le point de rencontre entre l'expérience et la recherche, la passion et le sentiment, enrichis par l'écoulement du temps dans les espaces intimes, où chacun de nous interagit avec son vécu, dans une alternance continue entre présent et mémoire. Le design est italien, le reste est production. Et en Italie, les éditeurs de design portent le nom des familles qui en ont créé la marque. Comme Tacchini, créée en 1967 par Antonio, quand la production aussi était exclusivement italienne, et qu'ont été écrites les pages les plus poétiques et enthousiasmantes de l'histoire du design. Il est naturel que les enfants en héritent et se transforment parfois eux-mêmes en fondateurs, suivant une logique de mise à jour et réélaboration perpétuelle d'une pensée : ce qui est réellement transmis. Tout comme il est naturel que ceux qui fréquentent cette famille en fassent partie : collaborateurs, consultants, fournisseurs, salariés, ouvriers, clients. Aujourd'hui encore,

dans cette famille, la force de l'idée est au cœur de chaque moment créatif, dans une évolution logique : de l'abstraction de la pensée à la tridimensionnalité de l'objet, pour devenir en suite l'essence de l'habitat. Cette progression constante garantit le lien avec le contemporain, valorisé par le choix de matériaux de qualité et de technologies sans cesse améliorées et ayant toujours à l'esprit la tradition à préserver, en évitant ainsi la possibilité de confondre le style avec les modes et le design avec la simple production en série. Il est inévitable que l'histoire d'une famille se reflète dans les lieux qu'elle habite. Le siège d'une entreprise est ainsi le miroir des personnes qui y travaillent et de la philosophie à laquelle elles s'inspirent. La maison de Tacchini est une architecture élaborée sur deux niveaux, croisement de matériaux et d'espaces qui se fondent en un lieu unique de pensée et en sont la synthèse. En décor de fond, la Brianza, entre Côme et Milan, trop verte et éblouissante en été et trop grise et intimiste en hiver: ces lieux, si extrêmes, deviennent le cadre de cette histoire, authentique berceau du design, où les hommes et les idées se fondent dans la culture du projet. Chaque objet, chaque meuble qui provient de cette maison, porte avec lui l'imprinting du design italien : capable de faire de chaque espace un lieu, qu'il s'agisse d'une structure publique ou privée, domestique ou collective, en le remplissant du seul fait d'y être.



## Sofas

098	Crystal	PearsonLloyd	Sofa, Armchair ↻ Vol. B	Contract
092	Dressed	Luca Nichetto	Sofa	Domestic, Contract
044	Face to Face	Gordon Guillaumier	Sofa	Domestic, Contract
118	Havana	Lievore Altherr Molina	Sofa, Sofa Bed	Domestic, Contract
010	Julep	Jonas Wagell	Sofa, Armchair, Ottoman, Chaise-longue	Domestic, Contract
104	Labanca	Lievore Altherr Molina	Sofa, Armchair	Contract
078	Lima	Claesson Koivisto Rune	Sofa, Armchair, Ottoman	Domestic, Contract
056	Montevideo	Claesson Koivisto Rune	Sofa, Armchair, Ottoman, Chair ↻ Vol. B	Domestic, Contract
050	Oliver	Gianfranco Frattini	Sofa	Domestic, Contract
084	Quadro	Pietro Arosio	Sofa, Armchair, Ottoman	Domestic, Contract
062	Quilt	PearsonLloyd	Sofa, Armchair, Ottoman	Domestic, Contract
036	Roma	Jonas Wagell	Sofa, Armchair	Domestic, Contract
070	Santiago	Claesson Koivisto Rune	Sofa, Armchair, Ottoman	Domestic, Contract
018	Sella	Carlo De Carli	Sofa, Armchair	Domestic, Contract
026	Sesann	Gianfranco Frattini	Sofa, Armchair ↻ Vol. B	Domestic, Contract
112	Sliding	Pietro Arosio	Sofa, Sofa Bed	Domestic, Contract

## Modular System

132	Chill-Out	Gordon Guillaumier	Modular System	Contract
140	Chill-Out High	Gordon Guillaumier	Modular System	Contract
148	Galleria	PearsonLloyd	Modular System	Contract
190	Intercity	Pietro Arosio	Modular System, Ottoman	Contract
124	Ischia	PearsonLloyd	Modular System, Screen	Contract
162	Polar	PearsonLloyd	Modular System, Armchair, Ottoman	Contract
170	Polar Perch	PearsonLloyd	Modular System	Contract
180	Stone High/Low	PearsonLloyd	Modular System	Contract

## Technical informations

## Sofas

201	Crystal
201	Dressed
201	Face to Face
202	Havana
202	Julep
202	Labanca
203	Lima
203	Montevideo
203	Oliver
204	Quadro
204	Quilt
205	Roma
205	Santiago
205	Sella
206	Sesann
206	Sliding

## Modular Systems

207	Chill-Out
207	Chill-Out High Back/Arms
208	Chill-Out High
209	Galleria
210	Intercity
212	Ischia
213	Polar
213	Polar Perch
213	Stone High/Low

# Object, Stories

# Vol. A, Catalogue

# Julep

Famiglia di imbottiti dalle forme morbide e avvolgenti, Julep è ispirata all'Avant-Garde anni Cinquanta, di cui recupera la semplicità e l'imponenza, ingentilite da un'allure contemporanea, romantica e femminile.

Informazioni → p.017



Protagonista della serie è il divano, dal cui segno rotondo e generoso si è via via sviluppata l'intera collezione – composta da poltrona, chaise-longue e pouf – in un gioco di proporzioni e volumi che ha dato vita, a poco a poco, a tutte le varianti. Completamente imbottite, le sedute hanno un aspetto pieno e abbondante, e tuttavia leggero, grazie alla base rientrante che le solleva invisibilmente da terra. Per il loro aspetto confortevole che invita all'intimità e al riposo, le sedute di Julep sono pensate per gli spazi domestici e perfette negli ambienti del contract.

Awards: 2018 Muuz International Awards,  
2018 Archiproducts Design Awards

Designer, Year:  
Jonas Wagell, 2019







Julep (Sofa)  
W 240 D 126 H 75 cm  
H seat 42 cm

Julep (Armchair)  
W 102,5 D 87,5 H 75 cm  
H seat 42 cm

Julep

Joaquim (Low Table)  
top T119 Elegant Brown Marble,  
base T27 Matt Black  
Chrome → Vol. B p.282

→ Tacchini Edizioni:  
Rituale (Rug) designed  
by Umberto Riva

Julep (Sofa)  
W 240 D 126 H 75 cm  
H seat 42 cm

Julep (Armchair)  
W 102,5 D 87,5 H 75 cm  
H seat 42 cm

Soap (Low Table), top T118  
Shiny Patagonia Marble,  
base T25 Matt Champagne  
Gold ⇨ Vol. B p.290



⇨ Tacchini Edizioni:  
Rituale (Rug) designed  
by Umberto Riva



Julep (Chaise-longue)  
W 174 D 137 H 75 cm  
H seat 42 cm

Soap (Low Table), top T31  
White Calacatta Marble,  
base T25 Matt Champagne  
Gold ⇨ Vol. B p.290

## Julep

En Soft, envelopping shapes characterize this family of upholstered pieces. Julep is influenced by the 1950s Avant-Garde movement, drawing upon its simplicity and grandeur, refined by a contemporary, romantic, feminine allure. Star of the series is the sofa, whose generous rounded lines provided evolutionary DNA for the entire collection – including an armchair, a chaise-longue and an ottoman – in an interplay of proportions and shapes that gave rise, little by little, to all the other versions. Fully upholstered, the seats look ample and full, yet convey a sense of lightness, thanks to the recessed base that invisibly lifts them off the floor. Designed for home decor, their inviting appeal encourages cozy comfort and relaxation, making the Julep seating options also ideally suited to contract venues.

De Julep ist eine Familie von Polstermöbeln in weichen, anschmiegsamen Formen, einfach und wuchtig nach dem Muster der Avantgarde der 1950er Jahre, aber verfeinert durch ein zeitgenössisches, romantisch-weibliches Flair. Im Blickpunkt der Linie das Sofa: Aus seinen runden, großzügigen Formen hat sich die ganze Kollektion – Lehnssessel, Chaiselongue und Hocker – entwickelt, die im Spiel mit Proportionen und Volumen allmählich alle Varianten entstehen ließ. Die komplett gepolsterten Sitzmöbel sind voll und üppig in der Optik, aber dank der zurückspringenden Basis dennoch leicht und wie über dem Boden schwebend. Sitzmöbel Julep, mit dem komfortablen Aussehen eine Einladung zu vertraulichen Gesprächen und zur Entspannung, sind für das häusliche Ambiente bestimmt, aber passen ebenso perfekt in den Objektbereich.

Fr Famille de sièges rembourrés aux formes douces et enveloppantes, Julep s'inspire de l'avant-garde des années cinquante, dont elle récupère la simplicité et les volumes imposants tempérés par une allure contemporaine, romantique et féminine. Le protagoniste de la série est le canapé. À partir de son signe rond et généreux s'est peu à peu développée toute la collection – composée de fauteuil, chaise-longue et pouf – dans un jeu de proportions et de volumes qui a donné vie à toutes les variantes. Complètement rembourrés, les sièges ont un aspect plein et abondant, et toutefois léger, grâce à la base en retrait qui les soulève invisiblement du sol. Avec leur aspect confortable qui invite à l'intimité et au repos, les éléments de la série Julep sont pensés pour les intérieurs domestiques et parfaits dans les espaces collectifs.



Jonas Wagell

Jonas Wagell is an architect and designer from Stockholm. Born in 1973, he trained as graphic artist and then specialised as an interior designer in Stockholm and New York, where he attended the Parsons School of Design. In 2008 he founded the JWDA firm which handles architecture, product design and brand management projects. Wagell is fond of creating functional items with features of simplicity and intelligence, objects which can be used and understood easily by those who choose them.

Other products by Jonas Wagell:  
Roma ⇨ p.036

### Technical informations



Sofa ⇨ p.202



Armchair ⇨ p.202



Ottoman ⇨ p.202



Chaise-longue ⇨ p.202

Domestic, Contract

Sofa, Armchair

# Sella

Testimone del concetto di “spazio primario” della filosofia di De Carli, ovvero dello “spazio di relazione”, principi che trovano conferma nella visione della funzione d’arredo e della progettualità di interni secondo Tacchini, Sella è ispirato all’omonima poltrona disegnata nel 1966 dal celebre architetto italiano.

Informazioni → p.025



Il divano si presenta come un arredo di grande eleganza, realizzato con materiali di assoluto pregio: legno di noce a vista, dettagli in elegante metallo cromato finitura nera lucido e cinghie di supporto dello schienale in raffinato cuoio. Le cuscinature sono in pium e i rivestimenti possono essere in pelle, tessuto o velluto. La sua linea morbida e generosa è estremamente raffinata ed è progettata per regalare un comfort straordinario, dedicato a un tempo lento, che riconcilia con se stessi e con gli altri, nella dimensione di uno spazio di relazione più intimo e privato.

**Designer, Year:**  
Carlo De Carli, (1966) 2019



Sella (Sofa), base T116  
Canaletto Walnut  
W 222 D 97 H 83 H seat 42 cm

→ Tacchini Edizioni:  
Narciso (Rug)  
designed by Umberto Riva



Sella (Sofa), base T116  
Canaletto Walnut  
W 222 D 97 H 83 H seat 42 cm

Joaquim (Low Table), top T119  
Elegant Brown Marble,  
base T27 Matt Black Chrome  
⇒ Vol. B p.282

Sella

Quartier (Ottoman)  
⇒ Vol. B p.176

⇒ Tacchini Edizioni: Narciso (Rug)  
designed by Umberto Riva, Bubble (Vase)  
designed by Alvino Bagni, Tarsia  
(Tray) designed by Maria Gabriella Zecca





Sella (Armchair), base T116  
Canaletto Walnut  
W 102 D 97 H 83 H seat 42 cm

↳ Tacchini Edizioni:  
Narciso (Rug)  
designed by Umberto Riva

## Sella

Design Classic ↳ Vol. B p.002  
Discover Tacchini  
process of re-editions

Sella illustrates the concept of "primary space" from De Carli's philosophy – that of a "relational space" –, a principle true to Tacchini's vision of the function of furniture and interior design.

En Sella is inspired by the armchair of the same name designed in 1966 by the famous Italian architect. The highly elegant sofa is made using the very finest of materials: exposed walnut, elegant metal chromed details finish shiny black and belts for the support of the backrest in refined natural leather. The cushions are filled with feathers, and the coverings could be in leather, fabric or velvet. Its soft, generous line offers the utmost refinement, and is designed to guarantee extraordinary comfort, conducive to a slow tempo that will reconcile us with ourselves and others, in a more intimate and private spatial dimension.

De Sella inspiriert sich am gleichnamigen Sessel, den der berühmte italienische Architekt Carlo De Carli im Jahr 1966 entworfen hat. Das Sofa präsentiert sich mit großer Eleganz und ist aus hochwertigen Materialien gefertigt: Nussbaumholz in Sicht, elegante Details aus verchromtem Metall mit Oberfläche in Glanzschwarz und Riemen zur Unterstützung der Rückenlehne aus exklusivem Leder. Die Kissen mit Federfüllung sind mit Bezug aus Leder, Stoff oder Samt erhältlich. Das Sofa überzeugt mit seinen weichen und großzügigen Formen, die ihm eine extreme Eleganz verleihen, und bietet herausragenden Komfort für entspannte Momente alleine oder mit Freunden in einem intimen und privaten Ambiente.

Fr Sella s'inspire du fauteuil du même nom, dessiné en 1966 par le célèbre architecte italien Carlo De Carli. Caractérisé par une grande élégance, le canapé est réalisé avec des matériaux haut de gamme : bois de noyer apparent, détails en élégant métal chromé finition noir brillant et sangles soutenant le dossier en cuir raffiné. Les coussins sont en plume et les revêtements disponibles en cuir, tissu ou velours. Sa ligne douce et généreuse est extrêmement raffinée et conçue pour offrir un confort extraordinaire, dédié à un temps lent qui nous réconcilie avec nous-même et avec les autres, dans la dimension d'un espace relationnel plus intime et privé.



Carlo De Carli

Born in Milan, Carlo De Carli (1910-1999) graduated in 1934 in architecture from the Polytechnic University of Milan, worked for a year in the studio of Gio Ponti and took over the chair in interior architecture, furniture and decoration from him in 1962. Curator of the X and XI Milan Triennale, he was head of the architecture faculty from 1965 to 1968. Editor of the magazine Interni from 1967 to 1971. Design, research, teaching and promotion were the areas of action of his work, carried out with a broad communality of thinking and focused on people and the social and production context in which they operate. For De Carli the attitude behind the design of a house or of a chair does not change: "I love any form of architecture, provided it's researched, tested and essential (...) furniture too... I've designed a lot... it only seeks measure and not any effect... above all the measure that relates to the space of the home, in the sense of a tree" (Creatività, 1973). Through the publication *il mobile italiano* (1957-60) he promoted renewal of traditional furniture production centres and the coming together of international design culture, young architects and local artisans.

### Technical informations



Sofa ↳ p.205

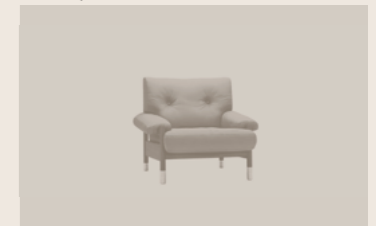

Armchair ↳ p.205

Domestic, Contract

Sofa, Armchair

# Sesann

Guardando l'opera di Gianfranco Frattini, il grande maestro del moderno design italiano, questo spirito metafisico traspare da ogni curva, da ogni sottile dettaglio e dalle combinazioni dei materiali che caratterizzano i suoi progetti.

Informazioni → p.035

Riedizione di uno storico progetto di Gianfranco Frattini, Sesann è una collezione di divani e poltrone che per le sue forme morbide e accoglienti suscita una sensazione di sensualità e calore. Merito della struttura in tubolare metallico che come un'architettura avvolge, contiene ed esalta l'imbottitura. Protagonista dello spazio per i volumi importanti e il design elegante ed elaborato, Sesann si può rivestire in pelle o tessuto per creare abbinamenti cromatici e materici di grande impatto tra imbottitura, struttura e piedini in legno di frassino.

**Designer, Year:**  
Gianfranco Frattini, (1970) 2015

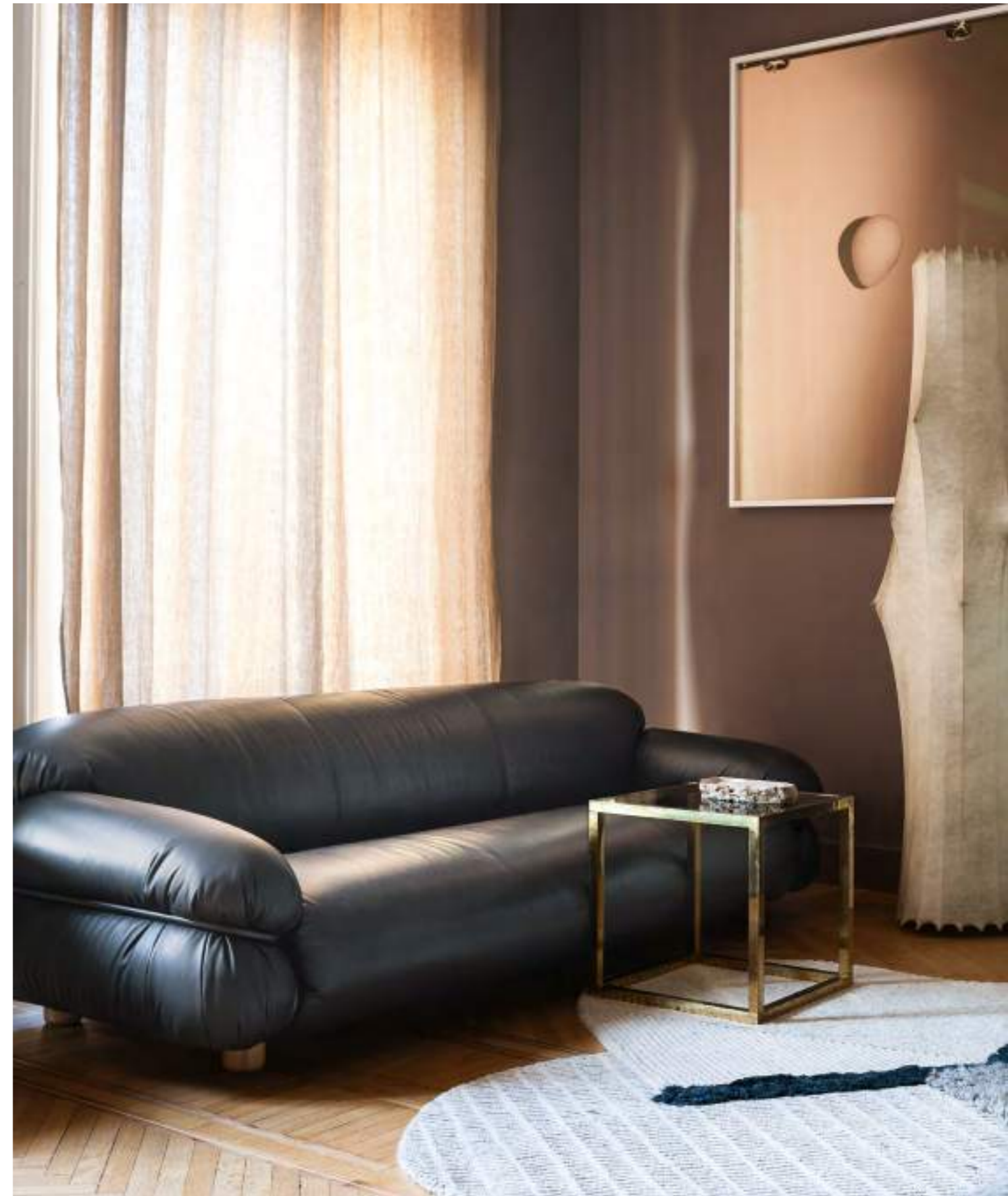

Sesann

Sesann (Sofa), structure T07 Black,  
feet T43 Dark Walnut  
W 240 D 94 H 67 H seat 38 cm





Sesann (Sofa), structure  
T28 Polished Black  
Chrome, feet T43 Dark Walnut  
W 240 D 94 H 67 H seat 38 cm

Cage (Low Table), top T32 Black Marquina  
Marble, base T27 Matt Black Chrome  
/top T41 Smoked Mirror, base T28 Polished  
Black Chrome ↪ Vol. B p.302

Sesann

Agnese (Armchair),  
base T43 Dark Walnut  
↪ Vol. B p.038

↪ Tacchini Edizioni:  
E63 (Lamp) designed by Umberto Riva,  
Tarsia (Tray) and Umbra (Rug)  
designed by Maria Gabriella Zecca

Sesann (Sofa), structure T28 Polished  
Black Chrome, feet T43 Dark Walnut  
W 240 D 94 H 67 H seat 38 cm



Soap (Low Table), top T74  
Sahara Noir Marble,  
base T03 Grey ↪ p.290

↪ Tacchini Edizioni:  
Umbra (Rug) designed by  
Maria Gabriella Zecca



Sesann (Sofa), structure T28  
Polished Black Chrome, feet T49 Grey  
W 240 D 94 H 67 H seat 38 cm

Shelter (Armchair),  
base T27 Matt Black Chrome  
⇒ Vol. B p.066

Sesann

Cage (Low Table), top T32 Black Marquina  
Marble, base T27 Matt Black Chrome  
/top T41 Smoked Mirror, base T28 Polished  
Black Chrome ⇒ Vol. B p.302



Sesann (Sofa), structure  
T11 Orange, feet T43 Dark Walnut  
W 240 D 94 H 67 H seat 38 cm

## Sesann

Design Classic ⇨ Vol. B p.002  
Discover Tacchini  
process of re-editions

Respecting the thought of Gianfranco Frattini, the new edition of Sesann keeps the spirit of the product intact. Characterized by a leather upholstery, Sesann owes its typical soft and enveloping form to the structure in pine plywood, covered with polyurethane foam and encircled with an architectural tubular steel (chromed or painted), with feet in ash wood. The particular configuration of Sesann – both formal and functional – constitutes the basis for a system of products characterized by the same structural elements, but declined in unique and fascinating objects. This approach of synthesis and reduction, proposed by Frattini, produced a formally elegant design, conceptually elaborated and, above all, unique.

En Looking at the work of Gianfranco Frattini, the great master of modern Italian design, we find that this metaphysical spirit shines through every rounded shape, every detail and combinations of materials that characterize his projects. A reissue of a historic design by Gianfranco Frattini, Sesann is a collection of sofas and armchairs with soft, cosy forms that evoke feelings of warmth and sensuality, thanks to the tubular metal frame, which acts as an architectural structure, enveloping, containing and accentuating the cushioning. Sesann commands its space with its bold volumes and elegant, sophisticated design. With a choice of leather or fabric coverings to create striking combinations of colours and textures between the cushions, frame and ash wood feet.

De Betrachtet man das Werk von Gianfranco Frattini, dem großen Meister des modernen italienischen Designs, dann ist dieser metaphysische Geist in jeder Rundung zu erkennen, in jedem noch so kleinen Detail und in den Materialkombinationen, die seine Projekte auszeichnen. Sesann, Neuauflage eines historischen Modells von Gianfranco Frattini, ist eine Kollektion aus Sofas und Fauteuils. Die weichen, anheimelnden Formen lassen ein sinnliches Gefühl der Wärme entstehen. Erreicht wird das durch eine Metallrohrstruktur, die wie eine Architektur die Polsterung umschließt, zusammenhält und optimal zur Geltung bringt. Mit den wuchtigen Volumen und dem elegant raffinierten Design beherrscht Sesann den Raum; Leder- oder Stoffbezug lassen sehr effektvolle, farbliche und stoffliche Kombinationen von Polsterung, Struktur und Füßen aus Eschenholz entstehen.

Fr En regardant le travail de Gianfranco Frattini, on voit l'esprit métaphysique du grand maître du design italien moderne briller à travers chaque courbe, chaque détail subtil et dans les combinaisons de matériaux qui caractérisent ses projets. Réédition d'un projet historique de Gianfranco Frattini, Sesann est une collection de canapés et de fauteuils dont les formes douces et accueillantes suscitent une sensation de sensualité et de chaleur. Tout le mérite en revient à la structure en tube métallique qui comme une architecture enveloppe, contient et met en valeur le rembourrage. Protagoniste de l'espace grâce à ses volumes importants et à son design élégant et raffiné, Sesann peut être revêtu de cuir ou de tissu pour créer des associations de couleurs et de matières d'un grand effet entre rembourrage, structure et pieds en bois de frêne.



Gianfranco Frattini

Gianfranco Frattini was born in Padua, Italy, on 15th May, 1926. He graduated in Architecture, at the Politecnico, Milan, in 1953. At the end of the 50's, he is one of the founders of ADI, Association for Industrial Design. Frattini opened his own studio in Milan, after working in the office of his teacher and mentor Gio Ponti. In few years, he became an industrial designer, well-known worldwide. Among his many successful projects, in 1956 designed the chair model 849, nominated for the "Compasso d'Oro" Prize. Now, this armchair, which takes shapes from the original design, is proposed by Tacchini with the name of "Agnese".

Other products by Gianfranco Frattini:  
Agnese ⇨ Vol. B p.038, Gio ⇨ Vol. B p.286,  
Giulia ⇨ Vol. B p.044, Lina ⇨ Vol. B p.032,  
Oliver ⇨ p.050, Sesann (Armchair) ⇨ Vol. B p.050

### Technical informations



Sofa ⇨ p.206



Armchair ⇨ p.206

# Roma

Quasi sospeso dal pavimento,  
con esilissime gambe che sorreggono  
la seduta ampia e avvolgente.

Informazioni → p.043



Roma (Sofa), base T25 Matt  
Champagne Gold  
W 234,5 D 121,4/84 H 73,5 cm  
H seat 38,5 cm

Soap (Low Table), top T31 White  
Calacatta Marble, base  
T25 Matt Champagne Gold,  
→ Vol. B p.290

**Designer, Year:**  
**Jonas Wagell, 2017**

Roma

Jonas Wagell immagina una famiglia di divani, ispirati dal segno morbido di una curva a emiciclo: questa piccola collezione si chiama Roma, evocando in modo sensibile, dalla poltrona alla chaise longue, passando per il divano, l'ambito classico a cui si possono ricondurre i segni stilistici del disegno. Un rimando al design degli anni '50, non di manierismo ma di attenta ispirazione: per un progetto nato già 'classico', appunto, anche nel nome.

Awards: 2017 Archiproducts Design Awards



Roma (Sofa), base T25  
Matt Champagne Gold  
W 234,5 D 121,4/84 H 73,5 cm  
H seat 38,5 cm

Roma (Armchair), base T25  
Matt Champagne Gold  
W 106,3 D 88,5 H 73,5 cm  
H seat 38,5 cm

Soap (Low Table), top T31  
White Calacatta Marble,  
base T25 Matt Champagne  
Gold ↪ Vol. B p.290

Roma



Roma (Sofa), base T25 Matt  
Champagne Gold  
W 233 D 92 H 73,5 cm  
H seat 38,5 cm

Roma (Armchair), base T25  
Matt Champagne Gold  
W 106,3 D 88,5 H 73,5 cm  
H seat 38,5 cm

Soap (Low Table), top T31  
White Calacatta Marble,  
base T25 Matt Champagne  
Gold ↪ Vol. B p.290



Roma (Sofa), base T25  
Matt Champagne Gold  
W 234,5 D 121,4/84 H 73,5 cm  
H seat 38,5 cm

## Roma

En Almost suspended above the floor, with the slenderest of legs upholding a large, cosy seat. Jonas Wagell imagines a family of sofas, inspired by the soft, curving form of a semicircle: this little collection, from armchair to sofa to chaise longue, is called Roma, a strong reference to the classical sphere in which its lines are rooted. With citations from fifties design, not of affectation, but of clear inspiration, this design is "classical" by nature, and not only in name.

De Der komfortable, körpergerechte Sitz ruht auf dünnen Beinen und scheint über dem Boden zu schweben. Jonas Wagell hat eine Linie von Sofas in den weichen Linien eines Halbrunds entworfen: die kleine Kollektion heißt Roma und alle, von Sessel und Chaiselongue bis Sofa, sind ein sehr einfühlsamer Bezug auf den klassischen Charakter dieser Stadt, der den Linien ihres Designs zugrunde liegt. Aufgegriffen wird das Design der Fünfzigerjahre, keine Nachahmung, sondern sensible Inspiration für einen geborenen „Klassiker“, wie bereits der Name sagt.

Fr Comme suspendue par rapport au sol avec des pieds très fins qui soutiennent l'assise ample et enveloppante. Jonas Wagell imagine une famille de canapés, s'inspirant de la douce sinuosité d'un hémicycle : cette petite collection s'appelle Roma, évoquant de manière sensible, du fauteuil à la chaise longue en passant par le canapé, le cadre classique auquel appartiennent les traits stylistiques du dessin. Un renvoi au design des années 1950, qui ne relève pas du maniérisme mais qui est le fruit d'une inspiration authentique pour un projet né déjà « classique », jusque dans le nom.



Jonas Wagell

Jonas Wagell is an architect and designer from Stockholm. Born in 1973, he trained as graphic artist and then specialised as an interior designer in Stockholm and New York, where he attended the Parsons School of Design. In 2008 he founded the JWDA firm which handles architecture, product design and brand management projects. Wagell is fond of creating functional items with features of simplicity and intelligence, objects which can be used and understood easily by those who choose them.

Other products by Jonas Wagell:  
Julep → p.010

### Technical informations



Sofa → p.205



Armchair → p.205



# Face to Face

“Siediti accanto a me. Voglio guardare il tuo viso mentre parliamo. Capire cosa pensi”. Gordon Guillaumier reinterpreta il divano e lo trasforma in uno spazio di relazione uno-a-uno.

Informazioni → p.049



Face to Face è un'originale reinterpretazione del divano come spazio di relazione uno-a-uno, con due schienali contrapposti e morbidi cuscini in piuma che invitano alla seduta vis à vis. Per il suo aspetto classico e leggero, Face to Face è pensato per essere protagonista a centro stanza, sia in uno spazio contract che nell'intimità di un salotto. Rivestito in tessuto o pelle, è cucito con punti incrocio a contrasto.

**Designer, Year:**  
Gordon Guillaumier, 2017

Face to Face

Face To Face (Sofa),  
base T03 Grey, yarn T79  
W 196 D 97 H 73,5 cm  
H seat 38 cm

Soap (Low Table),  
top T74 Sahara Noir  
Marble, base T03  
Grey → Vol. B p.290

→ Tacchini Edizioni:  
Linea (Rug) designed  
by Maria Gabriella Zecca



Face To Face (Sofa), base T27 Matt  
Black Chrome, yarn T82  
W 196 D 97 H 73,5 H seat 38 cm

Soap (Low Table),  
top T74 Sahara Noir  
Marble, base T03  
Grey ↗ Vol. B p.290

↗ Tacchini Edizioni:  
Umra (Rug) designed  
by Maria Gabriella Zecca

Face to Face



Face To Face (Sofa), base T27 Matt  
Black Chrome, yarn T82  
W 196 D 97 H 73,5 H seat 38 cm

Soap (Low Table),  
top T74 Sahara Noir  
Marble, base T03  
Grey ⇒ Vol. B p.290

⇒ Tacchini Edizioni:  
Umbrà (Rug) designed  
by Maria Gabriella Zecca

## Face to Face

En "Sit down next to me. I want to look at your face while we speak, to understand what you're thinking." Gordon Guillaumier reinterprets the sofa, transforming it into a space for one-on-one relations. Face to Face is an original reinterpretation of the sofa as a space for one-to-one relations, with two opposing backs and soft, feather cushions inviting people to sit vis-à-vis. With its light, classical style, Face to Face is conceived to take a central role and position, be it in contract spaces or in the intimacy of a living room. Covered in fabric or leather, it is sewn with contrasting cross-stitching.

De „Setz dich zu mir. Ich will dir ins Gesicht sehen, während wir uns unterhalten. Verstehen, was du denkst“. Gordon Guillaumier interpretiert das Sofa neu und verwandelt es in einen Raum der Beziehungen von Angesicht zu Angesicht. Face to Face ist eine originelle Neuinterpretation, die ein Sofa zum geselligen Ort für zwei Personen macht, mit zwei gegenüberliegenden Rückenlehnen und weichen Daunenkissen, die zur Unterhaltung vis à vis einladen. Klassisch und schwerelos im Aussehen, ist Face to Face ein zentraler Blickpunkt im Raum, im Objektbereich ebenso wie im privaten Salon. Bezogen mit Stoff oder Leder, mit farblich abgesetzten Kreuzstichnähten.

Fr « Assieds-toi à côté de moi. Je veux regarder ton visage quand nous parlons. Et comprendre ce que tu penses ». Gordon Guillaumier réinterprète le canapé et le transforme en un espace de relation individuelle. Face to Face est une réinterprétation originale du canapé comme espace de relation individuelle, avec deux dossiers opposés et des coussins moelleux garnis de plume qui invitent à la conversation en vis-à-vis. Avec son aspect classique et léger, Face to Face est pensé pour être protagoniste en milieu de pièce, dans un espace collectif comme dans l'intimité d'un salon. Revêtu de tissu ou de cuir, il est cousu avec des points de croix de couleur contrastante.



Gordon Guillaumier

Gordon Guillaumier was born in 1966, and was educated firstly in Malta, then in Switzerland, England and Italy. He graduated from IED in Milan (1988-91), before specializing in design at the Domus Academy, Milan (1992). In 1993 he began working with Baleri Associati, as well as collaborating with architect Rodolfo Dordoni. In 2002 he set up his own design studio in Milan, principally working on product design, but also for design consultancy projects. In 2006 he lectured in industrial design at Milan's Politecnico university.

Other products by Gordon Guillaumier:  
Cage ⇒ Vol. B p.302, Chill-Out ⇒ p.132, Chill-Out  
High ⇒ p.140, Coot ⇒ Vol. B p.308, Ledge ⇒ Vol. B p.316,  
Soap ⇒ Vol. B p.290, Spindle ⇒ Vol. B p.274

### Technical informations



Sofa ⇒ p.201

# Oliver

Riedizione dello storico modello 872 disegnato da Gianfranco Frattini nel 1957, il successo senza tempo del divano Oliver testimonia l'inscindibile accostamento progettuale di linea e materia nel lavoro del celebre designer italiano.

Informazioni → p.055

**Designer, Year:**  
Gianfranco Frattini, (1957) 2017

La leggerezza della solida struttura in acciaio verniciato o cromato sostiene seduta e schienale imbottiti, realizzati nella raffinata lavorazione artigianale a capitonné e disponibili in pelle o tessuto. I piedini a contrasto in essenza di frassino tinto sottolineano la cura del dettaglio costruttivo ed estetico, caratteristica di Frattini. Modello iconico del design contemporaneo made in Italy, Oliver coniuga il rigore dell'eleganza essenziale al comfort discreto di una costruzione impeccabile.







Oliver (Sofa), structure T02 White  
W 190 D 83,5 H 77 H seat 40 cm

## Oliver

Design Classic ⇨ Vol. B p.002  
Discover Tacchini  
process of re-editions

En A re-edition of the legendary Model 872, designed by Gianfranco Frattini in 1957, the Oliver sofa embodies the inseparable fusion of form and material in the renowned Italian designer's aesthetic concept. The visual lightness of the solid structure in powder coated or chrome steel artfully balances the sophisticated artisan craftsmanship in the hand-tufted seat and backrest, upholstered in leather or fabric. The wood feet, crafted in stained ash, emphasize the constructive and aesthetic attention to detail characteristic of Frattini's work. An iconic example of contemporary Italian design, Oliver blends the simplicity of uncluttered elegance and unpretentious comfort, flawlessly constructed.

De Das Sofa Oliver ist eine Neuauflage des ikonischen Modells 872, das Gianfranco Frattini 1957 entworfen hat, und sein zeitloser Erfolg bezeugt die untrennbare Verbindung von Linien und Materie, durch die sich die Arbeit des berühmten italienischen Designers auszeichnet. Das solide Gestell aus lackiertem oder verchromtem Stahl besticht mit seiner Leichtigkeit und stützt die gepolsterte Sitzfläche und Rückenlehne, ausgeführt in hochwertiger handwerklicher Fertigung mit Knopfleftung und erhältlich in Leder oder Stoff. Die Füße aus gebeiztem Eschenholz bilden einen eleganten Kontrast und betonen die sorgfältige Ausführung und das raffinierte Design, die für Frattini typisch sind. Oliver ist ein ikonisches Modell des zeitgenössischen Designs Made in Italy und verbindet die Strenge der minimalistischen Eleganz mit dem angenehmen Komfort einer Ausführung auf höchstem Niveau.

Fr Le succès intemporel du canapé Oliver – une réédition du modèle historique 872 conçu par Gianfranco Frattini en 1957 – témoigne de la combinaison conceptuelle indissociable de la ligne et de la matière dans l'œuvre du célèbre designer italien. La légèreté de la solide structure en acier peint ou chromé soutient l'assise et le dossier capitonnés, de facture artisanale raffinée et disponibles en cuir ou en tissu. Les pieds contrastants en bois de frêne teinté soulignent l'attention portée aux détails de construction et esthétiques qui caractérise Frattini. Oliver est un modèle iconique du design contemporain made in Italy qui allie la rigueur de l'élégance minimaliste au confort discret d'une construction impeccable.

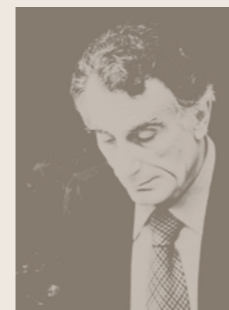

Gianfranco Frattini

Gianfranco Frattini was born in Padua, Italy, on 15th May, 1926. He graduated in Architecture, at the Politecnico, Milan, in 1953. At the end of the 50's, he is one of the founders of ADI, Association for Industrial Design. Frattini opened his own studio in Milan, after working in the office of his teacher and mentor Gio Ponti. In few years, he became an industrial designer, well-known worldwide. Among his many successful projects, in 1956 designed the chair model 849, nominated for the "Compasso d'Oro" Prize. Now, this armchair, which takes shapes from the original design, is proposed by Tacchini with the name of "Agnese".

Other products by Gianfranco Frattini:  
Agnese ⇨ Vol. B p.038, Gio ⇨ Vol. B p.286,  
Giulia ⇨ Vol. B p.044, Lina ⇨ Vol. B p.032,  
Sesann ⇨ p.026, Sesann (Armchair) ⇨ Vol. B p.050

### Technical informations



Sofa ⇨ p.203

Domestic, Contract

Sofa, Armchair, Ottoman, Chair

# Montevideo

Linee e proporzioni studiate con cura, per offrire un comfort totale: questo è il principio ispiratore del divano Montevideo.

Informazioni → p.061



Braccioli e schienale disegnano un'unica forma morbida e accogliente, completata da cuscini in piuma che sostengono la zona lombare. Ergonomico ed elegante, il divano Montevideo è inoltre abbinabile ad una poltrona coordinata. Un volume soffice che accoglie piacevolmente il corpo, un cuscino con imbottitura in piuma da posizionare liberamente per un comfort ancora più personalizzato: è la poltrona Montevideo, una sintesi di estetica ed ergonomia per gli ambienti più diversi, da sola o in abbinamento al divano dal design coordinato.

Designer, Year:  
Claesson Koivisto Rune, 2008



Montevideo

Montevideo (Armchair),  
base T07 Black  
W 96 D 90 H 78 H seat 40 cm



Montevideo (Sofa),  
base T94 Bronze  
W 222 D 90 H 78 cm  
H seat 40 cm

Montevideo (Armchair),  
base T94 Bronze  
W 96 D 90 H 78 cm  
H seat 40 cm

Montevideo  
(Ottoman), base  
T94 Bronze  
W 93 D 71 H 40 cm

Soap (Low Table), top T118 Shiny  
Patagonia Marble, base T25  
Matt Champagne Gold → Vol. B p.290





## Montevideo

En Carefully designed shapes and sizes for all-round comfort: this is the guiding principle behind the Montevideo sofa. Armrests and backrest trace a soft and cozy outline, complete with feather cushions supporting your lower back. Ergonomic and elegant, the Montevideo sofa is also paired with a matching armchair. A soft, enveloping frame that warmly accommodates the body, a feather cushion to be arranged at will for a more customized comfort: this is the Montevideo armchair, the net result of aesthetic and ergonomic principles and designed for a variety of settings, either as stand-alone or combined with its matching sofa.

De Bestens durchdachte Linien und Proportionen um umfassenden Komfort bieten zu können: das ist das inspirierende Prinzip des Sofas Montevideo. Die Arm- und Rückenlehnen ergeben eine einzige gemütliche und behagliche Form, welche durch Federkissen ergänzt wird um den Rücken zu stützen. Ergonomisch und elegant ist das Sofa Montevideo desweiteren auch mit dem koordinierbaren Sessel kombinierbar. Ein gemütliches Volumen, welches auf angenehme Art und Weise den Körper umgibt, ein mit Federn gefülltes Kissen, welches so positioniert werden kann, dass es einen noch persönlicheren Komfort schafft: das ist der Sessel Montevideo, eine Synthese aus Ästhetik und Ergonomie, geschaffen für die verschiedensten Räumlichkeiten, allein oder auch in Kombination mit dem Sofa in koordiniertem Design.

Fr Des lignes et des proportions étudiées avec soin pour offrir un confort total : voici le principe qui a inspiré la création du canapé Montevideo. Les accoudoirs et le dossier dessinent une forme unique, souple et accueillante, complétée par des coussins en plume qui soutiennent la base du dos. Ergonomique et élégant, le canapé Montevideo peut être associé en outre à un fauteuil coordonné. Un volume moelleux qui accueille agréablement le corps, un coussin avec un rembourrage en plume, peut être positionné librement pour un confort encore plus personnalisé : voici le fauteuil Montevideo, une synthèse d'esthétique et d'ergonomie pour les milieux les plus divers, seul ou associé au canapé du design coordonné.



### Claesson Koivisto Rune

The Claesson Koivisto Rune studio was established in 1995 as a multidisciplinary architecture and design workshop, in line with the classic Scandinavian tradition, but with the aim of exploring new concepts, and pursuing the values of simplicity and innovation. The three Swedes have created architectural designs throughout the world and in every sector, from homes to restaurants, retail to executive buildings, as well as furniture ranges for numerous major international firms.

Other products by Claesson Koivisto Rune: Campo (Tacchini Edizioni), Doodle (Armchair, Chaise-longue) → Vol. B p.082, Doodle (Chair, Stool) → Vol. B p.228, Isola → Vol. B p.114, Kelly B → Vol. B p.296, Kelly C → Vol. B p.202, Kelly C Basic → Vol. B p.202, Kelly E → Vol. B p.072, Kelly H → Vol. B p.072, Kelly L+F → Vol. B p.072, Kelly O → Vol. B p.296, Kelly S → Vol. B p.072, Kelly T → Vol. B p.266, Kelly V → Vol. B p.210, Kelly W → Vol. B p.296, Lima → p.078, Misura S/M → Vol. B p.150, Montevideo (Chair) → Vol. B p.222, Pisa → Vol. B p.100, Quartier → Vol. B p.176, Santiago → Vol. A p.070, Spin → Vol. B p.182, Split → Vol. B p.260

### Technical informations



Sofa → p.203



Armchair → p.203



Ottoman → p.203

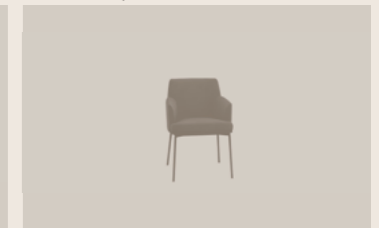

Chair → p.203

Montevideo (Sofa),  
base T07 Black  
W 222 D 90 H 78 H seat 40 cm

Montevideo (Armchair),  
base T07 Black  
W 96 D 90 H 78 H seat 40 cm

# Quilt

La semplicità complessa della sintesi di modernità e classicità. PearsonLloyd disegna Quilt dando forma alla creatività di un modello che va oltre stili e definizioni, perché in se stesso sembra raccoglierne armoniosamente molti.

Informazioni → p.069

Le linee semplici ma piene del sistema di divani e poltrone Quilt, con la morbida rotondità dei cuscini della profonda seduta e la particolare lavorazione verticale dell'imbottitura di schienale e braccioli, accolgono con un'eleganza dal sapore ricercato, che arreda perfettamente spazi domestici e ambienti contract internazionali. Il lineare basamento in acciaio dona un effetto sospeso all'arredo dal design pieno e compatto, con un risultato di inaspettata leggerezza. Il sistema è completato dall'omonimo pouf di forma quadrata.

Designer, Year:  
PearsonLloyd, 2007









Quilt (Sofa), base T03 Grey  
W 260 D 80 H 68 H seat 41 cm

## Quilt

En Modern meets classic in an alliance based on simplicity. Designed by PearsonLloyd, Quilt is the creative expression of a style that defies fashions and definitions because it appears to elegantly embrace many of them. The clean yet voluptuous lines of the Quilt sofa and armchair system, the rounded softness of the deep seat cushions and the special vertical stitching on the quilted backrest and armrests all lend an air of sophisticated elegance, perfect for home decor and international contract settings. Thanks to the sleek steel base, the pieces appear to float just above the floor. The rich yet compact design yields unexpected visual lightness. The square Quilt ottoman completes the system.

De Die komplexe Schlichtheit der Verschmelzung von Moderne und Klassik. Das Designstudio PearsonLloyd hat das Sofa Quilt entworfen und dabei der Kreativität eines Modells eine Form verliehen, die über Stil und Definitionen hinausgeht und viele verschiedene Elemente harmonisch in sich vereint. Die schlichten und gleichzeitig großzügigen Linien der Sofas und Sessel der Kollektion Quilt mit den charakteristischen abgerundeten Kissen der sehr tiefen Sitzfläche und der besonderen vertikalen Steppung bestechen mit ihrer Eleganz und ihrem geschmackvollen Design und machen Quilt perfekt für Wohnungen und für die internationale Objekteinrichtung. Mit ihrem linearen Gestell aus Stahl scheinen die kompakten und üppigen Polstermöbel über dem Boden zu schweben, wodurch der Eindruck einer unerwarteten Leichtigkeit entsteht. Ergänzt wird die Kollektion durch den gleichnamigen quadratischen Polsterhocker.

Fr La simplicité complexe de la synthèse de la modernité et du classicisme. En dessinant Quilt, PearsonLloyd a donné forme à la créativité d'un modèle qui va au-delà des styles et des définitions car il semble en englober harmonieusement un bon nombre. Les lignes simples mais pleines du système de canapés et de fauteuils Quilt, caractérisé par la douce rondeur des profonds coussins d'assise et par la facture originale du rembourrage vertical du dossier et des accoudoirs, sont accueillantes et leur élégance sophistiquée meuble à merveille les espaces domestiques et ceux du secteur contract international. Le piètement linéaire en acier donne un effet suspendu à ce meuble au design plein et compact qui résulte ainsi d'une légèreté inattendue. Le pouf carré du même nom vient compléter le système.



PearsonLloyd

PearsonLloyd is one of the leading names in contemporary British design, and this multidisciplinary studio works in a wide range of sectors: from furnishing to public spaces to brand development. Established by Luke Pearson and Tom Lloyd in 1997, the studio has received numerous acknowledgements and accolades in both Europe and the United States. The British design duo write regularly for major design magazines, as well as acting as "visiting lecturers" at the École Cantonale d'Art in Lausanne.

Other products by PearsonLloyd:  
Crystal ⇨ p.098, Crystal (Armchair) ⇨ Vol. B p.108,  
Eddy ⇨ Vol. B p.240, Fixie ⇨ Vol. B p.252,  
Galleria ⇨ p.148, Ischia ⇨ p.124, Nebula (Tacchini Edizioni), Polar ⇨ p.162, Polar Perch ⇨ p.170,  
Polar Table ⇨ Vol. B p.312, Stone High/Low ⇨ p.180

### Technical informations



Sofa ⇨ p.204



Armchair, Ottoman ⇨ p.204

# Santiago

Morbide e accoglienti, le sedute della collezione Santiago nascono da un abile gioco di proporzioni.

Informazioni → p.077



Morbide e accoglienti, le sedute della collezione Santiago nascono da un abile gioco di proporzioni. Piedini esili e di altezza ridotta sostengono i volumi rotondi e generosi della seduta e dello schienale, creando forme piene che anche visivamente invitano al comfort e al riposo. La collezione è composta da un divano e da una poltrona con poggiatesta, che vivono da soli o insieme, dentro ambienti dagli stili più diversi.

Awards: 2017 German Design Awards

Designer, Year:  
Claesson Koivisto Rune, 2016



Santiago (Armchair),  
base T03 Grey  
W 96 D 88 H 85 cm  
H seat 41 cm

Santiago (Ottoman),  
base T03 Grey  
W 93 D 71 H 40 cm



Santiago (Sofa),  
base T03 Grey  
W 164 D 88 H 85 cm  
H seat 41 cm

Santiago (Armchair),  
base T03 Grey  
W 96 D 88 H 85 cm  
H seat 41 cm

Soap (Low Table),  
top T74 Sahara Noir  
Marble, base T03  
Grey ↗ Vol. B p.290

Santiago

↗ Tacchini Edizioni:  
E63 (Lamp) designed by  
Umberto Riva



Santiago (Sofa),  
base T02 White  
W 164 D 88 H 85 cm  
H seat 41 cm

Santiago (Armchair),  
base T02 White  
W 96 D 88 H 85 cm  
H seat 41 cm

Santiago (Ottoman),  
base T02 White  
W 93 D 71 H 40 cm

## Santiago

↳ Tacchini Edizioni:  
Campo (Rug) designed by  
Claesson Koivisto Rune





Santiago (Sofa),  
base T02 White  
W 164 D 88 H 85 cm  
H seat 41 cm

↳ Tacchini Edizioni:  
Campo (Rug) designed by  
Claesson Koivisto Rune

## Santiago

En The soft and cosy seating of the Santiago collection is the fruit of the skilled use of proportions. Slim, short legs, support the generous, round volumes of the seat and back, to create full shapes that offer a visual invitation to find comfort and rest. The collection includes a sofa and an armchair with footrest, which can live alone or together, in settings with a diverse range of styles.

De Die weichen, komfortablen Sitzmöbel der Kollektion Santiago entstehen aus einem Spiel mit Proportionen. Schlanke, nicht sehr hohe Füße stützen die runden, großzügigen Volumen von Sitzfläche und Rückenlehne, volle Formen, die auch optisch Komfort und Entspannung signalisieren. Die Kollektion besteht aus einem Sofa und einem Lehnstuhl mit Fußstütze, die einzeln oder gemeinsam in stilistisch unterschiedlichen Räumen gut bestehen können.

Fr Avec leurs lignes douces et accueillantes, les fauteuils et les canapés Santiago jouent habilement avec les proportions. Les pieds fins et de hauteur réduite soutiennent les volumes ronds et généreux de l'assise et du dossier en créant des formes pleines qui, y compris sur le plan visuel, invitent au confort et au repos. La collection est composée d'un canapé et d'un fauteuil avec repose-pieds, utilisables seuls ou ensemble, dans les contextes les plus variés.



### Claesson Koivisto Rune

The Claesson Koivisto Rune studio was established in 1995 as a multidisciplinary architecture and design workshop, in line with the classic Scandinavian tradition, but with the aim of exploring new concepts, and pursuing the values of simplicity and innovation. The three Swedes have created architectural designs throughout the world and in every sector, from homes to restaurants, retail to executive buildings, as well as furniture ranges for numerous major international firms.

Other products by Claesson Koivisto Rune:  
Campo (Tacchini Edizioni), Doodle (Armchair, Chaise-longue) ↳ Vol. B p.082, Doodle (Chair, Stool) ↳ Vol. B p.228, Isola ↳ Vol. B p.114, Kelly B ↳ Vol. B p.296, Kelly C ↳ Vol. B p.202, Kelly C Basic ↳ Vol. B p.202, Kelly E ↳ Vol. B p.072, Kelly H ↳ Vol. B p.072, Kelly L+F ↳ Vol. B p.072, Kelly O ↳ Vol. B p.296, Kelly S ↳ Vol. B p.072, Kelly T ↳ Vol. B p.266, Kelly V ↳ Vol. B p.210, Kelly W ↳ Vol. B p.296, Lima ↳ p.078, Misura S/M ↳ Vol. B p.150, Montevideo (Sofa, Armchair, Ottoman) ↳ p.056, Montevideo (Chair) ↳ Vol. B p.222, Pisa ↳ Vol. B p.100, Quartier ↳ Vol. B p.176, Spin ↳ Vol. B p.182, Split ↳ Vol. B p.260

#### Technical informations



Sofa ↳ p.205

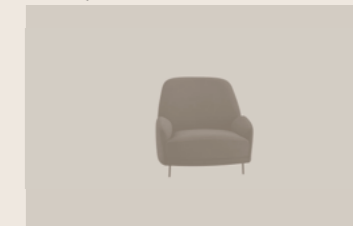

Armchair ↳ p.205



Ottoman ↳ p.205

# Lima

La sensualità decorativa di forme generose elegantemente appoggiate a tratti sottili, un irresistibile contrasto che disegna spazi da vivere e guardare.

Informazioni → p.083



Lima (Armchair),  
base T07 Black  
W 89 D 91 H 78,5 cm  
H seat 39,5 cm

Lima (Ottoman),  
base T07 Black  
W 89 D 70 H 39,5 cm

**Designer, Year:**  
Claesson Koivisto Rune, 2012

Lima è un sistema di divani, poltrone e pouf dal carattere distintivo di grande ispirazione. Il progetto del trio di architetti e designer svedesi Claesson Koivisto Rune unisce l'ergonomia di una seduta, profonda, accogliente, estremamente confortevole nell'introduzione del secondo cuscino dello schienale, promessa di un piacevole momento di relax o conversazione, all'accattivante estetica di un oggetto d'arredo in grado di attribuire un gusto raffinato a qualsiasi ambiente, pubblico o privato. Base tubolare in metallo verniciato, rivestimento in molteplici finiture.





## Lima

En The decorative sensuality of generous shapes elegantly poised above slender feet forms an enticing contrast that composes spaces to be lived in and enjoyed. Lima is a distinctive, inspired system of sofas, armchairs and ottomans. The project by the trio of Swedish designers, Claesson Koivisto Rune, weds the ergonomic pleasure of a deep, welcoming and outlandishly comfortable seat – thanks to the addition of a second cushion on the backrest that promises a pleasurable place to unwind or converse – to the irresistible aesthetic of a piece of furniture designed to lend sophistication to any room, public or private. Powder-coated tubular metal base and many different upholstery and finish options.

De Die dekorative Sinnlichkeit üppiger Formen, die elegant auf zierlichen Füßen ruhen, bildet einen unwiderstehlichen Kontrast für die Gestaltung von Räumen zum Wohnen und zum Anschauen. Lima ist eine Kollektion mit Sofas, Sesseln und Polsterhockern mit einzigartigem Charakter, der eine große Inspiration ist. Der Entwurf stammt von dem schwedischen Architekten- und Designertrio Claesson Koivisto Rune und verbindet die Ergonomie einer tiefen, behaglichen und extrem komfortablen Sitzfläche und eines zweiten, zusätzlichen Rückenkissens, das angenehme Momente der Entspannung oder des geselligen Beisammenseins verspricht, mit der hochkarätigen Ästhetik eines Einrichtungsgegenstands, der jedes öffentliche oder private Ambiente mit geschmackvoller Eleganz bereichert. Metallgestell mit Füßen aus lackiertem Rundprofil, Bezug in zahlreichen Ausführungen.

Fr La sensualité décorative de formes généreuses élégamment soutenues par des traits fins crée un contraste irrésistible qui dessine des espaces à vivre et à regarder. Lima est un système de canapés, fauteuils et poufs au caractère distinctif et très inspirant. Le projet du trio d'architectes et designers suédois Claesson Koivisto Rune conjugue l'ergonomie d'une assise, profonde, accueillante et extrêmement confortable grâce à l'introduction du deuxième coussin du dossier, promesse d'un moment agréable de détente ou de conversation, avec l'esthétique accrocheuse d'un meuble capable d'apporter une touche de raffinement à n'importe quel espace, public ou privé. Piètement tubulaire en métal peint, revêtement disponible en plusieurs finitions.



### Claesson Koivisto Rune

The Claesson Koivisto Rune studio was established in 1995 as a multidisciplinary architecture and design workshop, in line with the classic Scandinavian tradition, but with the aim of exploring new concepts, and pursuing the values of simplicity and innovation. The three Swedes have created architectural designs throughout the world and in every sector, from homes to restaurants, retail to executive buildings, as well as furniture ranges for numerous major international firms.

Other products by Claesson Koivisto Rune: Campo (Tacchini Edizioni), Doodle (Armchair, Chaise-longue) ⇨ Vol. B p.082, Doodle (Chair, Stool) ⇨ Vol. B p.228, Isola ⇨ Vol. B p.114, Kelly B ⇨ Vol. B p.296, Kelly C ⇨ Vol. B p.202, Kelly C Basic ⇨ Vol. B p.202, Kelly E ⇨ Vol. B p.072, Kelly H ⇨ Vol. B p.072, Kelly L+F ⇨ Vol. B p.072, Kelly O ⇨ Vol. B p.296, Kelly S ⇨ Vol. B p.072, Kelly T ⇨ Vol. B p.266, Kelly V ⇨ Vol. B p.210, Kelly W ⇨ Vol. B p.296, Misura S/M ⇨ Vol. B p.150, Montevideo (Sofa, Armchair, Ottoman) ⇨ p.056, Montevideo (Chair) ⇨ Vol. B p.222, Pisa ⇨ Vol. B p.100, Quartier ⇨ Vol. B p.176, Santiago ⇨ Vol. A p.070, Spin ⇨ Vol. B p.182, Split ⇨ Vol. B p.260

### Technical informations



Sofa ⇨ p.203

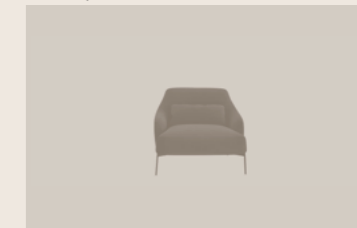

Armchair ⇨ p.203



Ottoman ⇨ p.203

Lima (Armchair),  
base T07 Black  
W 89 D 91 H 78,5 cm  
H seat 39,5 cm

Lima (Ottoman),  
base T07 Black  
W 89 D 70 H 39,5 cm

# Quadro

Quadro è un sistema modulare che consente di creare divani, poltrone e pouf di qualsiasi tipologia e dimensione.

Informazioni → p.091



**Designer, Year:**  
**Pietro Arosio, 2001**

Quadro è un sistema modulare che consente di creare divani, poltrone e pouf di qualsiasi tipologia e dimensione, risolvendo ogni necessità d'utilizzo e di ambientazione, con semplicità e senso del comfort: nei piccoli come nei grandi spazi. Tutti i rivestimenti sono sfoderabili.



Quadro (Sofa)  
W 98 D 98 H 66 + W 70 D 98 H 66  
+ W 70 D 70 H 36 H seat 36 cm

Lina (Armchair),  
base T43 Dark Walnut  
⇒ Vol. B p.032

⇒ Tacchini Edizioni: Narciso (Rug) designed  
by Umberto Riva, Daze (Low Table)  
designed by Truly Truly, Mantiqueira (Vase)  
designed by Domingos Tótor





## Quadro

En Quadro is a modular system which enables several configurations of sofas, armchairs and ottomans in a variety of combinations and dimensions addressing the needs of any space or environment with simplicity and comfort for large and small spaces. All covers are removable.

De Quadro ist ein modulares System: die schlichten Formen können sich zu Sofas, Sessels, Hocker und grossen Wohnlandschaften formen, für jede Nutzung und Lebensraum. Alle Bezüge sind abnehmbar.

Fr Quadro est un système modulaire qui permet de créer des canapes, des fauteuils et des poufs de quelconque typologie et dimension, pour résoudre chaque besoin d'emploi et d'ambiance, avec simplicité et le sens du confort : dans les petits comme dans les grands espaces. Tous les revêtements sont déhoussable.



Pietro Arosio

Pietro Arosio was born in 1946 in Lissone, near Milan. He learnt his profession at the research centre of a company specialising in the production of metal furniture for communal spaces. This experience led to the emergence of a design philosophy that developed over time through his work as an industrial designer. He began his career in 1972, and was already winning accolades in 1983, receiving the Casaviva d'Oro award. The fundamentals of his work include essentiality, research into new materials and technologies, and attention to detail and to the engineering implications of his designs. Pietro Arosio is fully aware of the emotional impact his products can have, and has worked in partnership with various internationally-acclaimed artists, including Nespolo, Del Pezzo, Hsiao Chin, Tilson, Rotella and Keizo. A number of his pieces have been exhibited at the Victoria and Albert Museum in London, and at the Munich modern art museum Die Sammlung.

Other products by Pietro Arosio:  
Intercity ⇨ p.190, Moon ⇨ Vol. B p.144,  
Parentesi ⇨ Vol. B p.132, Slalom ⇨ Vol. B p.192,  
Sliding ⇨ p.112, XL ⇨ Vol. B p.162

### Technical informations



Sofa, Armchair, Ottoman ⇨ p.204

Quadro (Sofa)  
W 98 D 98 H 66 + W 70 D 98 H 66  
+ W 70 D 70 H 36 H seat 36 cm

Polar Table (Low Table),  
finish T20 Shiny Black  
⇨ Vol. B p.312



# Dressed

Un divano a due o tre posti reso particolare da una lavorazione ispirata al mondo dello sportswear.

Informazioni → p.097

**Designer, Year:**  
Luca Nichetto, 2010

Un divano a due o tre posti reso particolare da una lavorazione ispirata al mondo dello sportswear: le imbottiture sono cucite direttamente nel rivestimento, come se fossero protezioni di un capo tecnico. Una soluzione capace di rendere fresco e contemporaneo un divano dalle linee rigorose, adatto per la casa ma anche per uffici e sale d'attesa.



Dressed

Dressed (Sofa),  
base T07 Black  
W 220 D 88 H 81 cm  
H seat 40 cm

Coot (Low Table),  
top T32 Black Marquinia  
Marble, base T07 Black  
→ Vol. B p.308





Dressed (Sofa),  
base T02 White  
W 220 D 88 H 81 cm  
H seat 40 cm

Quartier (Ottoman)  
⇒ Vol. B p.176

Coot (Low Table),  
top T29 Shiny  
White Carrara Marble,  
base T02 White  
⇒ Vol. B p.308

## Dressed

En A two or three-seat sofa with a distinctive sportswear-inspired look: the padding is sewn directly into the covers, as if it were the protection of a technical garment. A fresh, contemporary solution for a sofa with clean, rigorous lines, equally suitable for the home or for offices and waiting rooms.

De Ein zwei- oder dreisitziges Sofa in einer besonderen Ausfertigung, die sich an Sportbekleidung orientiert: die Polsterungen sind direkt auf den Bezug genäht, so wie der Schutz von Funktionsbekleidung. Das gibt dem Sofa der rigorosen Linien einen frischen, zeitgemäßen Charakter, perfekt nicht nur im häuslichen Bereich, sondern auch im Büro oder Wartezimmer.

Fr Un canapé à deux ou trois places rendu particulier par une fabrication s'inspirant aux vêtements sportifs : les rembourrages sont cousus directement dans le revêtement, comme s'il s'agissait des protections d'un vêtement technique. Une solution qui apporte une note fraîche et contemporaine à un canapé aux lignes rigoureuses, adapté aux espaces domestiques comme aux bureaux et aux salles d'attente.



Luca Nichetto

Luca Nichetto was born in Venice in 1976, and graduated in Industrial Design at IUAV university of architecture in Venice. In 1999 he launched his professional career, designing his first products in Murano glass. Later the same year he began working with Foscarini, designing a number of products for the firm and working as a consultant for research into new materials and product development (2001-2003). In 2006 he set up his own agency, Nichetto&Partners, dealing in both industrial design and design consultancy. He has received a number of international prizes, including the Gran Design Award 2008, the Chicago Atheneum Museum of Architecture Good Design Award 2008, the IF Product Design Award 2008 and the Elle Decoration International Design Awards 2009 (EDIDA) as Designer of the Year in the Young Designer Talent category. He has held workshops in numerous universities both in Italy and abroad, and has exhibited in Europe, the United States and Japan.

### Technical informations



Sofa ⇒ p.201

# Crystal

Crystal è un progetto dall'estetica sofisticata e inconsueta.

Informazioni → p.103



Crystal è un progetto dall'estetica sofisticata e inconsueta. La collezione comprende il divano – che combina linee oblique e linee curve ed è proposto in due dimensioni – e la poltrona dalla particolare forma tonda. Fil rouge della serie è la base invisibile, che fa sembrare le sedute sospese. Divani e poltrone vivono da soli oppure possono essere accostati per dare vita a composizioni suggestive ed efficaci, dentro ambienti domestici così come negli spazi contract.

**Designer, Year:**  
PearsonLloyd, 2011

Crystal

Crystal (Sofa)  
W 213 D 85 H 68 cm  
H seat 46 cm



Crystal (Sofa)  
W 213 D 85 H 68 cm  
H seat 46 cm

Crystal (Armchair)  
W 96 D 80 H 68 cm  
H seat 43 cm

## Crystal

Cage (Low Table), top T42  
Bronzed Mirror, base  
T25 Matt Champagne Gold  
⇒ Vol. B p.302



## Crystal

En Crystal is a design with a sophisticated and unusual aesthetic. The collection includes a sofa – which combines oblique and curved lines, and comes in two sizes – and an armchair with a distinctive round shape. The key feature in both cases is the invisible base, which gives the impression that they are floating above the ground. Sofas and armchairs can stand alone or be grouped together to create spellbindingly effective compositions that look great both in domestic and contract settings.

De Crystal ist ein Entwurf von raffinierter, origineller Ästhetik. Die Kollektion besteht aus Sofa – in dem sich schräge und runde Linien verbinden, angeboten in zwei Größen – und Fauteuil in einer sehr besonderen, rundlichen Form. Fil rouge ist die unsichtbare Basis, die dem Sitzmöbel eine schwebende Optik verleiht. Sofas und Fauteuils können einzeln eingesetzt werden oder zu optisch sehr effektvollen Kompositionen für den häuslichen Bereich, aber auch für Objekteinrichtungen verbunden werden.

Fr Crystal est un projet à l'esthétique sophistiquée et inhabituelle. La collection comprend le canapé – qui combine des lignes obliques et des lignes courbes et est proposé en deux dimensions – et le fauteuil avec sa forme ronde particulière. Le fil rouge de la série est la base invisible, qui donne l'impression que les éléments sont suspendus. Les canapés et les fauteuils peuvent être utilisés seuls ou regroupés pour donner vie à des compositions suggestives et efficaces, dans des environnements domestiques comme dans les espaces collectifs.



### PearsonLloyd

PearsonLloyd is one of the leading names in contemporary British design, and this multidisciplinary studio works in a wide range of sectors: from furnishing to public spaces to brand development. Established by Luke Pearson and Tom Lloyd in 1997, the studio has received numerous acknowledgements and accolades in both Europe and the United States. The British design duo write regularly for major design magazines, as well as acting as "visiting lecturers" at the École Cantonale d'Art in Lausanne.

Other products by PearsonLloyd:  
 Crystal (Armchair) → Vol. B p.108, Eddy → Vol. B p.240, Fixie → Vol. B p.252, Galleria → p.148, Ischia → p.124, Nebula (Tacchini Edizioni), Polar → p.162, Polar Perch → p.170, Polar Table → Vol. B p.312, Quilt → p.062, Stone High/Low → p.180

### Technical informations



Sofa → p.201



Armchair → p.201

Crystal (Sofa)  
 W 213 D 85 H 68 cm  
 H seat 46 cm

Crystal (Armchair)  
 W 96 D 80 H 68 cm  
 H seat 43 cm

Sancarlo (Armchair), base  
 T06 Grey → Vol. B p.120

Cage (Low Table),  
 top T32 Black Marquinia  
 Marble, base T07 Black  
 → Vol. B p.302

Contract

# Labanca

Un modello dalla progettualità multifunzionale d'avanguardia, pensato per spazi caratterizzati dal gusto internazionale del design che arreda con originale essenzialità e minimalismo.

Informazioni → p.111



**Designer, Year:**  
Lievore Altherr Molina, 2004

Sofa, Armchair

La semplicità di una linea netta e la proporzione estetica di volumi sottili di elegante simmetria. Labanca, design by Lievore Altherr Molina, è un divano dalla struttura leggera interamente imbottita, costituita dall'elemento unico della seduta autoportante, che accoglie lo schienale delicatamente inclinato. Infinite le possibilità compositive, con una modularità estremamente accattivante nella ripetizione. Ideale negli spazi contract, pubblici e privati, nelle aree di attesa di studi e ambienti di varie dimensioni, gioca con rivestimenti e colori per un effetto visivo coinvolgente, che esalta la bellezza delle geometrie cromatiche. Il divano Labanca è completato dal tavolino Labanca Table.











## Labanca

En Multifunctional leading-edge design distinguishes this style, meant to enhance spaces with an international sense of decor that tends to the unique and minimalist. The clean lines and elegant proportions spell simplicity wrought of slender shapes and sophisticated symmetry. Labanca, designed by Lievore Altherr Molina, is an entirely upholstered, light-as-air sofa formed by a self-supporting seat upon which a gently slanted backrest is delicately perched. The number of possible arrangements is limitless, thanks to the extremely eye-catching repetition of its modular structure. A perfect fit for contract spaces, public and private, in waiting rooms, offices and rooms of various sizes, the interplay of upholstery options and colors yields an engaging visual effect that plays up the beauty of the colorful geometric shapes. Complementing the Labanca sofa is the Labanca side table.

De Ein Modell mit multifunktionellem, avantgardistischem Design, gedacht für Räume, die durch den internationalen Geschmack einer essentiellen und minimalistischen Einrichtung geprägt sind. Die Schlichtheit einer klaren Linie und die ästhetischen Proportionen schlanker Volumen mit eleganter Symmetrie. Labanca vom Designer Lievore Altherr Molina ist ein Sofa mit einem leichten, komplett gepolsterten Gestell und besteht aus einem einzigen, selbsttragenden Sitzelement, an dem die leicht nach hinten geneigte Rückenlehne angebracht ist. Die einzelnen Elemente der Kollektion bieten zahllose Gestaltungsmöglichkeiten mit einer Modularität, die durch ihre Wiederholbarkeit extrem ansprechend ist. Das Sofa ist ideal für öffentliche und private Objekteinrichtungen und Wartebereiche in Studios und Räumlichkeiten unterschiedlicher Größe und spielt mit unterschiedlichen Bezügen und Farben, die ein Gesamtbild schaffen, das die Schönheit der farblichen Geometrien unterstreicht. Ergänzt wird das Sofa Labanca durch den Couchtisch Labanca Table.

Fr Ce modèle foisonnant de possibilités projectuelles novatrices est conçu pour des espaces caractérisés par un style international de design qui meuble avec une originalité essentielle et minimaliste. La simplicité d'une ligne nette et la proportion esthétique de volumes minces d'une symétrie élégante. Le canapé Labanca, dessiné par Lievore Altherr Molina, arbore une structure légère entièrement rembourrée, composée d'un élément unique d'assise autoportant qui accueille un dossier délicatement incliné. Les possibilités de composition sont infinies et sa modularité extrêmement captivante dans la répétition. Idéal dans les espaces contract, publics et privés, dans les espaces d'attente des agences et les locaux de différentes tailles, il joue avec les revêtements et les couleurs pour un effet visuel accrocheur qui rehausse la beauté des géométries chromatiques. Le canapé Labanca est assorti de la table basse Labanca Table.



Lievore Altherr Molina

Born in 1948, Alberto Lievore studied architecture in Buenos Aires. In the early years he focused not only on design, but also on the production and marketing of furniture, then, having moved to Barcelona, he was part of the Grupo Berenguer (1977), a leading name in Spanish design. In 1984 he inaugurated his own studio, focusing on industrial design, and on consultancy and art direction for a number of firms. His partners are designer and stylist Jeannette Altherr, who specializes in objects and spaces for children, and Manel Molina, who again brings with him vast and varied experiences in the industrial and exhibition design sectors.

Products by Lievore Altherr Molina:  
Baobab ⇨ Vol. B p.126, Girola ⇨ Vol. B p.166,  
Havana ⇨ p.118, Labanca Table ⇨ Vol. B p.320,  
Nara ⇨ Vol. B p.324

### Technical informations



Sofa ⇨ p.202

Labanca (Armchair)  
W 80 D 62 H 74 cm  
H seat 39,5 cm

Labanca Table (Low Table),  
top T38 White Rear  
Painted Glass ⇨ Vol. B p.320

Domestic, Contract

Sofa, Sofa Bed

# Sliding

Un divano essenziale ed elegante,  
che si trasforma in un  
comodo letto a due piazze.

Informazioni → p.117



Brevettato  
Patented

Designer, Year:  
Pietro Arosio, 2000

Un divano essenziale ed elegante, caratterizzato dalla base in pressofusione di alluminio, che si trasforma in un comodo letto a due piazze, semplicemente abbassando lo schienale con meccanismo brevettato. I cuscini con imbottitura in piuma d'oca, sono funzionali ad entrambi gli utilizzi. Tutti i rivestimenti sono sfoderabili.



Sliding

Sliding (Sofa, Sofa Bed),  
base T03 Grey  
W 204 D 100/144 H 83/42 cm  
H seat 42 cm





## Sliding

En A practical and extremely elegant sofa characterized by its base in cast aluminium which transforms itself into a comfortable double bed simply by lowering the backrest via the patented mechanism. The cushions are upholstered in duck down. All covers are removable.

De Ein elegantes schlichtes Sofa, zeichnet sich durch sein Aluminiumgestell auf Rollen aus, verwandelbar in ein bequemes Doppelbett durch einfaches Runterdrücken der Lehne. Die Kissen mit Daunenfüllung sind für beide Anwendungen funktionell. Alle Bezüge sind abziehbar.

Fr Un canapé essentiel et élégant, caractérisé avec la base moulage sous pression en aluminium, qui se transforme dans un lit confortable à deux places, simplement en baissant le dossier arrière avec le mécanisme breveté. Les coussins rembourrés avec plume d'oie sont fonctionnels pour les deux emplois. Tous les revêtements sont amovibles.



Pietro Arosio

Pietro Arosio was born in 1946 in Lissone, near Milan. He learnt his profession at the research centre of a company specialising in the production of metal furniture for communal spaces. This experience led to the emergence of a design philosophy that developed over time through his work as an industrial designer. He began his career in 1972, and was already winning accolades in 1983, receiving the Casaviva d'Oro award. The fundamentals of his work include essentiality, research into new materials and technologies, and attention to detail and to the engineering implications of his designs. Pietro Arosio is fully aware of the emotional impact his products can have, and has worked in partnership with various internationally-acclaimed artists, including Nespolo, Del Pezzo, Hsiao Chin, Tilson, Rotella and Keizo. A number of his pieces have been exhibited at the Victoria and Albert Museum in London, and at the Munich modern art museum Die Sammlung.

Other products by Pietro Arosio:  
Intercity ⇨ p.190, Moon ⇨ Vol. B p.144,  
Parentesi ⇨ Vol. B p.132, Quadro ⇨ p.084,  
Slalom ⇨ Vol. B p.192, XL ⇨ Vol. B p.162

### Technical informations



Sofa, Sofa Bed ⇨ p.206

Sliding (Sofa, Sofa Bed),  
base T03 Grey  
W 204 D 100/144 H 83/42 cm  
H seat 42 cm

Domestic, Contract

Sofa, Sofa Bed

# Havana

Havana è una sintesi armoniosa di eleganza e flessibilità.

Informazioni → p.123

**Designer, Year:**  
Lievore Altherr Molina, 2005

Da elegante divano protagonista dello spazio, si trasforma in comodo letto dotato di contenitore, con un semplice gesto. Versatile anche l'estetica, grazie alla scelta fra più rivestimenti sfoderabili e basi con rivestimento in alluminio o wengè.



Havana

Havana (Sofa, Sofa Bed),  
base Aluminium  
W 225 D 102 H 69 cm  
H seat 38 cm





Havana (Sofa, Sofa Bed),  
base Aluminium  
W 225 D 102 H 69 cm  
H seat 38 cm

## Havana

En Havana is a synthesis of elegance and flexibility. From an elegant centrepiece of any space it can be transformed with a simple action into a bed with storage. Versatile also by virtue of the choice of a number removable covers and base options in aluminium or wengé finish.

De Havana ist eine Synthese aus Eleganz und Flexibilität. Aus einem Sofa der schlichten Linien wird mit einem einfachen Handgriff ein bequemes Bett mit praktischem Stauraum. Die Bezüge sind abziehbar, das Untergestell mit Verkleidung aus Aluminium oder Wengé.

Fr Havana est une synthèse harmonieuse d'élégance et de flexibilité. Il se transforme de canapé élégant protagoniste de l'espace à un lit confortable équipé de rangement, avec un simple geste. Versatile dans l'esthétique, grâce au choix parmi plusieurs revêtements amovibles et bases avec revêtement en aluminium ou wengé.



Lievore Altherr Molina

Born in 1948, Alberto Lievore studied architecture in Buenos Aires. In the early years he focused not only on design, but also on the production and marketing of furniture, then, having moved to Barcelona, he was part of the Grupo Berenguer (1977), a leading name in Spanish design. In 1984 he inaugurated his own studio, focusing on industrial design, and on consultancy and art direction for a number of firms. His partners are designer and stylist Jeannette Altherr, who specializes in objects and spaces for children, and Manel Molina, who again brings with him vast and varied experiences in the industrial and exhibition design sectors.

Products by Lievore Altherr Molina:  
Baobab ⇨ Vol. B p.126, Girola ⇨ Vol. B p.166,  
Labanca ⇨ p.104, Labanca Table ⇨ Vol. B p.320,  
Nara ⇨ Vol. B p.324

### Technical informations



Sofa, Sofa Bed ⇨ p.202



# Ischia

In principio sono le rocce plasmate dall'aria e dall'acqua, le venature dei sassi, le sovrapposizioni e gli incastri perfetti creati dalla natura.

Informazioni → p.131



Poi, quando la forma organica ispira quella artistica, nascono i monoliti di Barbara Hepworth e le opere astratte di Serge Poliakoff. Si colloca su questa linea il nuovo progetto di PearsonLloyd, un sistema modulare influenzato da forme naturali e suggestioni artistiche, destinato ad ambienti collettivi. Ischia è composto di elementi singoli, liberamente combinabili: i sedili sono singoli o doppi, senza schienale o con schienale. Il sistema offre la possibilità di aggiungere il tavolino o il paravento in paglia di Vienna, che separa e nasconde. L'essenzialità degli elementi, caratterizzati da forme morbide e linee oblique, è bilanciata dalle finiture importanti delle basi in legno o marmo che connettono tra loro gli elementi.

Awards: 2018 Wallpaper\* Design Award

Designer, Year:  
PearsonLloyd, 2017



Ischia (Modular System), base T49 Grey, yarn T85, table base T03 Grey, table top T32 Black Marquinia Marble





Ischia (Modular System), base T49 Grey,  
yarn T85, table base T03 Grey,  
table top T32 Black Marquinia Marble

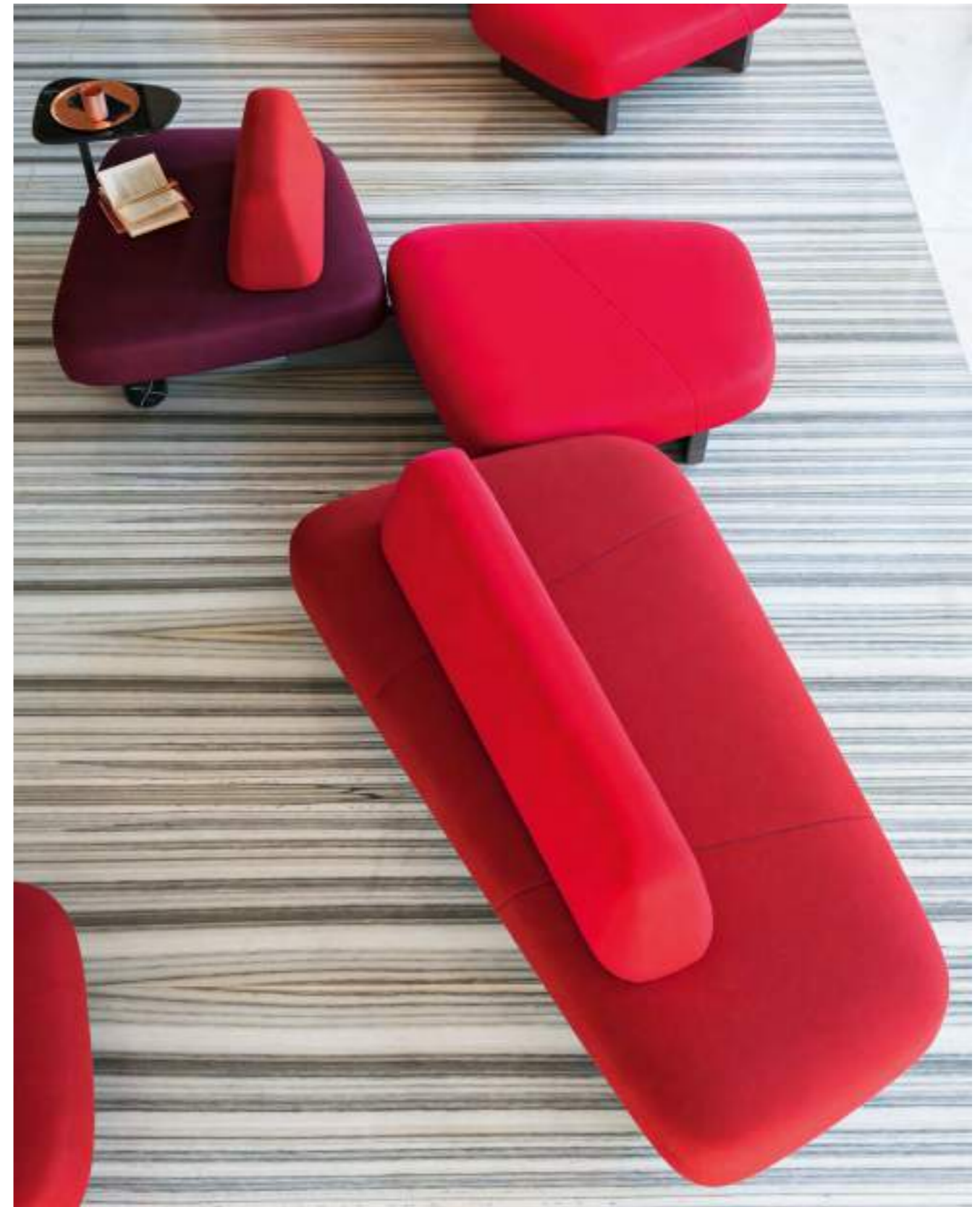

Ischia (Modular System), base T49 Grey,  
yarn T85, table base T03 Grey,  
table top T32 Black Marquinia Marble



Ischia (Screen), frame T49 Grey  
W 135,5 D 45 H 136,9 cm

## Ischia

En In the beginning there were rocks, shaped by the wind and the waters, veined stones, perfectly overlaid or slotted together by nature. Then, when organic shapes inspired artistic forms, we saw monoliths such as those of Barbara Hepworth and abstract paintings from Serge Poliakoff. Descended from this same line is the new design by Pearson Lloyd, a modular system influenced by natural shapes and artistic allusions, destined for collective settings. Ischia comprises a number of freely-combinable individual components: the seats can be single or double, and come with or without a backrest. The system also offers the possibility of adding a table or a woven cane screen, to keep any given area separate and hidden away. The components have an essential feel, with soft shapes and oblique lines, balanced out by the strong finishes of the wood or marble bases that connect them up.

De Am Anfang wurden die Felsen von Luft und Wasser geformt, Steinadern, Überlagerungen und perfekte Verbindungen, die von der Natur geschaffen werden. Dann, wenn die organische Form die künstlerische inspiriert, entstehen die Monolithen von Barbara Hepworth und die abstrakten Arbeiten von Serge Poliakoff. Auf dieser Linie bewegt sich das neue Projekt von PearsonLloyd, ein modulares System für Gemeinschaftsräume, das von natürlichen Formen und künstlerischen Impressionen beeinflusst ist. Ischia besteht aus einzelnen Elementen, die beliebig kombinierbar sind: einzel- oder doppelsitzig, mit oder ohne Rückenlehne. Das System kann durch einen kleinen Tisch oder einen Schirm aus Wiener Geflecht zur Trennung oder als Sichtschutz ergänzt werden. Der Schlichtheit der Elemente, geprägt durch weiche Formen und schräge Linien, stehen anspruchsvolle Sockel aus Holz oder Marmor zur Verbindung der Elemente gegenüber.

Fr Au commencement, il y a les roches modelées par l'air et par l'eau, les veines des pierres, les superpositions et les encastements parfaits créés par la nature. Puis, quand la forme organique inspire la forme artistique, naissent les monolithes de Barbara Hepworth et les œuvres abstraites de Serge Poliakoff. C'est dans cette ligne que se place le nouveau projet de PearsonLloyd, un système modulaire influencé par des formes naturelles et des suggestions artistiques, destiné à des espaces collectifs. Ischia est composé d'éléments distincts se composant librement : les éléments d'assise sont simples ou doubles, avec ou sans dossier. Le système offre la possibilité d'ajouter la table basse ou le paravent en cannage, qui sépare et cache. L'aspect essentiel des éléments, caractérisés par des formes douces et des lignes obliques, est équilibré par les finitions importantes des bases en bois ou en marbre qui relient les éléments.



PearsonLloyd

PearsonLloyd is one of the leading names in contemporary British design, and this multidisciplinary studio works in a wide range of sectors: from furnishing to public spaces to brand development. Established by Luke Pearson and Tom Lloyd in 1997, the studio has received numerous acknowledgements and accolades in both Europe and the United States. The British design duo write regularly for major design magazines, as well as acting as "visiting lecturers" at the École Cantonale d'Art in Lausanne.

Other products by PearsonLloyd:  
Crystal ⇨ p.098, Crystal (Armchair) ⇨ Vol. B p.108,  
Eddy ⇨ Vol. B p.240, Fixie ⇨ Vol. B p.252,  
Galleria ⇨ p.148, Nebula (Tacchini Edizioni),  
Polar ⇨ p.162, Polar Perch ⇨ p.170, Polar Table ⇨ Vol. B  
p.312, Quilt ⇨ p.062, Stone High/Low ⇨ p.180

### Technical informations



Modular System, Screen ⇨ p.212, 213

# Chill-Out

Il design si fa sistema nel progetto Chill-Out, design Gordon Guillaumier. Geometria lineare e fruibilità multipla danno forma a una creazione componibile e personalizzabile, per dare vita a diversi ambienti in un solo spazio.

Informazioni → p.139



Chill-Out è il sistema di divani e poltrone, completo di tavolini, che costruisce aree di condivisione e relazione dall'estetica ordinata ed elegantemente all'avanguardia, racchiudendo nello spazio individuato la bellezza del disegno e il piacere del comfort. Gli elementi Chill-Out si inseriscono nell'ambiente singolarmente, in composizione lineare o in composizione ad angolo. Il risultato visivo è di grande effetto, grazie alla regolarità ripetuta delle forme, con struttura in metallo e sedute e schienali imbottiti, completata dai raffinati tavolini in marmo di Carrara, Calacatta, Basaltina o Travertino nero, in finitura opaca.

Designer, Year:  
Gordon Guillaumier, 2013



Chill-Out (Modular System), base T03 Grey  
W 144 D 69 H 71 cm  
H seat 44 cm

Chill-Out (Armchair), base T03 Grey  
W 74 D 69 H 71 cm  
H seat 44 cm

Split (Low Table), top T57 White, base T02 White → Vol. B p.260







Chill-Out (Modular System),  
base T03 Grey, table top  
T35 Matt Basaltina Marble  
W 144 D 69 H 71 H seat 44 cm

Chill-Out (Armchair),  
base T03 Grey  
W 74 D 69 H 71 cm  
H seat 44 cm

## Chill-Out

En Design becomes a system in the Chill-Out project by Gordon Guillaumier. Linear geometries lend themselves to many different uses, shape-shifting into customizable sectional arrangements that can delineate different areas in a single space. Chill-Out is a system of sofas and armchairs, complete with in-line coffee tables, that constructs conversation areas with a businesslike aesthetic that exudes avant-garde elegance, enveloping the space it defines in the beauty of design and the pleasure of comfort. Chill-Out elements can stand alone, in linear arrangements, or be combined in corner sectional layouts. Thanks to the repeated uniformity of the shapes, the visual effect is ensured. The metal structure and upholstered seats and backrests are complemented by elegant coffee tables in Carrara, Calacatta or Basaltina marble or black Travertine with matte finish.

De Das Projekt Chill-Out des Designers Gordon Guillaumier macht Design zu einem System. Eine lineare Geometrie und die vielseitige Nutzung bieten kombinierbare und personalisierbare Gestaltungsmöglichkeiten, mit denen sich unterschiedliche Ambiente im gleichen Raum schaffen lassen. Chill-Out ist ein System mit Sofas, Sesseln und Couchtischen für die Gestaltung gemeinschaftlich genutzter Bereiche, die sich durch ihre geordnete Ästhetik und ihren eleganten und avantgardistischen Charakter auszeichnen und die Schönheit des Designs mit dem Vergnügen des Komforts verbinden. Die Elemente von Chill-Out lassen sich einzeln, in linearen Kombinationen oder in abgewinkelten Kombinationen in den Raum einfügen. Das Ergebnis hat durch die wiederholte Regelmäßigkeit der Formen eine große visuelle Wirkung, die mit den einzelnen Elementen mit Metallgestell und gepolsterten Sitzflächen und Rückenlehnen erzielt wird, in Kombination mit eleganten Couchtischen aus Marmor vom Typ Carrara, Calacatta, Basaltina oder schwarzem Travertino mit matter Oberfläche.

Fr Le design devient système dans le projet Chill-Out, conçu par Gordon Guillaumier. La géométrie linéaire et les multiples possibilités d'utilisation donnent forme à une création modulaire et personnalisable, permettant de créer des zones diverses dans un même espace. Chill-Out est un système de canapés et fauteuils, comprenant également des tables basses, qui construit des espaces de partage et de relation dotés d'une esthétique ordonnée et élégamment novatrice, en délimitant dans l'espace identifié la beauté du dessin et le plaisir du confort. Les éléments Chill-Out s'intègrent de différentes manières dans la pièce : seul, en composition droite ou en composition d'angle. Le résultat visuel est impressionnant grâce à la régularité répétée des formes – avec un piètement métallique et des assises et dossiers rembourrés – que viennent compléter avec raffinement des tables basses en marbre de Carrare, Calacatta, Basaltina ou Travertin noir, en finition mate.



Gordon Guillaumier

Gordon Guillaumier was born in 1966, and was educated firstly in Malta, then in Switzerland, England and Italy. He graduated from IED in Milan (1988-91), before specializing in design at the Domus Academy, Milan (1992). In 1993 he began working with Baleri Associati, as well as collaborating with architect Rodolfo Dordoni. In 2002 he set up his own design studio in Milan, principally working on product design, but also for design consultancy projects. In 2006 he lectured in industrial design at Milan's Politecnico university.

Other products by Gordon Guillaumier:  
Cage ⇨ Vol. B p.302, Chill-Out High ⇨ p.140,  
Coot ⇨ Vol. B p.308, Face to Face ⇨ p.044,  
Ledge ⇨ Vol. B p.316, Soap ⇨ Vol. B p.290,  
Spindle ⇨ Vol. B p.274

### Technical informations

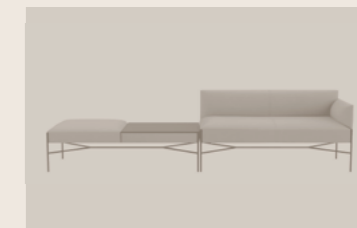

Modular System ⇨ p.207



Low Table ⇨ p.207

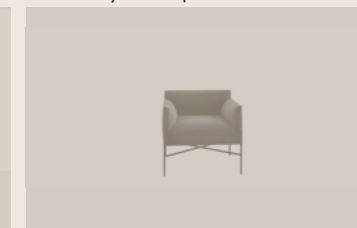

Armchair ⇨ p.207



# Chill-Out High

Quando la bellezza è disegnata per superare i limiti, andando oltre gli standard di comfort e funzionalità, per migliorare e ispirare ancora.

Informazioni → p.147



Chill-Out High di Tacchini propone un inedito sistema di sedute, caratterizzato da schienale imbottito extra alto, accostabile anche a elementi con schienale classico, della stessa collezione. Il piano scrittoio è proposto nelle finiture marmo Basaltina opaco, marmo Carrara opaco o marmo Calacatta lucido.

Awards: 2016 Archiproducts Design Awards

**Designer, Year:**  
Gordon Guillaumier, 2016

Chill-Out High

141



Chill-Out High (Modular System),  
base T24 Satin Chrome  
W 144 D 69 H 121 H seat 44 cm

Ledge (Low Table), top T31 White  
Calacatta Marble, base T24  
Satin Chrome → Vol. B p.316

140



Chill-Out High (Modular System),  
base T02 White, table top  
T35 Matt Basaltina Marble  
W 144 D 69 H 121 H seat 44 cm

Chill-Out (Modular System, Low  
Table), base T02 White, table  
base T02 White, table top T35 Matt  
Basaltina Marble → p.132

### Chill-Out High

Kelly C (Chair),  
base T02 White  
→ Vol. B p.202

Ledge (Low Table), top  
T35 Matt Basaltina  
Marble, base T02 White  
→ Vol. B p.316





## Chill-Out High

En When beauty is designed to go beyond the limits, over and above the standards of comfort and functionality, to further improve and inspire. Chill-Out High by Tacchini is a unique seating system, with a super-high padded back, which can be combined with normal-height elements from the same collection. The desk surface is available in the following marble finishes: matt Basaltina, matt Carrara or polished Calacatta.

De Wenn Schönheit geschaffen wird, um Grenzen zu überwinden, für mehr Komfort und Funktion, um Verbesserung und Anregung zu liefern. Chill-Out High von Tacchini sind innovative Sitzmöbel, die in einer extrahohen, gepolsterten Rückenlehne ihr besonderes Merkmal haben. Sie können auch mit Elementen mit klassischer Rückenlehne der gleichen Kollektion kombiniert werden. Die Elemente Chill-Out High zeichnen sich durch ein lineares Design aus und können in jedem Detail bedürfnisgerecht gestaltet werden. Die Schreibplatte wird in den Ausführungen Marmor Basaltina matt, Marmor Carrara matt oder Marmor Calacatta glänzend angeboten.

Fr Quand la beauté est dessinée pour dépasser les limites, en allant au-delà des standards de confort et de fonctionnalité, pour améliorer et inspirer encore et toujours. Le design Chill-Out High de Tacchini propose un système inédit de sièges, caractérisé par un dossier rembourré extra haut, juxtaposable également à des éléments avec dossier classique, de la même collection. Le plateau écritoire est proposé dans les finitions marbre Basaltina mat, marbre Carrara mat ou marbre Calacatta brillant.



### Gordon Guillaumier

Gordon Guillaumier was born in 1966, and was educated firstly in Malta, then in Switzerland, England and Italy. He graduated from IED in Milan (1988-91), before specializing in design at the Domus Academy, Milan (1992). In 1993 he began working with Baleri Associati, as well as collaborating with architect Rodolfo Dordoni. In 2002 he set up his own design studio in Milan, principally working on product design, but also for design consultancy projects. In 2006 he lectured in industrial design at Milan's Politecnico university.

Other products by Gordon Guillaumier:  
Cage ↪ Vol. B p.302, Chill-Out ↪ p.132, Coot ↪ Vol. B p.308, Face to Face ↪ p.044, Ledge ↪ Vol. B p.316, Soap ↪ Vol. B p.290, Spindle ↪ Vol. B p.274

### Technical informations

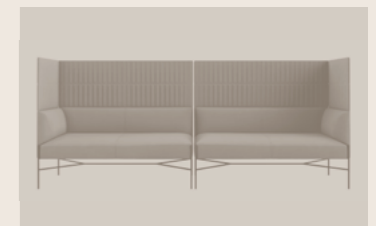

Modular System ↪ p.208

Chill-Out High (Modular System),  
base T02 White  
W 144 D 69 H 121 H seat 44 cm

Ledge (Low Table), top  
T31 White Calacatta  
Marble, base T02 White  
↪ Vol. B p.316

# Galleria

Galleria è un progetto completo che consente di creare le più svariate soluzioni: panca lineare, seduta angolare doppia, isola dedicata all'attesa, al relax o alla convivialità.

Informazioni → p.161



**Designer, Year:**  
PearsonLloyd, 2013

Tutto questo partendo da una semplice barra d'acciaio, sulla quale si agganciano liberamente elementi dalle forme geometriche semplici in legno, pelle, tessuto, marmo e metallo verniciato in diversi colori. Ogni composizione può essere utilizzata da sola oppure in gruppi, moltiplicando all'infinito le possibilità d'uso e armonizzandosi con qualsiasi spazio o stile.

Awards: Interior Innovation Awards 2014

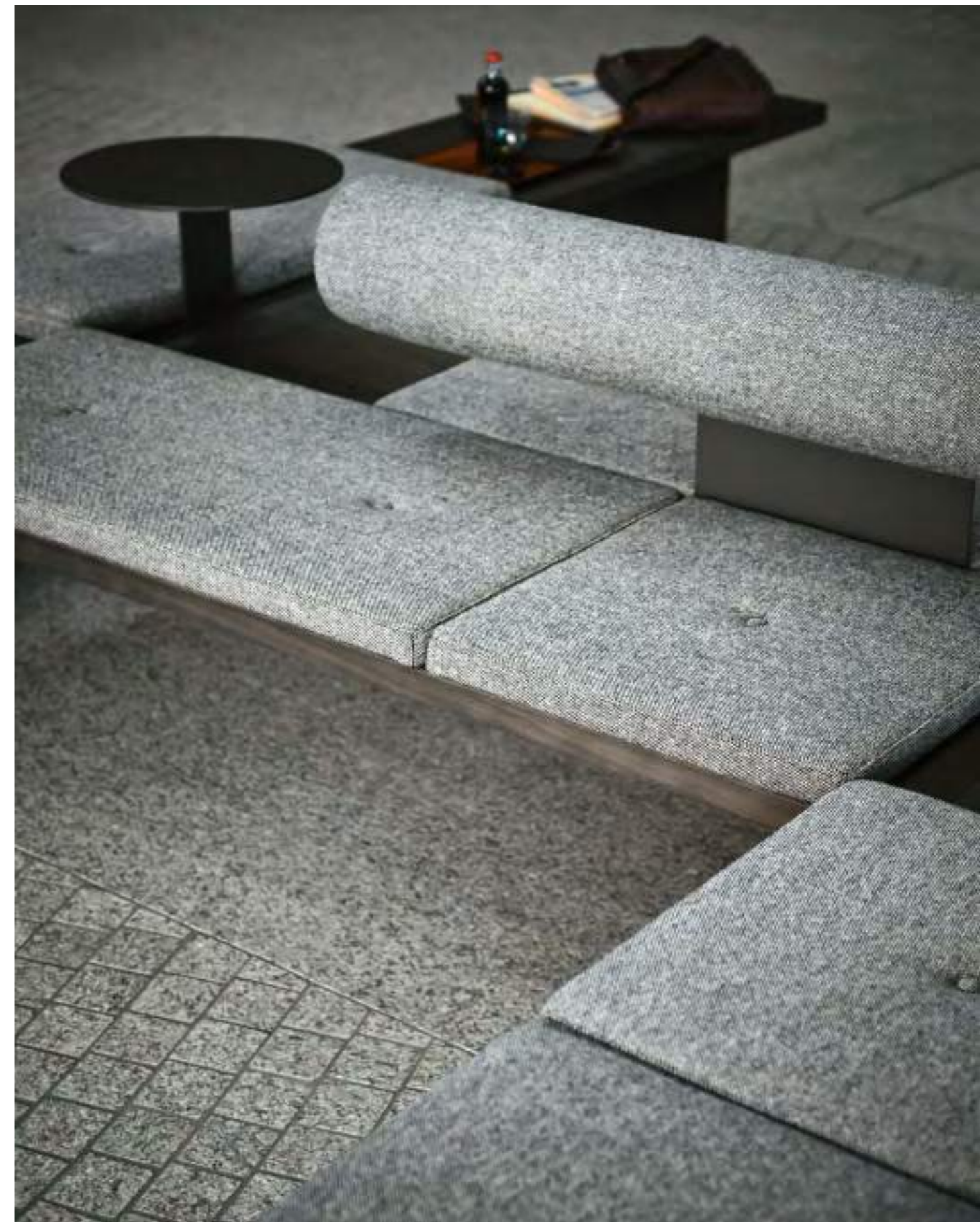

Galleria

Galleria S-Shape (Modular System),  
frame T49 Grey, base  
T03 Grey, table top T03 Grey  
W 400 D 250 H 42 cm

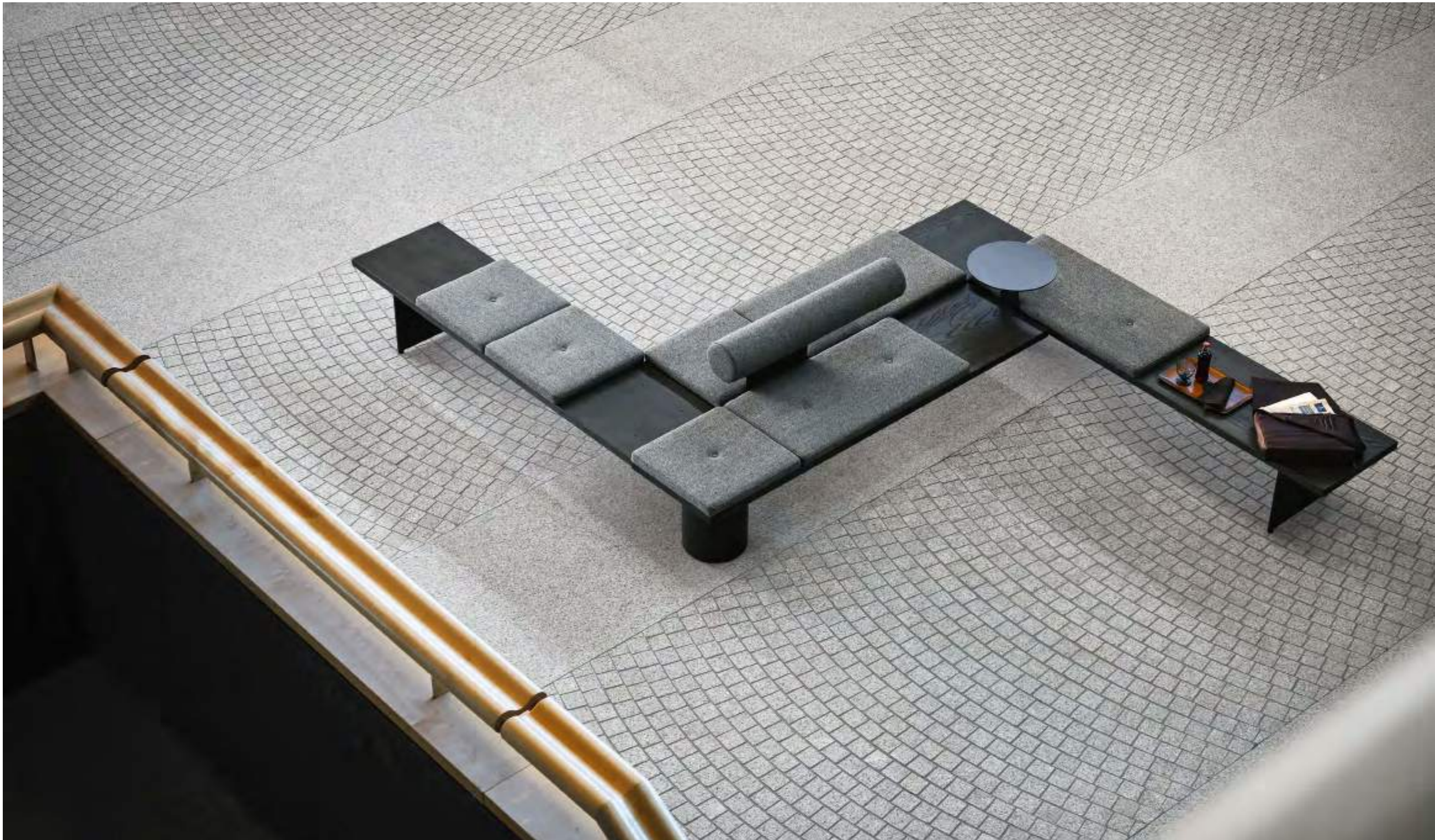



Galleria Double (Modular System),  
frame T45 Natural, base T02 White  
Ash, table top T02 White  
W 300 D 98 H 42 cm



Galleria (Modular System),  
frame T45 Natural, base T02 White  
Ash, occasional side table top  
T30 Matt White Carrara Marble





Galleria B (Modular System), frame T45 Natural  
Ash, base T02 White, table top T02 White, occasional  
side table top T30 Matt White Carrara Marble  
W 250 D 250 H 42 cm





Galleria Double (Modular System),  
frame T45 Natural Ash, base T02  
White, table top T02 White  
W 300 D 98 H 42 cm



Galleria Shear (Modular System),  
frame T45 Natural Ash, base T02  
White, table top T02 White  
W 400 D 98 H 42 cm

## Galleria

En Galleria is a complete design with the versatility to create a vast range of different solutions: a linear bench, a double corner seat, an island perfect for waiting, relaxation and conviviality. And all this is developed around a simple steel bar, onto which to freely attach the various simple, geometrically-shaped elements in wood, leather, fabric, marble and metal painted in a range of colours. Each composition can be used on its own or in groups, offering endless possibilities for use that will blend beautifully with any space or style.

De Galleria ist ein komplettes Angebot für unterschiedlichste Lösungen: gerade Sitzbänke, doppelte Eckbank, Sitzinsel für den Wartebereich, zum Relaxen, für kollektive Räume. All das geht von einer einfachen Stahlschiene aus, in die Elemente in schlichten, geometrischen Formen aus Holz, Leder, Stoff, Marmor oder Metall in verschiedenfarbiger Lackierung einhängbar sind. Jede Kombination kann einzeln oder in Gruppen eingesetzt werden, um die Möglichkeit ihrer Nutzung vielfach zu erweitern und harmonisch auf jeden Raum und Einrichtungsstil abzustimmen.

Fr Galleria est un projet complet qui permet de créer les solutions les plus variées : une banquette linéaire, une banquette d'angle double, un îlot consacré à l'attente, à la détente ou à la convivialité. Tout cela en partant d'une simple barre d'acier, sur laquelle on accroche librement des éléments de formes géométriques simples réalisés dans des matériaux riches de personnalité : bois, cuir, tissu et métal laqué en différentes couleurs. Chaque composition peut être utilisée seule ou en groupes, en multipliant pratiquement à l'infini les possibilités d'emploi et en s'harmonisant avec n'importe quel espace ou style.



### PearsonLloyd

PearsonLloyd is one of the leading names in contemporary British design, and this multidisciplinary studio works in a wide range of sectors: from furnishing to public spaces to brand development. Established by Luke Pearson and Tom Lloyd in 1997, the studio has received numerous acknowledgements and accolades in both Europe and the United States. The British design duo write regularly for major design magazines, as well as acting as "visiting lecturers" at the École Cantonale d'Art in Lausanne.

Other products by PearsonLloyd:  
Crystal ⇨ p.098, Crystal (Armchair) ⇨ Vol. B p.108,  
Eddy ⇨ Vol. B p.240, Fixie ⇨ Vol. B p.252,  
Ischia ⇨ p.124, Nebula (Tacchini Edizioni),  
Polar ⇨ p.162, Polar Perch ⇨ p.170, Polar Table ⇨ Vol. B  
p.312, Quilt ⇨ p.062, Stone High/Low ⇨ p.180

### Technical informations

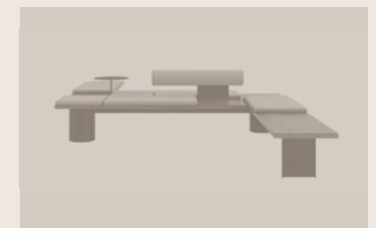

Modular System ⇨ p.209

# Polar

Polar è un sistema di sedute ispirato ai blocchi di ghiaccio dei mari del Nord.

Informazioni → p.169



**Designer, Year:**  
PearsonLloyd, 2006

Gli elementi che lo compongono sono caratterizzati da volumi pieni e tagli obliqui e si possono combinare tra loro per creare divani e poltrone, con o senza schienale. Versatile, accogliente e di grande impatto estetico, il sistema si completa con il tavolino Polar.



Polar

Polar (Modular System)  
W 234 D 107 H 73 cm  
H seat 37 cm

Polar (Ottoman)  
W 107 D 81,5 H 37 cm

Split (Low Table),  
top T57 White, base T02  
White → Vol. B p.260



Polar (Modular System)  
W 234 D 107 H 73 cm  
H seat 37 cm

Polar (Ottoman)  
W 107 D 81,5 H 37 cm

Polar

Polar Table (Low Table),  
finish T22 Yellow → Vol. B p.312

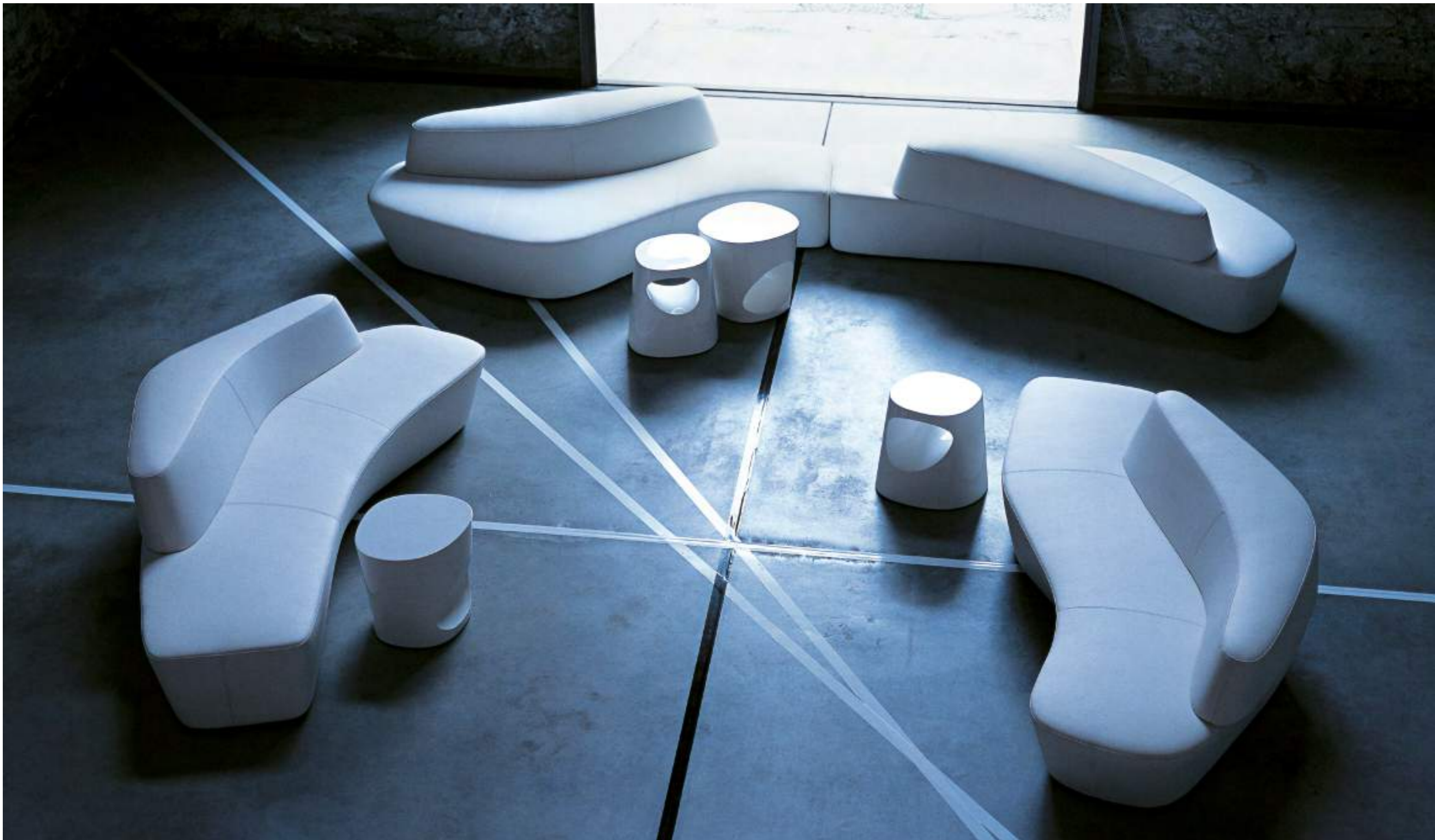



Polar (Modular System)  
W 234 D 107 H 73 cm  
H seat 37 cm

Polar (Armchair)  
W 107 D 81,5 H 67 cm  
H seat 37 cm

Polar Table (Low Table), finish T21 White  
⇒ Vol. B p.312

## Polar

En Polar is a seating system inspired by the icebergs of the northern seas. Its components all feature solid volumes and oblique lines, which can be combined to create sofas and armchairs, with or without backrests. Versatile, cosy and aesthetically striking, the system is perfectly complemented by Polar coffee table.

De Polar ist ein modulares System von Sitzelementen, die sich von der Form der Eisblöcke in den nördlichen Meeren anregen lassen. Die einzelnen Elemente – mit charakteristischen, vollen Volumen und schrägen Kanten – können beliebig zu Sofas oder Fauteuils mit oder ohne Rückenlehne kombiniert werden. Vielseitig, bequem und optisch sehr effektiv, wird das System durch ein Tischchen ergänzt.

Fr Polar est un système de sièges s'inspirant des blocs de glace des mers du Nord. Les éléments qui le composent sont caractérisés par des volumes pleins et des coupes obliques et peuvent se combiner entre eux pour créer des canapés et des fauteuils, avec ou sans dossier. Polyvalent, accueillant et d'un grand effet esthétique, le système est complété par la table basse Polar.



PearsonLloyd

PearsonLloyd is one of the leading names in contemporary British design, and this multidisciplinary studio works in a wide range of sectors: from furnishing to public spaces to brand development. Established by Luke Pearson and Tom Lloyd in 1997, the studio has received numerous acknowledgements and accolades in both Europe and the United States. The British design duo write regularly for major design magazines, as well as acting as "visiting lecturers" at the École Cantonale d'Art in Lausanne.

Other products by PearsonLloyd:  
Crystal ⇒ p.098, Crystal (Armchair) ⇒ Vol. B p.108,  
Eddy ⇒ Vol. B p.240, Fixie ⇒ Vol. B p.252,  
Galleria ⇒ p.148, Ischia ⇒ p.124, Nebula (Tacchini Edizioni), Polar Perch ⇒ p.170, Polar Table ⇒ Vol. B p.312, Quilt ⇒ p.062, Stone High/Low ⇒ p.180

### Technical informations

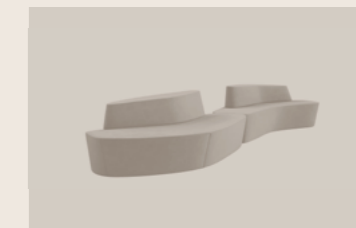

Modular System ⇒ p.214



Armchair ⇒ p.214

# Polar Perch

Un progetto creativo dalle molteplici visioni, che interpreta con intelligenza e originalità le esigenze di un vivere contemporaneo sempre più mobile e multiforme.

Informazioni → p.179

Polar Perch, design by PearsonLloyd, è costituito dall'accostamento di due elementi dalle morbide linee curve e diverse altezze, che si compongono a coppie complementari. Mentre l'elemento più basso, singolo e autonomo, presenta la funzione di seduta, quello più alto, in abbinamento, è utilizzabile come suo schienale, seconda seduta alta o piano di appoggio. Il design fortemente innovativo di questi elementi componibili permette di creare inedite forme di grande impatto estetico, con soluzioni personalizzabili per i diversi contesti di inserimento.

Designer, Year:  
PearsonLloyd, 2013

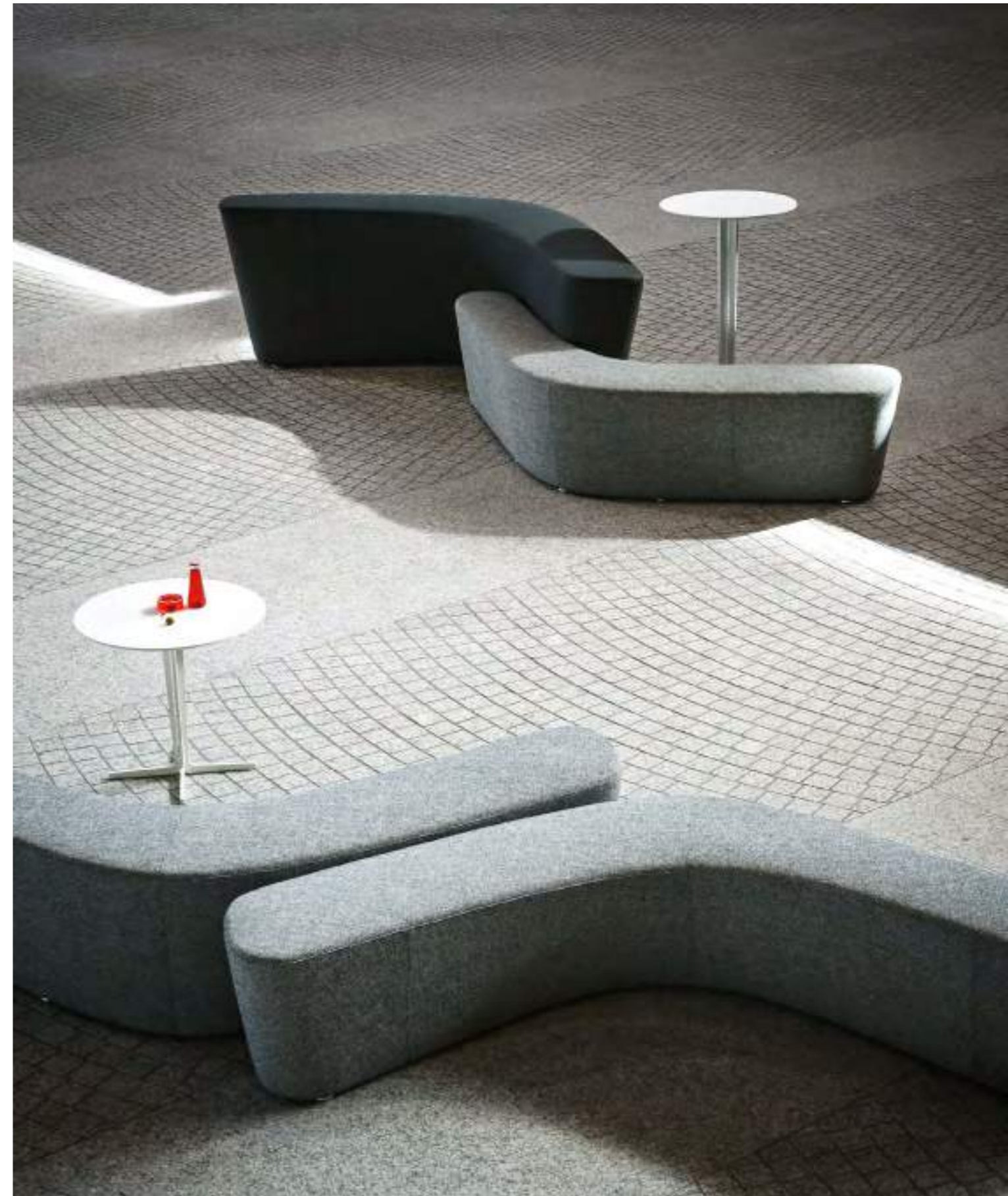











Polar Perch (Modular System)  
W 220 D 79 H 70 H seat 70 cm  
/W 207 D 84,5 H 46 H seat 46 cm

Polar (Modular System)  
→ p.162

## Polar Perch

En An ingenious design with many different perspectives, it intelligently interprets the uniqueness and needs of an increasingly mobile and multi-faceted contemporary lifestyle. Polar Perch, designed by PearsonLloyd, consists of the pairing of two softly curved elements of different heights that form complementary pairs. While the individual, stand-alone lower element functions as a seat, the higher piece, when paired with it, becomes a backrest, or additional higher bench seating, or a table-top surface. The innovative design of these modular pieces means they can be arranged to create unusual shapes of amazing aesthetic impact with customizable solutions for various types of settings.

De Ein kreatives Projekt mit umfassenden Visionen, das den Anspruch eines modernen und zunehmend mobileren und vielseitigeren Lebensstils mit Intelligenz und Originalität interpretiert. Polar Perch vom Designstudio PearsonLloyd ist die Kombination zweier Elemente mit weichen, geschwungenen Linien und unterschiedlicher Höhe, die paarweise gruppiert werden und sich gegenseitig ergänzen. Das niedrigere Element ist eine einzelne und eigenständige Sitzbank und kann mit dem höheren Element kombiniert werden, das als Rückenlehne, als eine zweite höhere Sitzbank oder als Ablage fungiert. Das extrem innovative Design dieser kombinierbaren Elemente erlaubt die Gestaltung einzigartiger Formen mit großer ästhetischer Wirkung und das Schaffen personalisierbarer Lösungen für die unterschiedlichsten Anwendungsbereiche.

Fr Ce projet créatif aux visions multiples interprète les besoins d'une vie contemporaine, de plus en plus mobile et multiforme, avec intelligence et originalité. Conçu par PearsonLloyd, Polar Perch est la combinaison de deux éléments aux lignes courbes et douces, de hauteurs différentes, qui composent des paires complémentaires. Alors que l'élément le plus bas, individuel et autonome, assure la fonction d'assise, le plus haut peut y être associé comme dossier ou seconde assise haute, voire comme surface pour poser des objets. Le design hautement innovant de ces éléments modulaires permet de créer des formes inédites d'un grand impact esthétique, offrant des solutions personnalisables en fonction du contexte où il doit s'intégrer.



PearsonLloyd

PearsonLloyd is one of the leading names in contemporary British design, and this multidisciplinary studio works in a wide range of sectors: from furnishing to public spaces to brand development. Established by Luke Pearson and Tom Lloyd in 1997, the studio has received numerous acknowledgements and accolades in both Europe and the United States. The British design duo write regularly for major design magazines, as well as acting as "visiting lecturers" at the École Cantonale d'Art in Lausanne.

Other products by PearsonLloyd:  
Crystal → p.098, Crystal (Armchair) → Vol. B p.108,  
Eddy → Vol. B p.240, Fixie → Vol. B p.252,  
Galleria → p.148, Ischia → p.124, Nebula (Tacchini  
Edizioni), Polar → p.162, Polar Table → Vol. B p.312,  
Quilt → p.062, Stone High/Low → p.180

### Technical informations

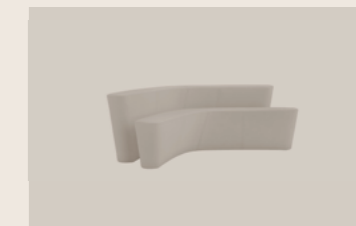

Modular System → p.214

# Stone High/Low

Il fascino delle forme scolpite dalla natura, incredibilmente tradotto in morbide sedute componibili caratterizzate da linee rotonde essenziali e perfettamente armoniose nella creativa progettualità dell'insieme.

Informazioni → p.189



Stone è un sistema di divani pensato in chiave modulare, per disegnare infinite possibilità compositive di grande impatto estetico, dedicate agli spazi pubblici e contract di varie dimensioni. L'immagine delle pietre levigate dall'acqua e dal tempo ha ispirato i designer PearsonLloyd, che ha dato forma a elementi d'arredo che trovano la loro più alta espressione nella modularità della composizione, che lascia spazio alla fantasia, accompagnandola con qualità e funzione. Grazie alla struttura metallica, elegantemente sottile e discreta, disponibile in due diverse altezze, i divani Stone si adattano perfettamente sia a sale d'attesa e spazi relax, che agli ambienti dedicati alla ristorazione, come caffetterie, lounge e ristoranti.

**Designer, Year:**  
PearsonLloyd, 2009

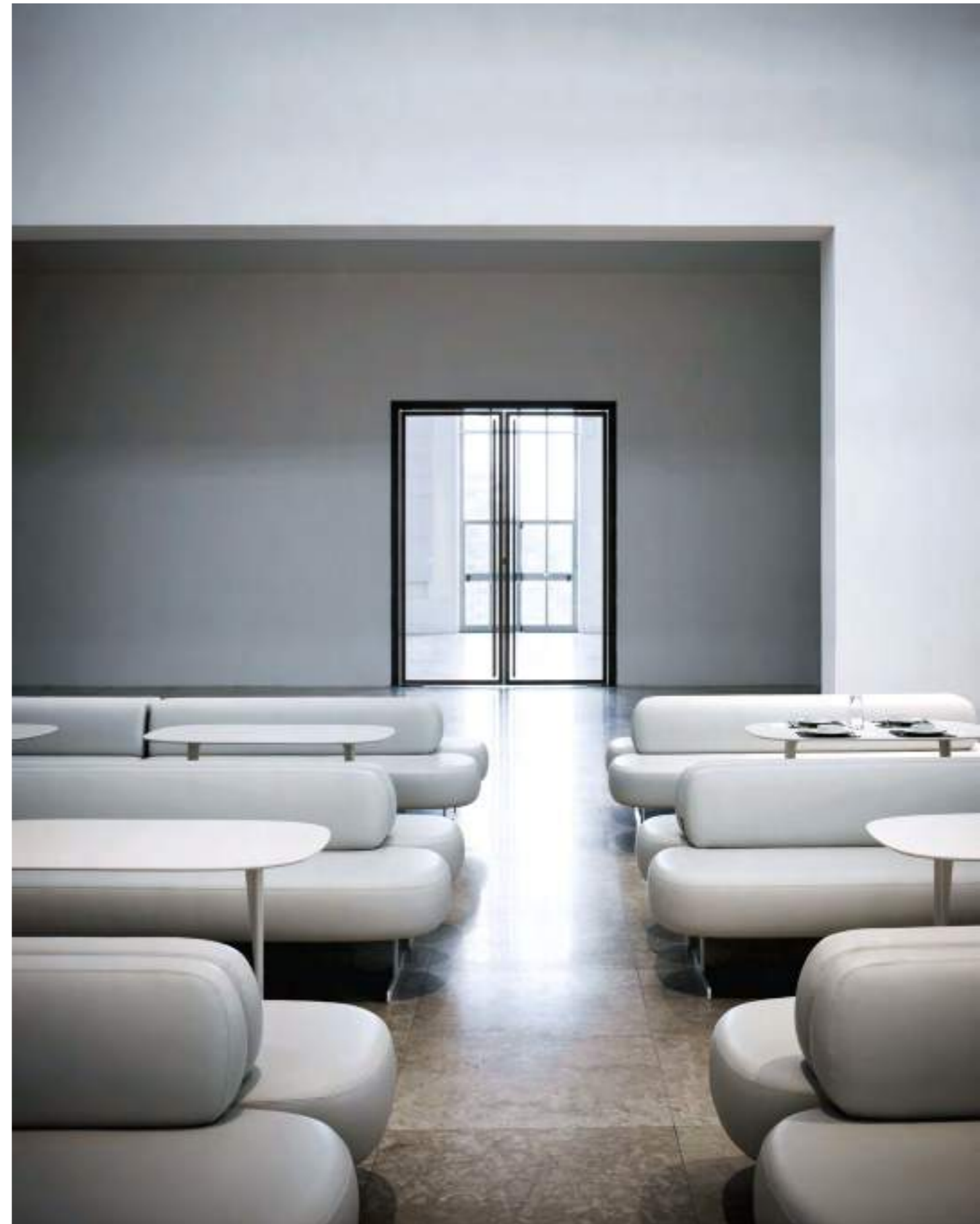

Stone High

Stone High (Modular System), base T02 White  
W 200 D 73 H 77 cm  
H seat 45 cm



Stone High (Modular System), base T07 Black  
W 200 D 73 H 77 cm  
H seat 45 cm



Stone Low (Modular System), base T07 Black  
W 200 D 73 H 68 cm  
H seat 39 cm





## Stone High/Low



Stone Low (Modular System),  
base T02 White  
W 238 D 112 H 68 H seat 39 cm

Polar Table (Low Table),  
finish T22 Yellow ⇒ Vol. B p.312

En The dramatic allure of shapes sculpted by nature, unbelievably transformed into modular seating elements featuring sleek, rounded lines beautifully balanced within the overall creative design concept. Stone is a modular sofa system crafted to unfold infinite possibilities of arrangement with dramatic aesthetic impact, catering to public and contract spaces of all different sizes. The look and feel of stones worn smooth in water over time inspired designer PearsonLloyd, who shaped seating elements that find their highest expression in the modularity of arrangement options that set the imagination free but remain a steadfast ally in terms of quality and functionality. The elegantly slender and discreet metal structure, available in two different heights, ensures the Stone sofas fit perfectly in waiting rooms and leisure spaces, as well as in dining establishments like cafes, lounges and restaurants.

De Die Faszination der von der Natur hervorgebrachten Formen wurde auf einzigartige Weise mit weichen, kombinierbaren Sitzelementen mit minimalistischen runden Linien umgesetzt, die perfekt mit dem kreativen Design des Gesamtbildes harmonisieren. Stone ist ein modulares Sofasystem, das zahllose Gestaltungsmöglichkeiten mit großer ästhetischer Wirkung bietet und für öffentliche Räume und Objekteinrichtungen unterschiedlicher Größe geeignet ist. Das Bild der Steine, die vom Wasser und der Zeit glatt geschliffen worden sind, hat das Designstudio PearsonLloyd dazu inspiriert, Einrichtungselemente zu schaffen, deren Ausdruckskraft durch die Modularität der Kombination zum Tragen kommt. So wird der Phantasie Raum gegeben und die Idee mit Qualität und Funktionalität umgesetzt. Mit ihrem eleganten und diskreten, schmalen Metallgestell, das in zwei Höhen verfügbar ist, passen die Sofas Stone perfekt sowohl in Wartebereiche als auch in Entspannungsbereiche und eignen sich auch für die Gaststättengewerbe, wie Cafeterias, Lounges und Restaurants.

Fr Le charme des formes sculptées par la nature, prodigieusement traduit en sièges moelleux et modulables qui se démarquent par des lignes courbes épurées et parfaitement harmonieuses dans l'élaboration projectuelle de l'ensemble. Stone est un système de canapés conçu dans un esprit modulaire, afin de dessiner des possibilités de composition infinies d'un grand impact esthétique, dédiées aux espaces publics et collectifs de différentes tailles. Le duo PearsonLloyd s'est inspiré de l'image des pierres polies par l'eau et le temps pour donner forme à des éléments d'ameublement qui s'expriment à merveille dans des compositions modulaires laissant libre cours à l'imagination, tout en l'accompagnant avec qualité et fonction. Grâce à la structure métallique, élégamment mince et discrète, disponible en deux hauteurs différentes, les canapés Stone sont parfaitement adaptés à la fois aux salles d'attente et aux espaces de détente, ainsi qu'aux salles dédiées à la restauration, telles que cafétérias, lounge et restaurants.



PearsonLloyd

PearsonLloyd is one of the leading names in contemporary British design, and this multidisciplinary studio works in a wide range of sectors: from furnishing to public spaces to brand development. Established by Luke Pearson and Tom Lloyd in 1997, the studio has received numerous acknowledgements and accolades in both Europe and the United States. The British design duo write regularly for major design magazines, as well as acting as "visiting lecturers" at the École Cantonale d'Art in Lausanne.

Other products by PearsonLloyd:  
Crystal ⇒ p.098, Crystal (Armchair) ⇒ Vol. B p.108,  
Eddy ⇒ Vol. B p.240, Fixie ⇒ Vol. B p.252,  
Galleria ⇒ p.148, Ischia ⇒ p.124, Nebula (Tacchini Edizioni), Polar ⇒ p.162, Polar Perch ⇒ p.170,  
Polar Table ⇒ Vol. B p.312, Quilt ⇒ p.062

### Technical informations



Modular System ⇒ p.214

# Intercity

Intercity è un sistema componibile che permette di creare spazi a misura di qualsiasi ambiente ed esigenza.

Informazioni → p.199



La scelta di moduli base è ampia e comprende elementi imbottiti con o senza schienale, sia lineari che curvi. Le sedute lineari, anche con tavolino integrato in marmo di Carrara opaco o Basaltina, si possono accostare a piacimento per comporre diverse soluzioni, anche le più particolari, come quelle rese possibili dall'elemento con schienale a forma di esse, che crea una seduta bifacciale, o dagli elementi con sedute "face to face". Grazie ai moduli curvi si realizzano anche composizioni ad arco oppure a isola. Completa il sistema di sedute il pouf rotondo, con o senza piano in marmo inserito.

**Designer, Year:**  
Pietro Arosio, (1999) 2018





Intercity (Ottoman), table top  
T30 Matt White Carrara Marble  
Ø 150 H 40 cm



Intercity (Modular System), base T23  
Polished Chrome, feet T03 Grey



Intercity (Modular System), base T23  
Polished Chrome, feet T03 Grey,  
table top T35 Matt Basaltina Marble  
W 180 D 75 H 73 H seat 40 cm



Intercity (Modular System), base T23  
Polished Chrome, feet T03 Grey,  
table top T35 Matt Basaltina Marble  
W 150 D 75 H 73 H seat 40 cm



Intercity (Modular System), base T23  
Polished Chrome, feet T03 Grey,  
table top T30 Matt White Carrara Marble

## Intercity

En Intercity is a modular system for creating spaces tailored to any room and need. The wide choice of base modules includes upholstered elements with or without back, both straight and curved. The straight seats, also with integrated side table in matte Carrara marble or Basaltina, can be combined as preferred to compose different solutions, even the most unusual ones, such as those made possible by the module with S-shaped back which creates a double-sided seat, or by the modules with "face-to-face" seats. Arch or island compositions can be created thanks to the curved modules. The seating system also includes a round pouf, with or without integrated top in marble.

De Intercity ist ein zusammenstellbares Einrichtungssystem, mit dem Räume nach Maß für jedes Ambiente und Bedürfnis gestaltet werden können. Die umfangreiche Auswahl an Grundmodulen enthält gepolsterte Elemente mit oder ohne Rückenlehne, in gerader oder runder Form. Die geraden Sitzmöbel, in die auch Ablagen aus Carrara-Marmor matt oder Basaltina integrierbar sind, können unterschiedliche Lösungen ergeben. Sehr speziell die doppelseitige Zusammenstellung dank Rückenlehne in S-Form, oder die Elemente mit Sitzflächen „face-to-face“. Die runden Module können zu bogenförmigen Kompositionen oder Sitz-Inseln verbunden werden. Ein runder Hocker, mit oder ohne Marmorplatte, komplettiert das Einrichtungssystem.

Fr Intercity est un système modulaire qui permet de créer espaces adaptés à n'importe quel environnement et exigence. Il dispose d'un vaste choix de modules de base et comprend des éléments rembourrés avec ou sans dossier, linéaires ou courbes. Les banquettes linéaires, également avec table basse incorporée en marbre de Carrare mat ou Basaltina, peuvent être juxtaposées à volonté pour créer différentes solutions, même les plus particulières, comme celles rendues possibles par l'élément avec dossier en forme de « S », qui crée une banquette biface, ou par les éléments avec assises vis à vis. Grâce aux modules courbes, il est possible de réaliser également des compositions en arc de cercle ou en îlot. Le système est complété par un pouf rond, avec ou sans plateau en marbre inséré.



Pietro Arosio

Pietro Arosio was born in 1946 in Lissone, near Milan. He learnt his profession at the research centre of a company specialising in the production of metal furniture for communal spaces. This experience led to the emergence of a design philosophy that developed over time through his work as an industrial designer. He began his career in 1972, and was already winning accolades in 1983, receiving the Casaviva d'Oro award. The fundamentals of his work include essentiality, research into new materials and technologies, and attention to detail and to the engineering implications of his designs. Pietro Arosio is fully aware of the emotional impact his products can have, and has worked in partnership with various internationally-acclaimed artists, including Nespolo, Del Pezzo, Hsiao Chin, Tilson, Rotella and Keizo. A number of his pieces have been exhibited at the Victoria and Albert Museum in London, and at the Munich modern art museum Die Sammlung.

Other products by Pietro Arosio:  
Moon ⇨ Vol. B p.144, Parentesi ⇨ Vol. B p.132,  
Quadro ⇨ p.084, Slalom ⇨ Vol. B p.192,  
Sliding ⇨ p.112, XL ⇨ Vol. B p.162

### Technical informations









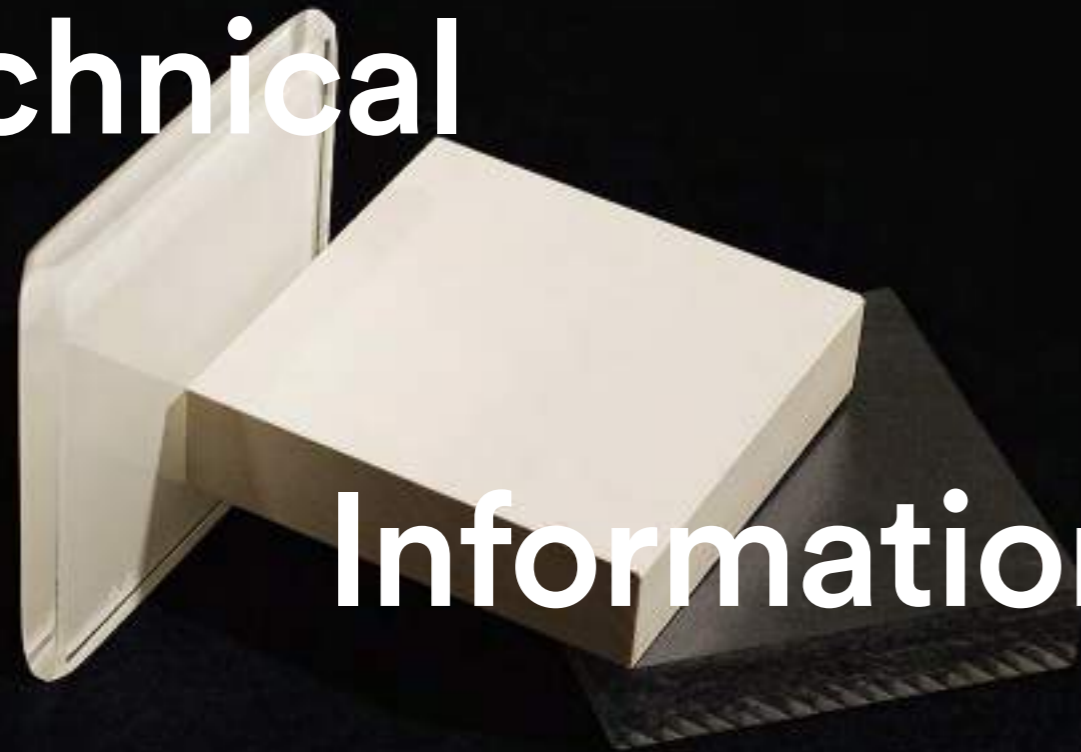



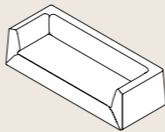
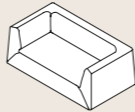

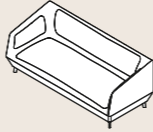
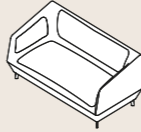



Modular System ⇨ p.210, 211



La collezione e i progetti Tacchini non si fermano alla produzione e ai suoi processi. La storia di questa famiglia, e dell'azienda che ne porta il nome, si intreccia con la storia del design italiano e internazionale: ogni capitolo è stato scritto con cura e attenzione per il dettaglio, e ogni oggetto traduce queste passioni.





# Technical Informations

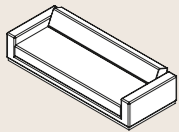
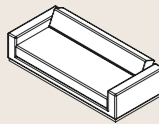

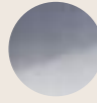
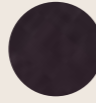

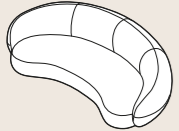
The Tacchini collection and designs are about more than just production and processes. The history of this family, and of the company that bears its name, is interwoven with the history of Italian and international design: each chapter was written with care and attention to detail, and each product reflects this passion.





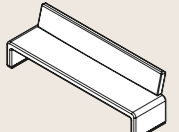
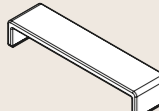
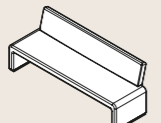
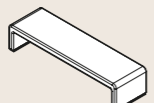
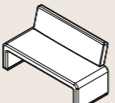
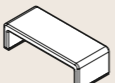



Crystal	by PearsonLloyd			Sofa, Armchair	Non-removable covers
				Base	
OCRY213 W 213 D 85 H 68 cm Seat H 46 cm	OCRY153 W 153 D 85 H 68 cm Seat H 46 cm	OCRY96/OCRYG96 W 96 D 80 H 68 cm Seat H 43 cm		Base fissa (OCRY96) o girevole (OCRYG96) Fixed (OCRY96) or swivel (OCRYG96) base	Mit fixer (OCRY96) oder Drehgestell (OCRYG96) Base fixe (OCRY96) ou pivotante (OCRYG96)
Dressed	by Luca Nichetto			Sofa	Removable covers Not feasible in Super Leather and Aniline Leather
					
ODRES220 W 220 D 88 H 81 cm Seat H 40 cm	ODRES175 W 175 D 88 H 81 cm Seat H 40 cm				
					
	T02 RAL 9016	T07 RAL 9011			
Base verniciata Painted base Gestell lackiert Piétement laqué	Bianco White Weiss Blanc	Nero Black Schwarz Noir	Cerniera Zip Reißverschluss Fermeture éclair	Bianco White Weiss Blanc	Nero Black Schwarz Noir
Face to Face	by Gordon Guillaumier			Sofa	Non-removable covers
					
OFAC196 W 196 D 97 H 73,5 cm Seat H 38 cm					
					
	T02 RAL 9016	T03 RAL 7016	T25	T27	
Base verniciata Painted base Gestell lackiert Piétement laqué	Bianco White Weiss Blanc	Grigio Grey Grau Gris	Base cromata Chromed base Gestell verchromt Piétement chromé	Oro Champagne Opaco Matt Champagne Gold Matt Champagne Gold Or Champagne Mat	Cromo Nero Opaco Matt Black Chromed Matt Schwarz Verchromt Chrome Noir Mat
					
	T77	T78	T79	T80	T81 T82
Cucitura punto croce: colore filati Cross-stitched seam: yarn color					

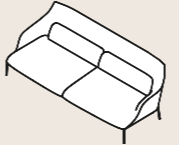





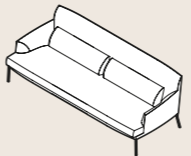
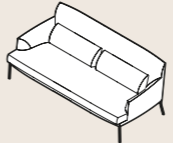
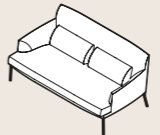

Havana	by Lievore Altherr Molina		Sofa, Sofa Bed	Removable covers
				
OHAV255 W 255 D 102 H 69 cm Seat H 38 cm	OHAV225 W 225 D 102 H 69 cm Seat H 38 cm			
				
Base Base Gestell Piétement	Alluminio Aluminium Aluminium Aluminium	Alluminio Lucido Gloss Aluminium Aluminium Glänzend Aluminium Brillant	Wengè Wengè Wengè Wengè	

Julep	by Jonas Wagell		Sofa, Armchair, Ottoman, Chaise-longue	Non-removable covers
				
OJUL240 W 240 D 126 H 75 cm Seat H 42 cm	OJUL102 W 102,5 D 87,5 H 75 cm Seat H 42 cm	OJULP68 W 68 D 66 H 42 cm Seat H 42 cm	OJUL174 W 174 D 137 H 75 cm Seat H 42 cm	

Labanca	by Lievore Altherr Molina		Sofa, Armchair	Non-removable covers	
					
OLABD240 W 240 D 62 H 74 cm Seat H 39,5 cm	OLABP240 W 240 D 62 H 39,5 cm Seat H 39,5 cm	OLABC200 W 200 D 62 H 74 cm Seat H 39,5 cm	OLABP200 W 200 D 62 H 39,5 cm Seat H 39,5 cm	OLABB140 W 140 D 62 H 74 cm Seat H 39,5 cm	OLABP140 W 140 D 62 H 39,5 cm Seat H 39,5 cm



				
OLABA80 W 80 D 62 H 74 cm Seat H 39,5 cm	OLABP80 W 80 D 62 H 39,5 cm Seat H 39,5 cm			

Lima	by Claesson Koivisto Rune			Sofa, Armchair, Ottoman	Non-removable covers
					
OLIM213 W 218 D 91 H 78,5 cm Seat H 39,5 cm	OLIM183 W 188 D 91 H 78,5 cm Seat H 39,5 cm	OLIM153 W 158 D 91 H 78,5 cm Seat H 39,5 cm	OLIM89 W 89 D 91 H 78,5 cm Seat H 39,5 cm	OLIM70 W 89 D 70 H 39,5 cm Seat H 39,5 cm	
					
Base verniciata Painted base Gestell lackiert Piétement laqué	Bianco White Weiss Blanc	Nero Black Schwarz Noir	Marrone Brown Braun Brun		

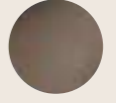

Montevideo	by Claesson Koivisto Rune			Sofa, Armchair, Ottoman, Chair	Removable covers
					
OMON222 W 222 D 90 H 78 cm Seat H 40 cm	OMON192 W 192 D 90 H 78 cm Seat H 40 cm	OMON162 W 162 D 90 H 78 cm Seat H 40 cm	OMON96 W 96 D 90 H 78 cm Seat H 40 cm	OMON93 W 93 D 71 H 40 cm Seat H 40 cm	OMON54 W 54 D 62 H 80 cm Seat H 47 cm
					
Base verniciata Painted base Gestell lackiert Piétement laqué	Bianco White Weiss Blanc	Nero Black Schwarz Noir	Marrone Brown Braun Brun	Metalgrey Metalgrey Metalgrey Metalgrey	Bronzo Bronze Bronze Bronze

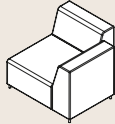
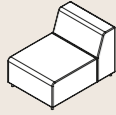
Oliver	by Gianfranco Frattini		Sofa	Design Classic	Non-removable covers
					
OOLIV190 W 190 D 83,5 H 77 cm Seat H 40 cm					
					
Base verniciata Painted base Gestell lackiert Piétement laqué	Bianco White Weiss Blanc	Nero Black Schwarz Noir		Cromo Nero Opaco Matt Black Chromed Matt Schwarz Verchromt Chrome Noir Mat	

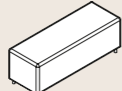

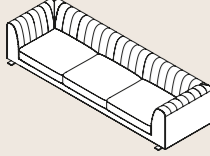
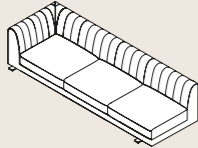
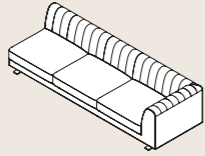
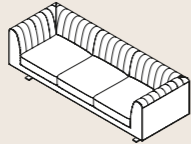
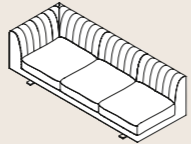

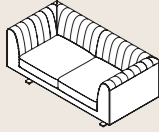
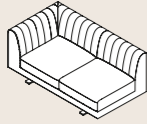
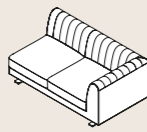
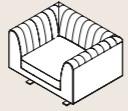

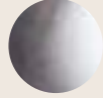

<b>Quadro</b>	<b>by Pietro Arosio</b>		<b>Sofa, Armchair, Ottoman</b>	<b>Removable covers</b>
				
<b>OQA100</b> W 98 D 98 H 66 cm Seat H 36 cm	<b>OQB70</b> W 70 D 98 H 66 cm Seat H 36 cm	<b>OQD70</b> W 70 D 70 H 36 cm Seat H 36 cm	<b>OQE35</b> W 98 D 35 H 36 cm Seat H 36 cm	

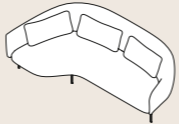
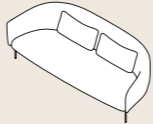

<b>Quilt</b>	<b>by Pearson Lloyd</b>		<b>Sofa, Armchair, Ottoman</b>	<b>Removable covers</b>
				
<b>OQUI260</b> W 260 D 80 H 68 cm Seat H 41 cm	<b>OQUM240</b> W 240 D 80 H 68 cm Seat H 41 cm	<b>OQUL240</b> W 240 D 80 H 68 cm Seat H 41 cm	<b>OQUF220</b> W 220 D 80 H 68 cm Seat H 41 cm	<b>OQUH200</b> W 200 D 80 H 68 cm Seat H 41 cm

				
<b>OQUC160</b> W 160 D 80 H 68 cm Seat H 41 cm	<b>OQUE140</b> W 140 D 80 H 68 cm Seat H 41 cm	<b>OQUD140</b> W 140 D 80 H 68 cm Seat H 41 cm	<b>OQUB100</b> W 100 D 80 H 68 cm Seat H 41 cm	<b>OQUN80</b> W 80 D 80 H 41 cm Seat H 41 cm

				
	<b>T03</b> <b>RAL 7016</b>	<b>T23</b>		
<b>Base</b> Base Gestell Piétement	<b>Grigio</b> Grey Grau Gris	<b>Cromo Lucido</b> Polished Chromed Poliert Verchromt Chrome Brillant		

<b>Roma</b>	<b>by Jonas Wagell</b>		<b>Sofa, Armchair</b>	<b>Non-removable covers</b>
				
<b>OROM234</b> W 234,5 D 121,4/84 cm H 73,5 Seat H 38,5 cm	<b>OROM230</b> W 233 D 92 H 73,5 cm H seat 38,5 cm	<b>OROM106</b> W 106,3 D 88,5 H 73,5 cm Seat H 38,5 cm		

				
	<b>T02</b> <b>RAL 9016</b>	<b>T07</b> <b>RAL 9011</b>	<b>T24</b>	<b>T25</b>
<b>Base verniciata</b> Painted base Gestell lackiert Piétement laqué	<b>Bianco</b> White Weiss Blanc	<b>Nero</b> Black Schwarz Noir	<b>Base cromata</b> Chromed base Gestell verchromt Piétement chromé	<b>Cromo Satinato</b> Satin Chrome Satinert Verchromt Chrome Satiné

<b>Santiago</b>	<b>by Claesson Koivisto Rune</b>		<b>Sofa, Armchair, Ottoman</b>	<b>Non-removable covers</b>
				
<b>OSANT164</b> W 164 D 88 H 85 cm Seat H 41 cm	<b>OSANT96</b> W 96 D 88 H 85 cm Seat H 41 cm	<b>OSANT93</b> W 93 D 71 H 40 cm Seat H 40 cm		

				
	<b>T02</b> <b>RAL 9016</b>	<b>T03</b> <b>RAL 7016</b>	<b>T07</b> <b>RAL 9011</b>	<b>T44</b>
<b>Piedini</b> Feet FüÙe Pieds	<b>Bianco</b> White Weiss Blanc	<b>Grigio</b> Grey Grau Gris	<b>Nero</b> Black Schwarz Noir	<b>Tinto Noce Chiaro</b> Light Walnut Licht Walnuss Noyer Clair

<b>Sella</b>	<b>by Carlo De Carli</b>		<b>Sofa, Armchair</b>	<b>Design Classic</b>	<b>Non-removable covers</b>
					
<b>OSEL222</b> W 222 D 97 H 83 cm H seat 42 cm	<b>OSEL102</b> W 102 D 97 H 83 cm H seat 42 cm				

Sesann	by Gianfranco Frattini		Sofa, Armchair	Design Classic	Non-removable covers
OSES240 W 240 D 94 H 67 cm Seat H 38 cm	OSES180 W 180 D 94 H 67 cm Seat H 38 cm	OSES110 W 110 D 94 H 67 cm Seat H 38 cm			
	T02 RAL 9016	T07 RAL 9011	T11 RAL 2011	T61 RAL 6014	
Struttura Structure Gestell Piétement	Bianco White Weiss Blanc	Nero Black Schwarz Noir	Arancio Orange Orange Orange	Verde Scuro Dark Green Dunkelgrün Vert Foncé	
T23	T24	T25	T27	T28	T64
Cromo Lucido Polished Chromed Poliert Verchromt Chrome Brillant	Cromo Satinato Satin Chrome Satiniert Verchromt Chrome Satiné	Oro Champagne Opaco Matt Champagne Gold Matt Champagne Gold Or Champagne Mat	Cromo Nero Opaco Matt Black Chromed Matt Schwarz Verchromt Chrome Noir Mat	Cromo Nero Lucido Polished Black Chromed Schwarz-Glänzend Chrome Noir Brillant	Rame Spazzolato Opaco Brush Matt Copper Matt Gebürstet Kupfer Brossé Mat Cuivre
	T43	T49			
Piedini Feet Füßen Patins	Noce Scuro Dark Walnut Dunkel Walnuss Noyer Foncé	Tinto Grigio Grey Grau Gris			

Sliding	by Pietro Arosio		Sofa, Sofa Bed	Removable covers
OINGV200 W 204 D 100 H 83 cm Seat H 42 cm	W 204 D 144 H 42 cm Seat H 42 cm	Brevettato Patented		
	T07 RAL 9011	T03 RAL 7016	T03 RAL 7016	
Base Base Gestell Piétement	Alluminio Aluminium Aluminium Aluminium	Piedino Nero Black Feet Füße Schwarz Pieds Noir	Base Base Gestell Piétement	Grigio Grey Grau Gris
	T03 RAL 7016	T03 RAL 7016	T03 RAL 7016	T03 RAL 7016
	T03 RAL 7016	T03 RAL 7016	T03 RAL 7016	T03 RAL 7016
	T03 RAL 7016	T03 RAL 7016	T03 RAL 7016	T03 RAL 7016
	T03 RAL 7016	T03 RAL 7016	T03 RAL 7016	T03 RAL 7016





Chill-Out	by Gordon Guillaumier		Modular System	Non-removable covers	
OCHILP70 W 74 D 69 H 71 cm Seat H 44 cm	OCHILQ70 W 74 D 69 H 71 cm Seat H 44 cm	OCHILR70 W 74 D 69 H 71 cm Seat H 44 cm	OCHILI70 W 74 D 69 H 44 cm Seat H 44 cm	OCHILL141 W 144 D 69 H 71 cm Seat H 44 cm	OCHILM141 W 144 D 69 H 71 cm Seat H 44 cm
OCHILN141 W 144 D 69 H 71 cm Seat H 44 cm	OCHILH141 W 144 D 69 H 44 cm Seat H 44 cm	OCHILO141 W 144 D 69 H 71 cm Seat H 44 cm	OCHILG141 W 144 D 69 H 44 cm Seat H 44 cm	OCHILD212 W 214 D 69 H 71 cm Seat H 44 cm	OCHILS212 W 214 D 69 H 71 cm Seat H 44 cm
OCHILE212 W 214 D 69 H 71 cm Seat H 44 cm	OCHILA212 W 214 D 69 H 44 cm Seat H 44 cm	OCHILF212 W 214 D 69 H 71 cm Seat H 44 cm	OCHILB212 W 214 D 69 H 44 cm Seat H 44 cm	OCHILC212 W 214 D 69 H 44 cm Seat H 44 cm	
1CHIL70 W 72 D 67 H 38,5 cm	1CHIL140 W 142 D 67 H 38,5 cm				

Chill-Out High Back/Arms	by Gordon Guillaumier		Modular System	Non-removable covers	
OCHILP70H W 74 D 69 H 71 cm Seat H 44 cm	OCHILQ70H L74 D 69 H 71 cm Seat H 44 cm	OCHILL141H L144 D 69 H 71 cm Seat H 44 cm	OCHILM141H L144 D 69 H 71 cm Seat H 44 cm	OCHILO141H L144 D 69 H 71 cm Seat H 44 cm	OCHILD212H W 214 D 69 H 71 cm Seat H 44 cm
OCHILS212H W 214 D 69 H 71 cm Seat H 44 cm	OCHILF212H W 214 D 69 H 71 cm Seat H 44 cm				

Chill-Out High	by Gordon Guillaumier		Modular System		Non-removable covers
OCHILHQ70 L74 D 69 H 121 cm Seat H 44 cm	OCHILHO141 L144 D 69 H 121 cm Seat H 44 cm	OCHILT141 L144 D 69 H 121 cm Desk H 70 cm	OCHILHL141 L144 D 69 H 121 cm Seat H 44 cm	OCHILHN141 W 144 D 69 H 121 cm Seat H 44 cm	OCHILHM141 L144 D 69 H 121 cm Seat H 44 cm
				<p>OCHILHS212 OCHILHM141 OCHILHQ70</p> <p>Bracciolo destro o sinistro guardando il prodotto frontalmente. Right or left armrest when in front of the item.</p> <p>OCHILHF212 OCHILHO141</p> <p>Tavolino destro o sinistro guardando il prodotto frontalmente. Right or left tablet when in front of the item.</p>	
OCHILHF212 W 214 D 69 H 121 cm Seat H 44 cm	OCHILHE212 W 214 D 69 H 121 cm Seat H 44 cm	OCHILHS212 W 214 D 69 H 121 cm Seat H 44 cm	OCHILHD212 W 214 D 69 H 121 cm Seat H 44 cm		
	T02	T03	T24	T25	T64
Base Base Gestell Piétement	Bianco White Weiss Blanc	Grigio Grey Grau Gris	Cromo Satinato Satin Chromed Satinier Verchromt Chrome Satiné	Oro Champagne Opaco Matt Champagne Gold Matt Champagne Gold Or Champagne Mat	Rame Spazzolato Opaco Brush Matt Copper Matt Gebürstet Kupfer Brossé Mat Cuivre
	T30	T31	T33	T35	
Piano Top Tischplatte Plateau	Carrara Opaco Matt White Carrara Matt Carrara Carrara Mat	Calacatta Lucido Shiny White Calacatta Calacatta Glänzend Calacatta Brillant	Black Travertino Opaco Matt Black Travertine Matt Schwarz Travertino Noir Travertino Mat	Basaltina Opaco Matt Basaltina Matt Basaltina Basaltina Mat	

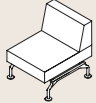
Galleria	by PearsonLloyd		Modular System		Non-removable covers
OGALA250 W 250 D 250 H 42 cm Seat H 42 cm	OGALB250 W 250 D 250 H 42 cm Seat H 42 cm	OGALC250 W 250 D 250 H 42 cm Seat H 42 cm	OGALD300 W 300 D 98 H 42 cm Seat H 42 cm		
OGALSH400 W 400 D 98 H 42 cm Seat H 42 cm	OGALSI300 W 300 D 49 H 42 cm Seat H 42 cm	OGALSS400 W 400 D 250 H 42 cm Seat H 42 cm			
1GALTM Ø 40 H 10 cm	1GALTL Ø 40 H 52 cm	OGALC49 49 x 49 cm	OGALC99 49 x 99 cm	OGALP W 100 D 18 H 34 cm	1GALT Ø 40,5 cm H 9,5 cm
Piano legno Wooden top Holzplatte Plateau en bois	Naturale Natural Naturel	Tinto Grigio Grey Grau Gris	Base verniciata Painted base Gestell lackiert Piétement laqué	Bianco White Weiss Blanc	Grigio Grey Grau Gris
	T45	T49		T02	T03
	T02	T03		T30	
Tavolino metallo Little metal table Metalltisch Table en métal	Bianco White Weiss Blanc	Grigio Grey Grau Gris	Tavolino marmo Little marble table Marmortisch Table de marbre	Carrara Opaco Matt White Carrara Matt Carrara Carrara Mat	

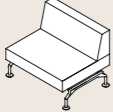
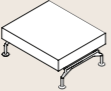
Intercity by Pietro Arosio Modular System Non-removable covers

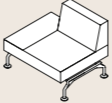
					
OINA60 W 60 D 75 H 73 cm Seat H 40 cm	OINAP60 W 60 D 75 H 40 cm Seat H 40 cm	OINB90 W 90 D 75 H 73 cm Seat H 40 cm	OINBP90 W 90 D 75 H 40 cm Seat H 40 cm	OINB390 W 90 D 75 H 73 cm Seat H 40 cm	OINB490 W 90 D 75 H 73 cm Seat H 40 cm

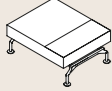
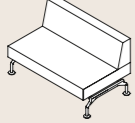
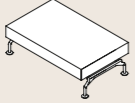
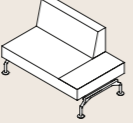
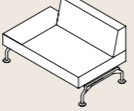
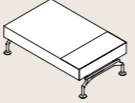
					
OINB190 W 90 D 75 H 40 cm Seat H 40 cm	OINC120 W 120 D 75 H 73 cm Seat H 40 cm	OINCP120 W 120 D 75 H 40 cm Seat H 40 cm	OINC3120 W 120 D 75 H 73 cm Seat H 40 cm	OINC4120 W 120 D 75 H 73 cm Seat H 40 cm	OINC1120 W 120 D 75 H 40 cm Seat H 40 cm

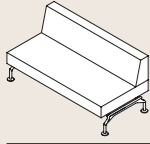
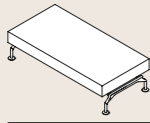
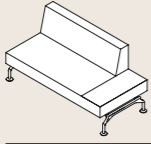
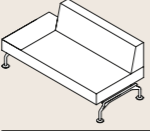
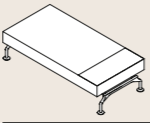
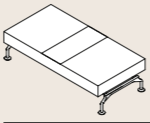

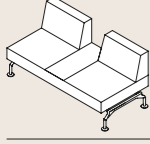
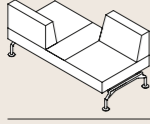
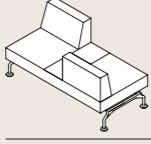
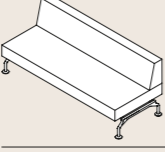
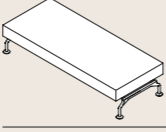
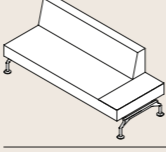
					
OIND150 W 150 D 75 H 73 cm Seat H 40 cm	OINDP150 W 150 D 75 H 40 cm Seat H 40 cm	OIND3150 W 150 D 75 H 73 cm Seat H 40 cm	OIND4150 W 150 D 75 H 73 cm Seat H 40 cm	OIND1150 W 150 D 75 H 40 cm Seat H 40 cm	OIND2150 W 150 D 75 H 40 cm Seat H 40 cm

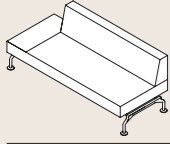
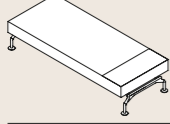
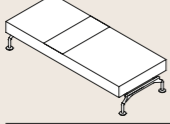
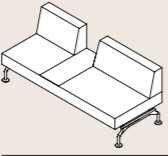
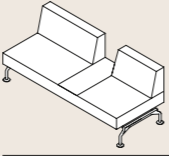
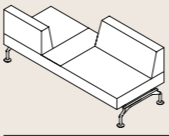
					
OIND5150 W 150 D 75 H 73 cm Seat H 40 cm	OIND6150 W 150 D 75 H 73 cm Seat H 40 cm	OIND7150 W 150 D 75 H 73 cm Seat H 40 cm	OINO180 W 180 D 75 H 73 cm Seat H 40 cm	OINOP180 W 180 D 75 H 40 cm Seat H 40 cm	OINO3180 W 180 D 75 H 73 cm Seat H 40 cm

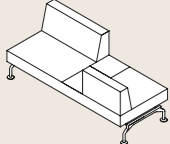
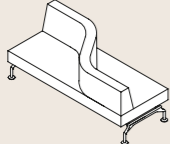
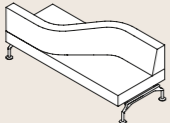
					
OINO4180 W 180 D 75 H 73 cm Seat H 40 cm	OINO1180 W 180 D 75 H 40 cm Seat H 40 cm	OINO2180 W 180 D 75 H 40 cm Seat H 40 cm	OINO5180DX W 180 D 75 H 73 cm Seat H 40 cm	OINO5180SX W 180 D 75 H 73 cm Seat H 40 cm	OINO6180 W 180 D 75 H 73 cm Seat H 40 cm



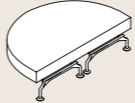
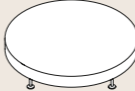
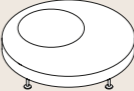





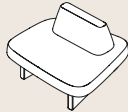
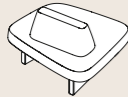
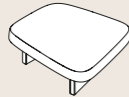
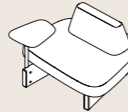
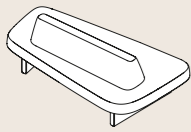
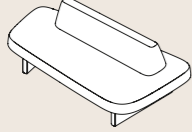
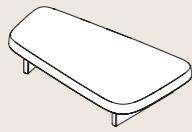
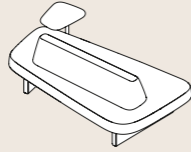
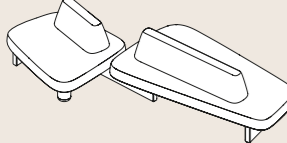
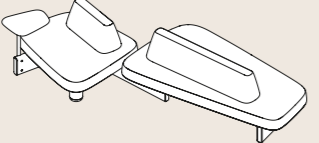
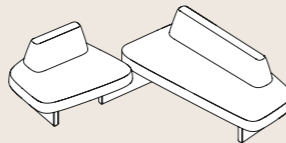
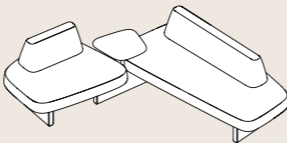
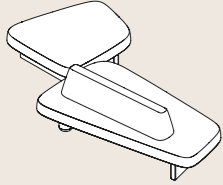
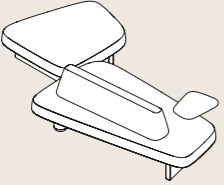
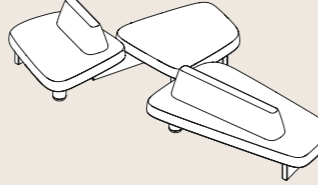
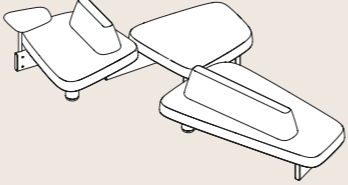

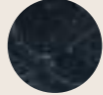
					
OINO7180 W 180 D 75 H 73 cm Seat H 40 cm	OINR180 W 180 D 75 H 73 cm Seat H 40 cm	OINS180 W 180 D 75 H 73 cm Seat H 40 cm			



Intercity by Pietro Arosio Modular System Non-removable covers







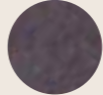



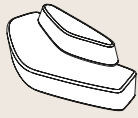

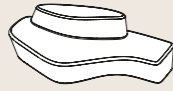

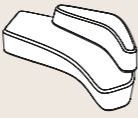
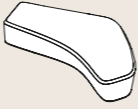
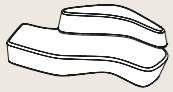

					
OINU151 W 151 D 89,5 H 73 cm Seat H 40 cm	OINUP151 W 151 D 89,5 H 40 cm Seat H 40 cm	OINP150 Ø 150 H 40 cm Seat H 40 cm	OINPT150 Ø 150 H 40 cm Seat H 40 cm	OINBR W 55 D 22 H 10,5 cm	

					
Piano Top Tischplatte Plateau	T30 Carrara Opaco Matt White Carrara Matt Carrara Carrara Mat	T35 Basaltina Opaco Matt Basaltina Matt Basaltina Basaltina Mat			

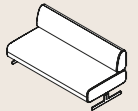
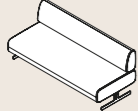
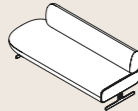
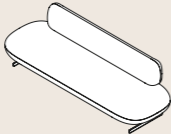
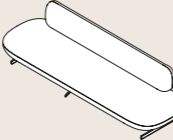
Ischia	by PearsonLloyd	Modular System	Non-removable covers
			
OISCH1C W 119,3 D 103,8 H 75,5 cm Seat H 43 cm	OISCH1L W 119,3 D 103,8 H 75,5 cm Seat H 43 cm	OISCH1P W 119,3 D 103,8 H 75,5 cm Seat H 43 cm	OISCH1CT W 119,3 D 117,8 H 75,5 cm Seat H 43 cm
			
OISCH2C W 199,2 D 103,8 H 75,5 cm Seat H 43 cm	OISCH2L W 199,2 D 103,8 H 75,5 cm Seat H 43 cm	OISCH2P W 199,2 D 103,8 H 75,5 cm Seat H 43 cm	OISCH2CT W 199,2 D 112,4 H 75,5 cm Seat H 43 cm
			
OISCHTA W 316,1 D 173,5 H 75,5 cm Seat H 43 cm	OISCHTAT W 316,1 D 173,5 H 75,5 cm Seat H 43 cm	OISCHTB W 262,2 D 233,3 H 75,5 cm Seat H 43 cm	OISCHTBT W 262,2 D 233,3 H 75,5 cm Seat H 43 cm
			
OISCHTC W 306,5 D 180,5 H 75,5 cm Seat H 43 cm	OISCHTCT W 306,5 D 180,5 H 75,5 cm Seat H 43 cm	OISCHTE W 397,1 D 222,1 H 75,5 cm Seat H 43 cm	OISCHTET W 397,1 D 222,1 H 75,5 cm Seat H 43 cm

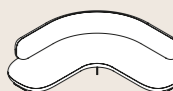
Ischia	by PearsonLloyd	Modular System	Non-removable covers
			
	T30	T32	T45
Piedini Feet Füße Pieds	Carrara Opaco Matt White Carrara Matt Carrara Carrara Mat	Marquinia Lucido Shiny Black Marquinia Schwarz Marquinia Glänzend Noir Marquinia Brillant	Base Base Gestell Piétement
			
	T02	T03	T30
Base tavolino Top base Tisch Basement table	Bianco White Weiss Blanc	Grigio Grey Gru Gris	Carrara Opaco Matt White Carrara Matt Carrara Carrara Mat
			
	T83	T84	T85
Cucitura punto cavallo: colore filati Blanket stitch seam: yarn color			
	T86	T87	T88

Ischia	by PearsonLloyd	Screen
		
OISCP W 135,5 D 45 H 136,9 cm		
		
	T45	T49
Cornice Frame Rahmen Cadre	Naturale Natural Natural Naturel	Tinto Grigio Grey Gru Gris
		
	Paglia di Vienna Cane Webbing Wiener Geflecht Cannage Paille de Vienne	

Polar	by PearsonLloyd		Modular System, Armchair, Ottoman		Non-removable covers
					
OPOLA234 W 234 D 107 H 73 cm Seat H 37 cm	OPOLAP234 W 234 D 107 H 37 cm Seat H 37 cm	OPOLB234 W 234 D 107 H 73 cm Seat H 37 cm	OPOLBP234 W 234 D 107 H 37 cm Seat H 37 cm	OPOLC234 W 234 D 107 H 73 cm Seat H 37 cm	OPOLCP234 W 234 D 107 H 37 cm Seat H 37 cm
					
OPOLD234 W 234 D 107 H 73 cm Seat H 37 cm	OPOLDP234 W 234 D 107 H 37 cm Seat H 37 cm	OPOL107 W 107 D 81,5 H 67 cm Seat H 37 cm	OPOLP107 W 107 D 81,5 H 37 cm Seat H 37 cm		
Polar Perch	by PearsonLloyd		Modular System		Non-removable covers
					
OPER220 W 220 D 79 H 70 cm Seat H 70 cm	OPER207 W 207 D 84,5 H 46 cm Seat H 46 cm				
Stone Low/High	by PearsonLloyd		Modular System		Non-removable covers
					
OSTAB150/OSTAA150 W 150 D 73 H 68/77 cm Seat H 39/45 cm	OSTBB170/OSTBA170 W 170 D 73 H 68/77 cm Seat H 39/45 cm	OSTCB190/OSTCA190 W 190 D 73 H 68/77 cm Seat H 39/45 cm	OSTDB200/OSTDA200 W 200 D 73 H 68/77 cm Seat H 39/45 cm	OSTEB230/OSTEA230 W 230 D 73 H 68/77 cm Seat H 39/45 cm	OSTFB90/OSTFA90 W 144 D 100 H 68/77 cm Seat H 39/45 cm
					
OSTGB120/OSTGA120 W 238 D 112 H 68/77 cm Seat H 39/45 cm	OSTHB90/OSTHA90 W 250 D 134 H 68/77 cm Seat H 39/45 cm				
					
	T02	T07		T24	
Base verniciata Painted base Gestell lackiert Piétement laqué	Bianco White Weiss Blanc	Nero Black Schwarz Noir	Base cromata Chromed base Gestell verchromt Piétement chromé	Cromo Satinato Satin Chromed Satiniert Verchromt Chrome Satiné	

# Qualità

La collezione e i progetti Tacchini non si fermano alla produzione e ai suoi processi. La storia di questa famiglia, e dell'azienda che ne porta il nome, si intreccia con la storia del design italiano e internazionale: ogni capitolo è stato scritto con cura e attenzione per il dettaglio, e ogni oggetto traduce queste passioni. E ancora, Tacchini vuole rivelare, dalle segrete stanze del suo fare, i modi e i metodi con cui si trattano i materiali, l'attenzione con cui si curano le superfici e se ne preservano la qualità estetiche, i segreti e le virtù delle tecnologie impiegate per trattarli, dall'esperienza del passato all'innovazione della ricerca.

## Tacchini per l'Ambiente

Da anni, Tacchini ha implementato la sua attenzione per l'ambiente, in linea con la normativa UNI EN ISO 14001:2004. Ogni fase del processo produttivo è oggetto di controlli rigorosi: dal progetto alla realizzazione, coinvolgendo ogni dipartimento, ogni collaboratore e ogni fornitore. Fino al cliente. Ognuno dei pezzi Tacchini è realizzato secondo gli standard internazionali più severi, in ambienti di lavoro di assoluto comfort, con l'impiego di materiali italiani, di provenienza certificata. Tutte le lavorazioni sono studiate nell'assoluto rispetto dell'ambiente: riducendo al minimo lo spreco di materiale e i livelli di emissioni. Tutto questo, permette che ogni prodotto Tacchini sia parzialmente riciclabile.

## Tacchini per la Qualità

L'attenzione per la qualità comincia dalla scelta dei materiali, già capaci di trasmettere forti emozioni, e esaltati dalla cura del dettaglio e dall'innovazione tecnologica: percepibile poi in ogni pezzo o spazio progettati da Tacchini. La qualità del prodotto, risultato sinergico tra tradizione, progresso e immaginazione progettuale, diventa poi qualità del servizio: sia nei processi commerciali che di post vendita.

## Tacchini per l'Italia

La creatività senza limiti o confini, la tradizione nel mondo dell'arredamento, patrimonio dei padri fondatori, capaci di trasmettere valori unici alle generazioni successive, il progresso tecnologico sempre aggiornato, rendono unico ogni prodotto: e tutti i pezzi della collezione Tacchini sono realizzati in Italia. Esempio autentico di Made in Italy.

The Tacchini collection and designs are about more than just production and processes. The history of this family, and of the company that bears its name, is interwoven with the history of Italian and international design: each chapter was written with care and attention to detail, and each product reflects this passion. From the secret rooms where its work is done, Tacchini wants to reveal the means and methods used to prepare the materials, the care with which it treats its surfaces, safeguarding their fine appearance, the secrets and virtues of the technologies used to treat them, from the experience of the past to modern research and innovation.

## Tacchini for the Environment

For years, Tacchini has paid careful attention to the environment, adhering to standard UNI EN ISO 14001:2004. Each phase of the production process is subject to strict controls, from design to manufacture, involving every department, every staff member and every supplier. Right through to the customer. Each Tacchini piece is produced according to exacting international standards, in working environments offering excellent standards of comfort, and using Italian materials from certified sources. All processes are developed to ensure absolute respect for the environment, reducing waste material and emission levels to the minimum. These measures mean that every Tacchini product can be partially recycled.

## Tacchini for Quality

Attention to quality begins with the choice of materials, which in themselves can convey strong sensations, and are further enhanced by the regard for detail and by technological innovations, which are noticeable in every piece and every space designed by Tacchini. Product quality is the fruit of a synergy between tradition, progress and imaginative design, and is then reflected in service quality, both during the sales process and post-sales.

## Tacchini for Italy

Our creativity knows no bounds. The furniture-making tradition handed down from our founding fathers who knowingly conveyed unique values to the new generations, our constant position on the leading edge of technological progress: these factors make each product unique, and all pieces in the Tacchini collection are made in Italy. A genuine example of Italian-made quality.

Tacchini si impegna concretamente per il rispetto dell'ambiente, lo sviluppo sostenibile ed il consumo intelligente. La qualità dei materiali e della realizzazione garantisce una lunga vita dei prodotti, riducendo il consumo di energia, le emissioni in atmosfera e l'impatto ambientale al termine del loro utilizzo. W'azienda utilizza legni provenienti da coltivazioni a ricrescita controllata, privilegia l'impiego di materiali riciclabili e riduce al massimo gli sprechi in fase di produzione e imballo.

Tacchini is concretely committed to environment respect, sustainable development and clever consumption. Materials and manufacturing quality guarantees long lasting products, reducing energy consumption, emissions into the atmosphere and environmental impact when their use is over. The company uses wood from sustainable cultivations, favours recyclable materials and highly reduces waste during both production and packing steps.

Tacchini T'20  
Objects, Stories

Graphic design:  
Think Work Observe

Photography:  
Andrea Ferrari

Styling:  
Maria Gabriella Zecca

Copy editing:  
Gaia De Santis  
Massimiliano  
Di Bartolomeo

Post production:  
Erica Fadini

Color separation  
and printing:  
Nava

Copyright © 2020 Tacchini  
Italia Forniture Srl  
All rights reserved. No part  
of this publication may be  
reproduced or transmitted in  
any form or by any means,  
electronic or mechanical,  
without prior permission of  
the owner. All copyrights and  
intellectual property rights,  
including trademarks, patents  
and copyrights, remain the  
property of Tacchini Italia  
Forniture Srl and are explicitly  
reserved.

Acknowledgments:  
Artemide  
Astep  
Bitossi Home  
cc tapis  
Flos  
Fontana Arte  
Ghidini 1961  
Incipit Lab  
Martinelli Luce  
Nemo Lighting  
Nodus  
Orsjo  
Penta Light  
Stelton  
Wastberg  
Zero Lighting

Tacchini Italia Forniture Srl

19, via Domodossola  
20822 Baruccana di Seveso  
(Monza Brianza) Italy  
T: +39 0362 50 41 82  
E-mail: info@tacchini.it  
www.tacchini.it

