

SHAPES OF LIGHT

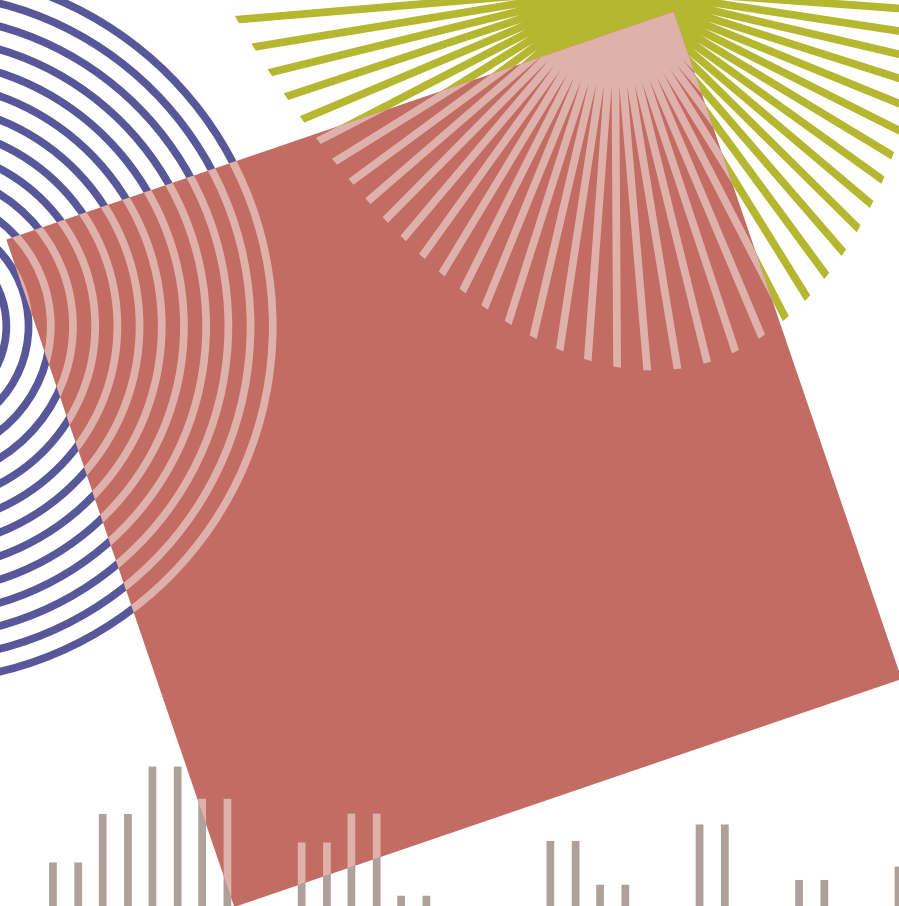

news 2019



SHAPES OF LIGHT

Indice

Indoor

Outdoor

Sospensione/
Pendant lamp

Plafoniera/
Ceiling lamp

Parete/
Wall lamp

Tavolo/
Table lamp

Terra/
Floor lamp

Comfort acustico/
Sound-absorbing



DESIGN

4

CHANDELIER
CHANDELIER LOUNGE

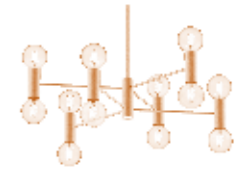

16

CHARLIE



24

GECO



30

NUCLEO



ENJOY THE SILENCE

36

IDEA





CHANDELIER

In equilibrio tra passato e presente, Chandelier interpreta in chiave contemporanea le suggestioni del lampadario a bracci della tradizione veneziana. Aste e cilindri danno vita a un gioco visivo ispirato al linguaggio essenziale del design razionalista.

Balanced between past and present, Chandelier gives a contemporary reinterpretation of traditional Venetian chandeliers. Rods and cylinders create a visual interplay inspired by the essential design codes of rationalism.



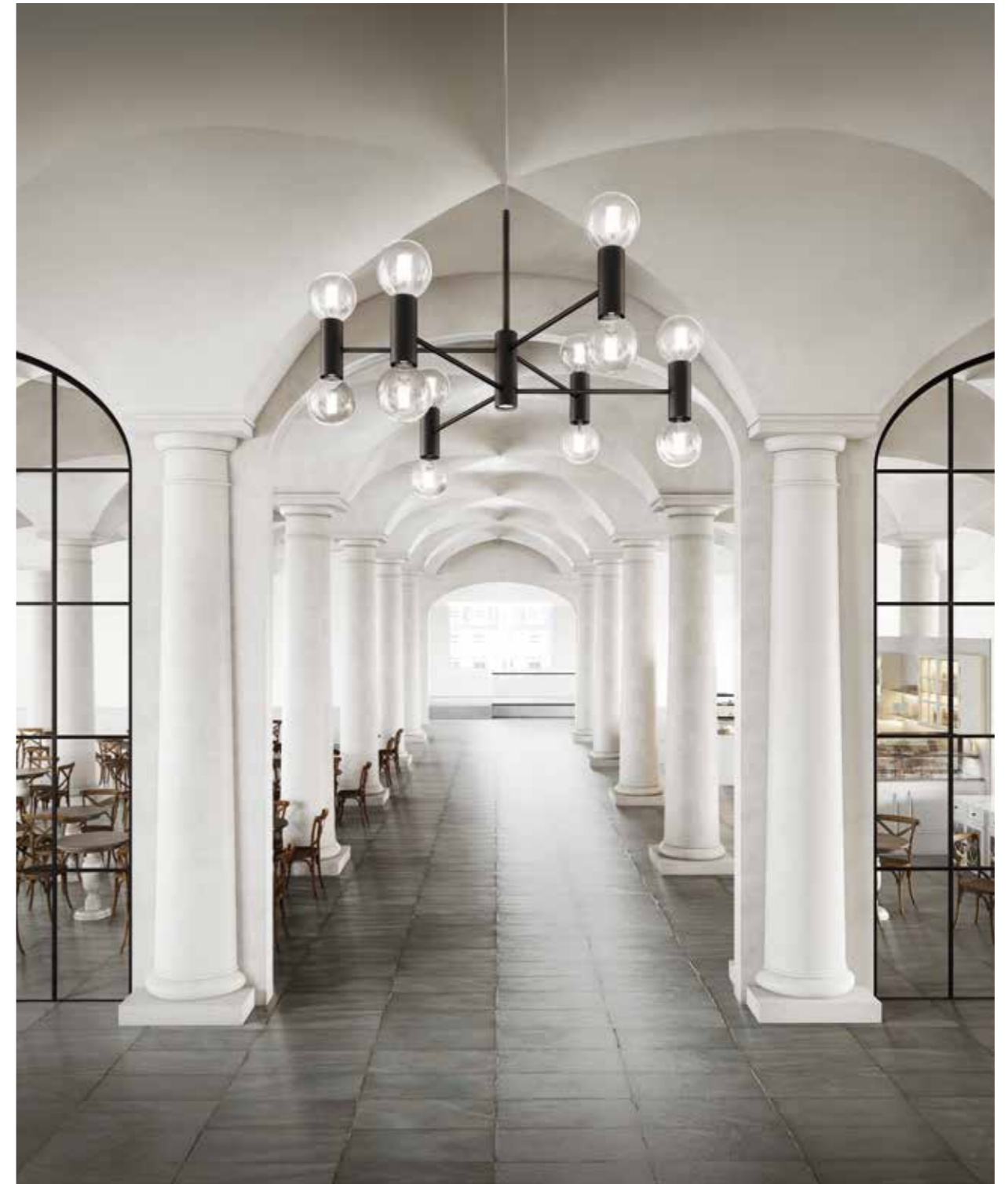



Lamp		Dimensions	Light source	Codes
Pendant lamp	Chandelier 100	Ø 107 x 76 cm weight 10 kg	lamp type 12 x E27 + 1 x GU10 max watt 12 x 42 W + 1 x 28 W HES DIM	CHAESO100G01
	Chandelier 100	Ø 100 x 63 cm weight 10 kg	lamp type 13 x GU10 max watt 13 x 28 W HES DIM	CHAESO100G11
	Chandelier 140	Ø 147 x 76 cm weight 12 kg	lamp type 12 x E27 + 1 x GU10 max watt 12 x 42 W + 1 x 28 W HES DIM	CHAESO140G01
	Chandelier 140	Ø 140 x 63 cm weight 12 kg	lamp type 13 x GU10 max watt 13 x 28 W HES DIM	CHAESO140G11

Pendant lamp

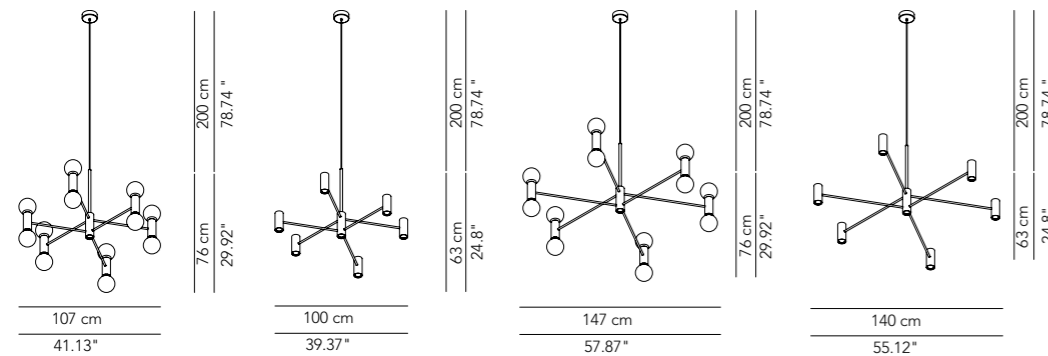

Finishes

Body colours



White



Black



Matt gold



Dark teal

Central Rod (Option)



Gold

Lampada in metallo/
Metal structure

Biemissione/
Uplight and downlight

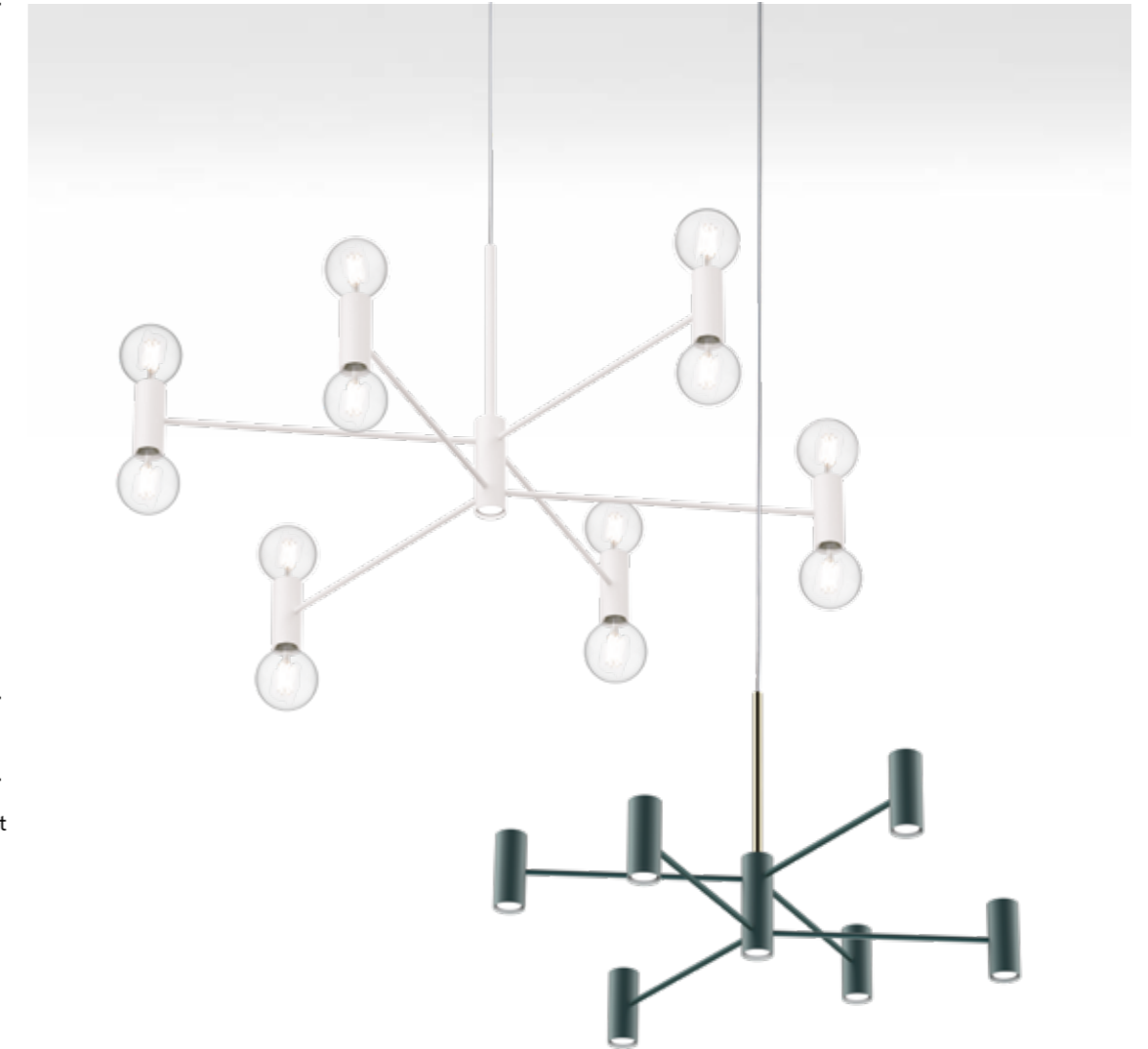

IP20



White



Black



Matt gold



Dark Teal

Dettaglio rosone/
Ceiling rose detail

* on demand

** cable on measure



Lamp		Dimensions	Light source	Codes
Ceiling lamp	Chandelier 100	Ø 107 x 62 cm weight 10 kg	lamp type 6 x E27 + 7 x GU10 max watt 6 x 42 W + 7 x 28 W HES DIM	CHAEPL100G01
	Chandelier 100	Ø 100 x 49 cm weight 10 kg	lamp type 13 x GU10 max watt 13 x 28 W HES DIM	CHAEPL100G11
	Chandelier 140	Ø 147 x 62 cm weight 12 kg	lamp type 6 x E27 + 7 x GU10 max watt 6 x 42 W + 7 x 28 W HES DIM	CHAEPL140G01
	Chandelier 140	Ø 140 x 49 cm weight 12 kg	lamp type 13 x GU10 max watt 13 x 28 W HES DIM	CHAEPL140G11
Wall lamp	Chandelier	Ø 13 x 20 x 39 cm weight 1 kg	lamp type 2 x E27 max watt 2 x 42 W HES DIM	CHAEAP010G01
	Chandelier	Ø 8 x 17 x 20 cm weight 1 kg	lamp type 2 x GU10 max watt 2 x 28 W HES DIM	CHAEAP010G11
	Chandelier	Ø 35 x 20 x 39 cm weight 2 kg	lamp type 4 x E27 max watt 4 x 42 W HES DIM	CHAEAP035G01
	Chandelier	Ø 29 x 17 x 20 cm weight 2 kg	lamp type 4 x GU10 max watt 4 x 28 W HES DIM	CHAEAP035G11

Ceiling lamp

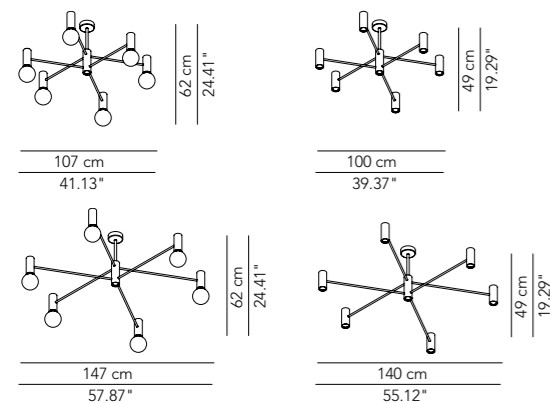

Wall lamp

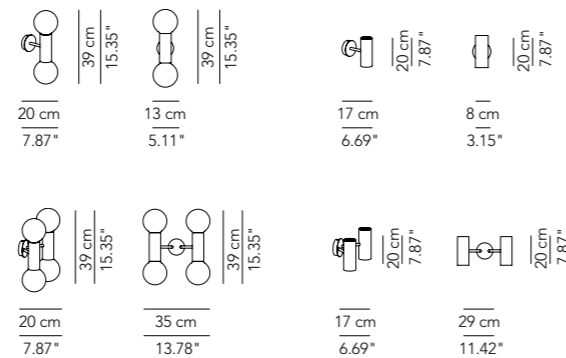

Finishes

Body colours



White



Black



Matt gold



Dark teal

Central Rod (Option)



Gold

Lampada in metallo/
Metal structure

Biemissione/
Uplight and downlight

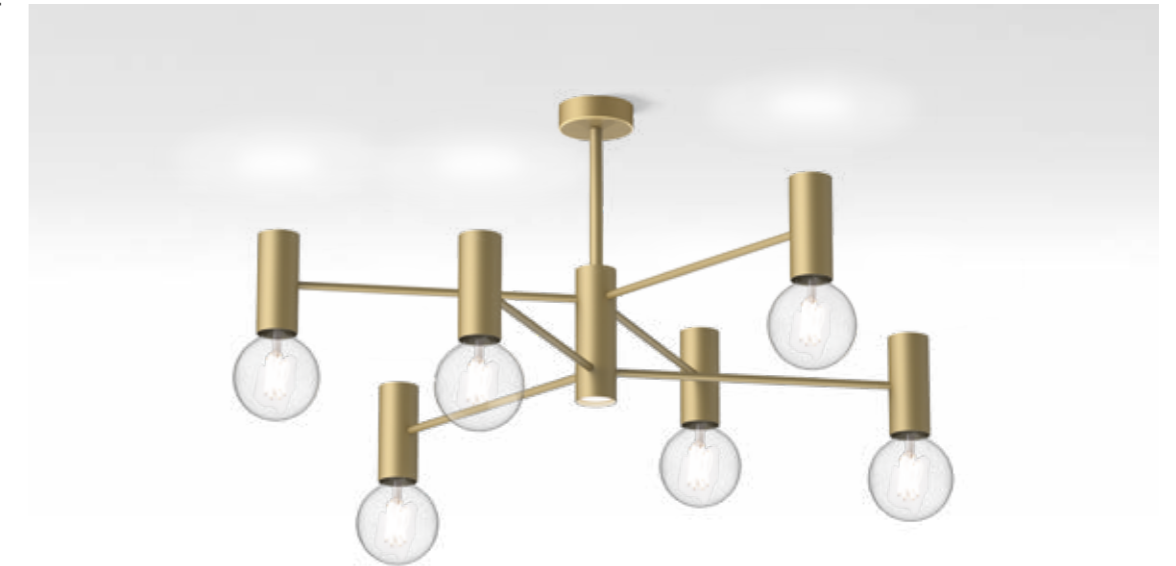

IP20



* on demand



Applique singola/
Single wall lamp



Applique singola/
Single wall lamp



Applique doppia/
Double wall lamp



Applique doppia/
Double wall lamp



Lamp	Dimensions	Light source	Codes
Pendant lamp Chandelier Longue 100	Ø 110 x 55 x 50 cm weight 12 kg	lamp type 16 x E27 + 2 x GU10 max watt 16 x 42 W + 2 x 28 W HES DIM	CHLESO100G01
Chandelier Longue 100	Ø 105 x 48 x 40 cm weight 12 kg	lamp type 18 x GU10 max watt 18 x 28 W HES DIM	CHLESO100G11
Chandelier Longue 150	Ø 150 x 70 x 50 cm weight 14 kg	lamp type 16 x E27 + 2 x GU10 max watt 16 x 42 W + 2 x 28 W HES DIM	CHLESO150G01
Chandelier Longue 150	Ø 140 x 65 x 40 cm weight 14 kg	lamp type 18 x GU10 max watt 18 x 28 W HES DIM	CHLESO150G11

Pendant lamp

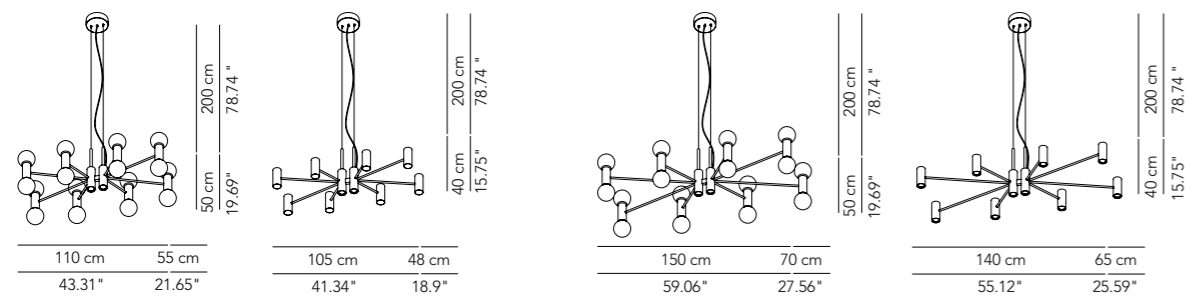

Finishes

Body colours



White



Black



Matt gold



Dark teal

Central Rod (Option)



Gold

Lampada in metallo/
Metal structure

Biemissione/
Uplight and downlight

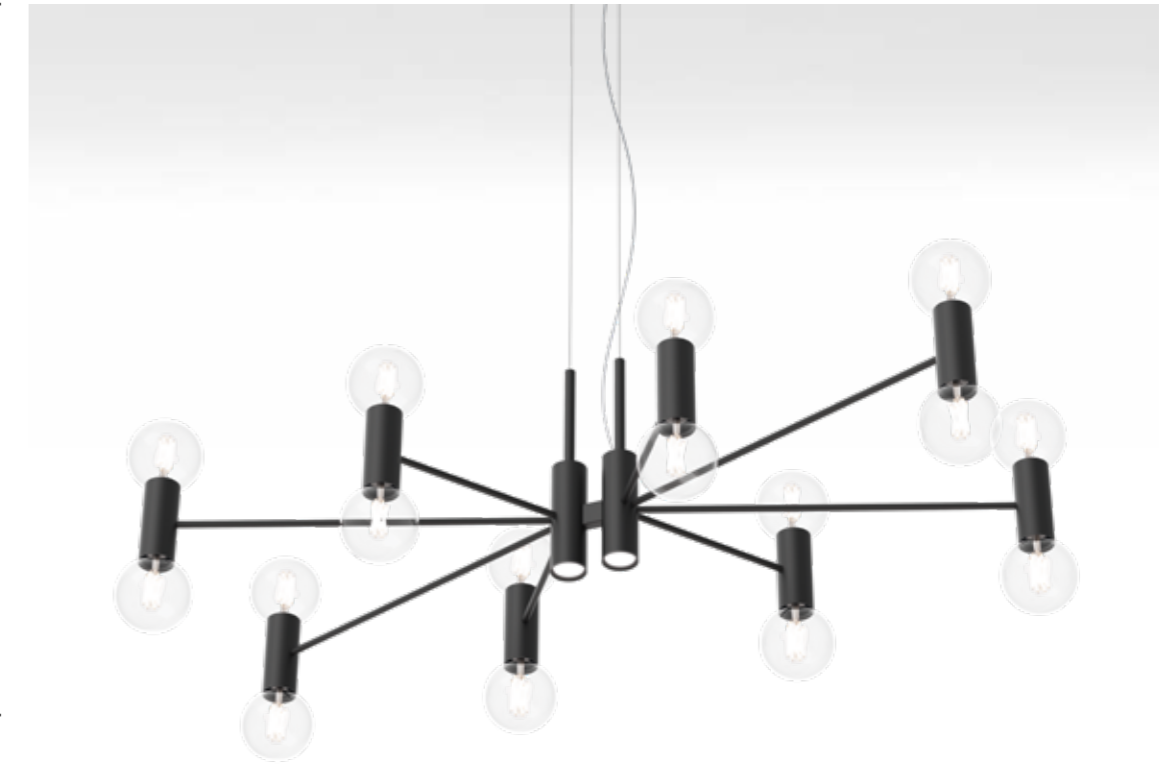

IP20



* on demand

** cable on measure



White



Black



Matt gold



Dark Teal

Dettaglio rosone/
Ceiling rose detail



Lamp	Dimensions	Light source	Codes
Ceiling lamp Chandelier Longue 100	Ø 110 x 55 x 54 cm weight 12 kg	lamp type 8 x E27 + 10 x GU10 max watt 8 x 42 W + 10 x 28 W HES DIM	CHLEPL100G01
Chandelier Longue 100	Ø 105 x 48 x 44 cm weight 12 kg	lamp type 18 x GU10 max watt 18 x 28 W HES DIM	CHLEPL100G11
Chandelier Longue 150	Ø 150 x 70 x 54 cm weight 14 kg	lamp type 8 x E27 + 10 x GU10 max watt 8 x 42 W + 10 x 28 W HES DIM	CHLEPL150G01
Chandelier Longue 150	Ø 140 x 65 x 44 cm weight 14 kg	lamp type 18 x GU10 max watt 18 x 28 W HES DIM	CHLEPL150G11

Ceiling lamp

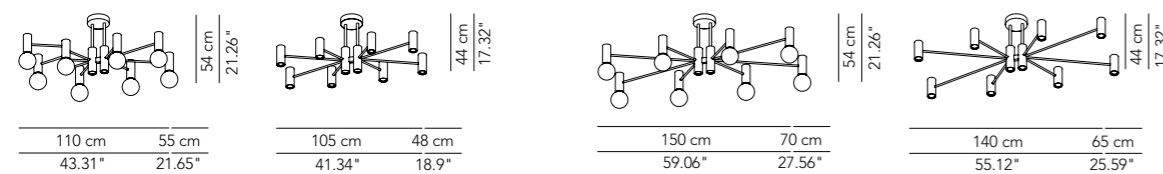

Finishes

Body colours



White



Black



Matt gold



Dark teal

Central Rod
(Option)



Gold

Lampada in metallo/
Metal structure

Biemissione/
Uplight and downlight

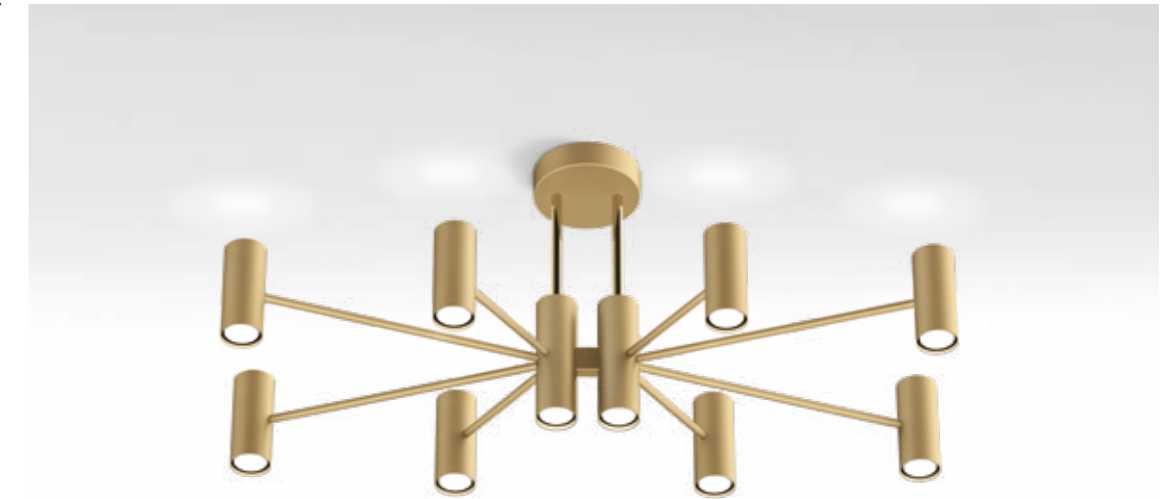

IP20



* on demand



CHARLIE

Un anello in metallo racchiude un cilindro in tessuto che come per magia si libra nell'aria. Sembra rubata alla luna piena la luce morbida e magnetica di Charlie, lampada a sospensione e soffitto dalle forme raffinate e confidenziali.

A metal ring encloses a fabric cylinder that floats in the air as if by magic. Charlie's soft, magnetic light seems to have been stolen from the moon, and the shapes of the hanging and ceiling lamps are both elegant and reassuringly familiar.







Lamp		Dimensions	Light source	Codes
Pendant lamp	Charlie 107	Ø 107 x 22 cm weight 25 kg	lamp type 4 x E27 max watt 4 x 105 W HES DIM	CARESP100C01
	Charlie 107 led	Ø 107 x 22 cm weight 25 kg	lamp type 1 led module 29,3 W luminous efficacy 3900 Lm light colour 2700 K DIM DALI - push DIM / triac CRI > 80	CARESP100C02
	Charlie 107 led	Ø 107 x 22 cm weight 25 kg	lamp type 1 led module 35 W luminous efficacy 5600 Lm light colour 2700 K DIM DALI - push DIM CRI > 80	CARESP100C05
	Charlie 127	Ø 127 x 22 cm weight 35 kg	lamp type 4 x E27 max watt 4 x 105 W HES DIM	CARESP130C01
	Charlie 127 led	Ø 127 x 22 cm weight 35 kg	lamp type 1 led module 29,3 W luminous efficacy 3900 Lm light colour 2700 K DIM DALI - push DIM / triac CRI > 80	CARESP130C02
	Charlie 127 led	Ø 127 x 22 cm weight 35 kg	lamp type 1 led module 35 W luminous efficacy 5600 Lm light colour 2700 K DIM DALI - push DIM CRI > 80	CARESP130C05
	Charlie 127 led	Ø 127 x 22 cm weight 35 kg	lamp type 1 led module 88,2 W luminous efficacy 11780 Lm light colour 2700 K DIM DALI - push DIM CRI >80	CARESP130C07

Pendant lamp

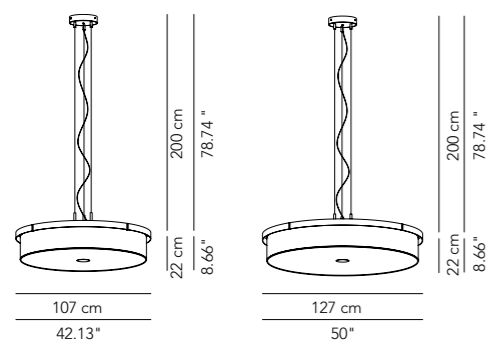

Finishes

Body colours

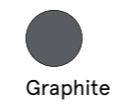

Diffuser textiles

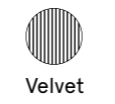

Diffusore in tessuto,
struttura in metallo/
Fabric lampshade,
metal structure



IP20



* on demand
** cable on measure



Dettaglio rosone/
Ceiling rose detail



Lamp		Dimensions	Light source	Codes
Ceiling lamp	Charlie 107	Ø 107 x 25 cm weight 25 kg	lamp type 4 x E27 max watt 4 x 105 W HES DIM	CAREPL100C01
	Charlie 107 led	Ø 107 x 25 cm weight 25 kg	lamp type 1 led module 29,3 W luminous efficacy 3900 Lm light colour 2700 K DIM DALI - push DIM / triac CRI > 80	CAREPL100C02
	Charlie 107 led	Ø 107 x 25 cm weight 25 kg	lamp type 1 led module 35 W luminous efficacy 5600 Lm light colour 2700 K DIM DALI - push DIM CRI > 80	CAREPL100C05
	Charlie 127	Ø 127 x 25 cm weight 35 kg	lamp type 4 x E27 max watt 4 x 105 W HES DIM	CAREPL130C01
	Charlie 127 led	Ø 127 x 25 cm weight 35 kg	lamp type 1 led module 29,3 W luminous efficacy 3900 Lm light colour 2700 K DIM DALI - push DIM / triac CRI > 80	CAREPL130C02
	Charlie 127 led	Ø 127 x 25 cm weight 35 kg	lamp type 1 led module 35 W luminous efficacy 5600 Lm light colour 2700 K DIM DALI - push DIM CRI > 80	CAREPL130C05
	Charlie 127 led	Ø 127 x 25 cm weight 35 kg	lamp type 1 led module 88,2 W luminous efficacy 11780 Lm light colour 2700 K DIM DALI - push DIM CRI >80	CAREPL130C07

Ceiling lamp

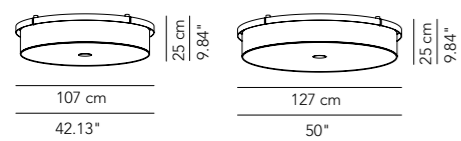

Finishes

Body colours

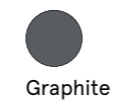

Diffuser textiles

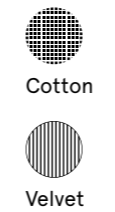

Diffusore in tessuto,
struttura in metallo/
Fabric lampshade,
metal structure



IP20

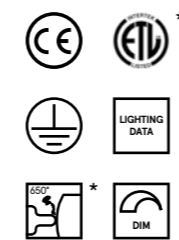

* on demand



GECO

Si arrampica sulla parete con estrema naturalezza proprio come il piccolo rettile da cui prende ispirazione la lampada Geco. Disponibile in diversi colori e in due versioni, con paralume o con lampadina a vista.

Climbing up the wall with poise and aplomb, just like the small reptile from which it draws its inspiration, is Geco lamp. Available in a range of colours, and in two different versions, with lampshade or with an exposed bulb.







Lamp		Dimensions	Light source	Codes
Wall lamp with plug	Geco 155	Ø 13 x 15 x 155 weight 5 kg	lamp type 1 x E27 max watt 42 W HES DIM	GECEAP160G01
	Geco 165	Ø 30 x 21 x 165 weight 5 kg	lamp type 1 x E27 max watt 42 W HES DIM	GECEAP160C01
without plug	Geco 155	Ø 13 x 17 x 155 weight 5 kg	lamp type 1 x E27 max watt 42 W HES DIM	GECEAP160G11
	Geco 165	Ø 30 x 23 x 165 weight 5 kg	lamp type 1 x E27 max watt 42 W HES DIM	GECEAP160C11

Wall lamp

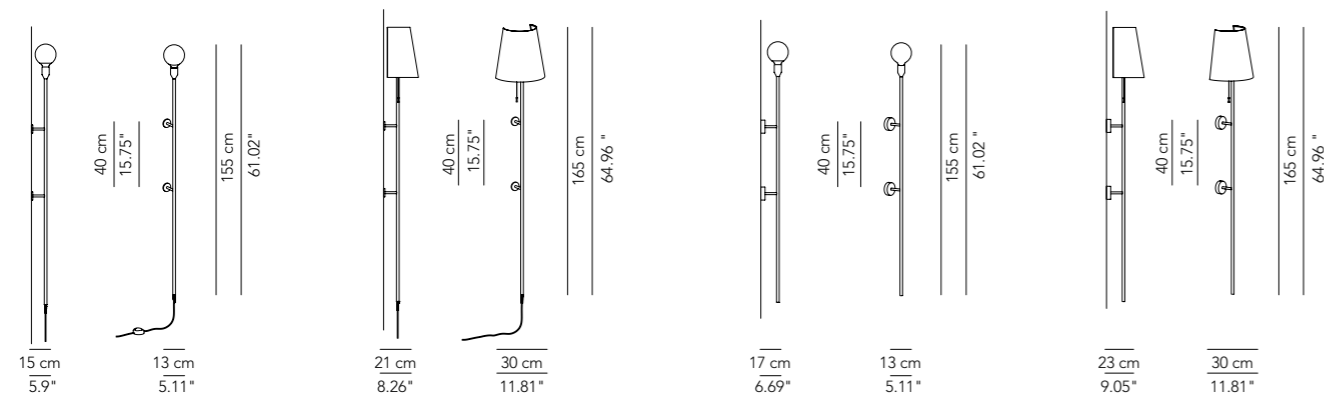

Finishes

Body colours



White



Black



Brick



Lime



Blu China



Matt gold

Diffuser textiles



Cotton

Diffusore in tessuto, struttura in metallo/
Fabric lampshade, metal structure

IP20



* on demand



Abbinamenti cromatici consigliati/
Suggested colour matching



NUCLEO

Un disco luminoso, come il sole, si muove dentro un percorso ellittico in veste di archetipa fonte di luce. La sospensione Nucleo illumina lo spazio in modo dinamico, grazie a una sorgente Led che scorre all'interno della struttura in metallo che la ospita.

A bright disc glides along an elliptical course like the sun, playing the role of the archetypal light source. Nucleo hanging lamp dynamically illuminates its space, thanks to a LED source that slides within its metal frame.







Lamp		Dimensions	Light source	Codes
Pendant lamp	Nucleo 130	Ø 130 x 35 x 2 cm weight 8 kg	lamp type 1 Panel led 24 W luminous efficacy 2150 Lm light colour 2800 K DIM DALI /push DIM CRI > 85	NUCESO130G01
	Nucleo 160	Ø 160 x 35 x 2 cm weight 12 kg	lamp type 2 Panel led 24 W luminous efficacy 4300 Lm light colour 2800 K DIM DALI /push DIM CRI > 85	NUCESO160G01

Pendant lamp

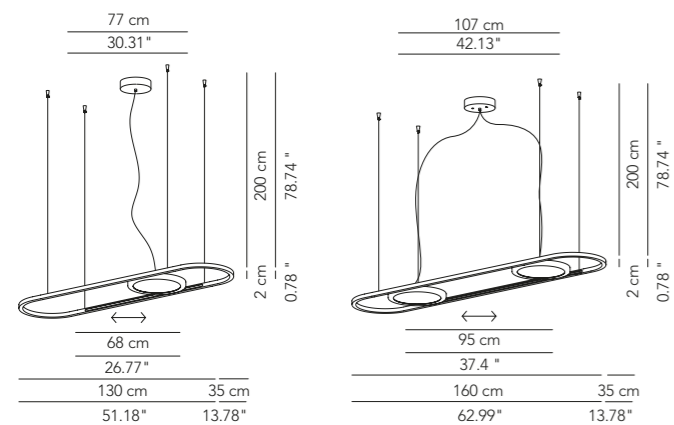

Raccordo sospensione
1 cavo acciaio /
Connection for
suspension 1 steel cable

Finishes

Body colours



White



Graphite



Chrome

Diffuser



White



Graphite



Chrome



Copper



Brass

Luce diretta/
Direct light

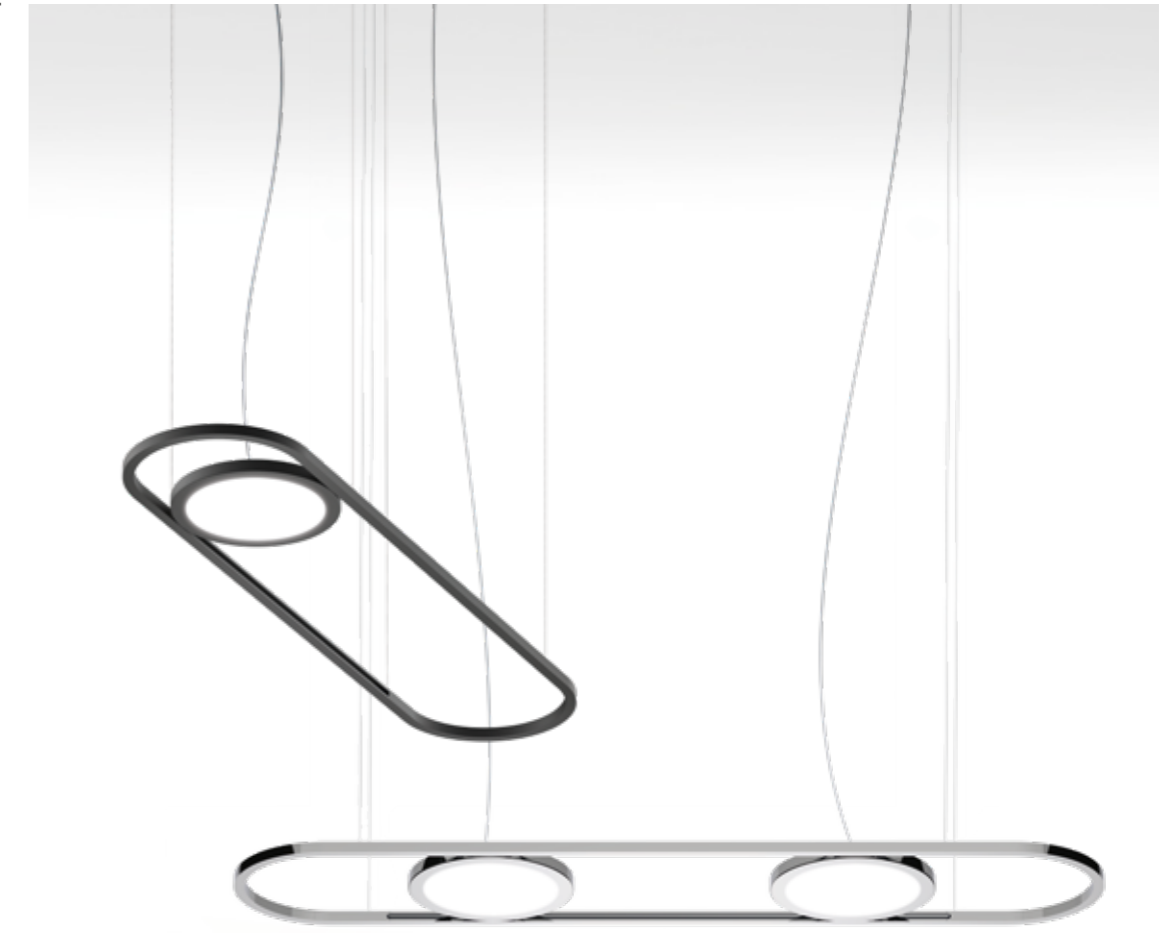

IP20



* on demand
** cable on measure



White



White

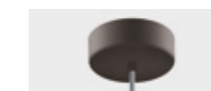

Graphite

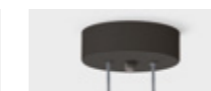

Graphite



Chrome



Chrome

Dettaglio rosone
L130/
Ceiling rose detail
L130

Dettaglio rosone
L160/
Ceiling rose detail
L160



Il diffusore Led scorre all'interno della struttura/
Led source slides within its metal structure

ENJOY THE SILENCE

Abbiamo a cuore la salute e il benessere delle persone in ogni momento della giornata. Per questo abbiamo deciso di progettare forme di luce innovative e funzionali che, a una perfetta illuminazione, uniscono elevate prestazioni di fonoassorbimento.

Spesso trascurato, l'inquinamento acustico è un fattore di disturbo che mina la serenità negli spazi di relax e la produttività nei luoghi di lavoro. Le nostre soluzioni catturano rumori e riverberi rendendo gli ambienti sani e confortevoli.

We have at heart the health and the wellbeing of the people every waking moment. Therefore, we have decided to project innovative and functional shapes of light, which combine to a perfect illumination high sound absorbing characteristics.

Often ignored, the acoustic pollution is a disturbing factor that threatens the serenity in our leisure spaces and productivity of workers. Our solutions catch the noises and reverberations making the spaces healthy and comfortable.

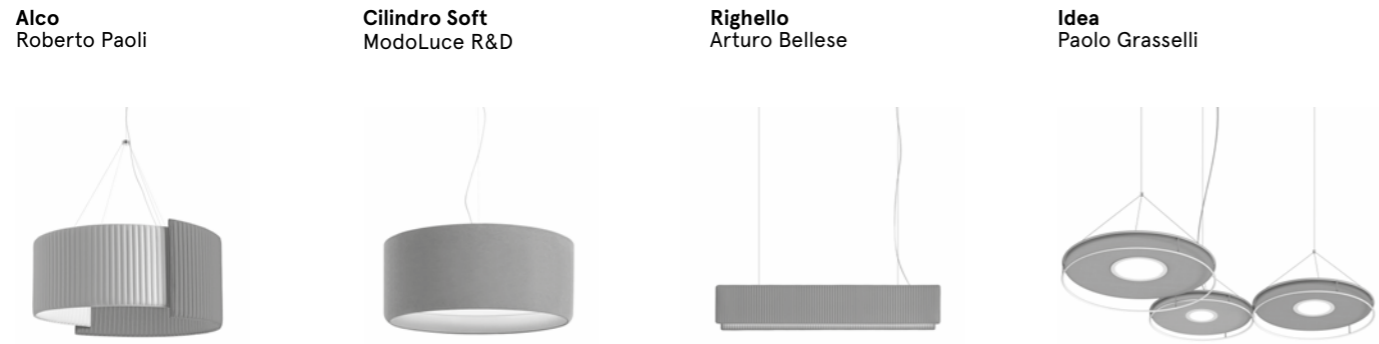

Alco Kvadrat

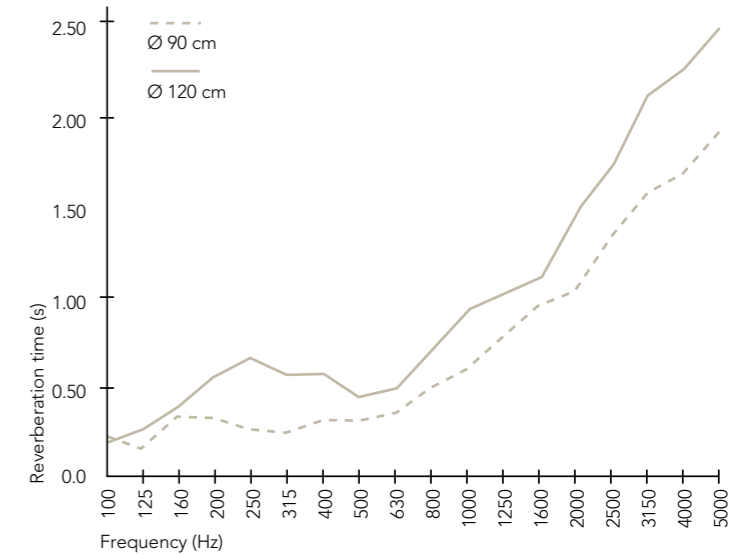

Alco Soft Textile thermoformed

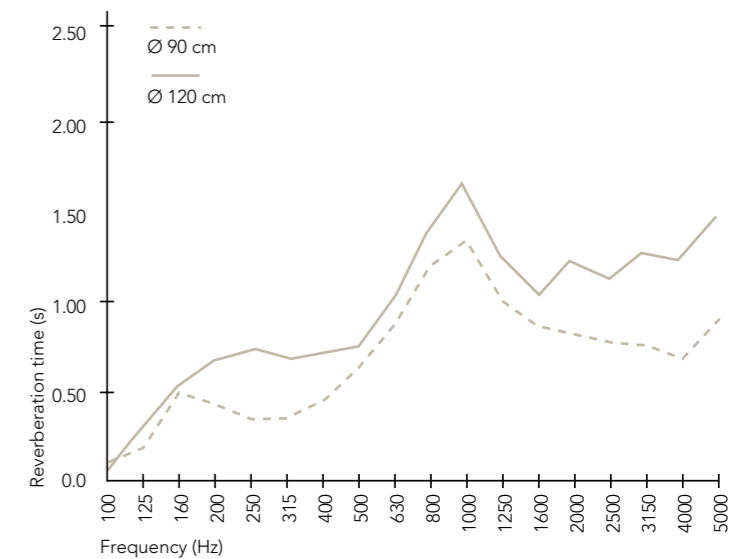

Cilindro Soft Velvet

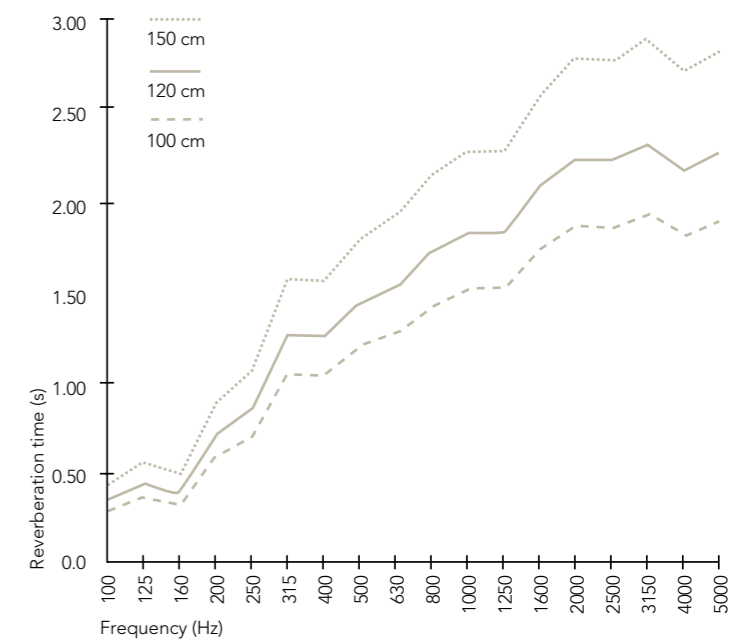



IDEA

Leggere strutture in metallo incorniciano dischi in tessuto che accolgono al centro il corpo illuminante. Idea arreda lo spazio in modo inedito e originale, in versione sospensione o plafoniera/ applique è pensata come elemento singolo o in composizione.

Lightweight metal structures frame fabric discs, at the centre of which is the light source itself. Idea creates a unique and original decor in any space. Available as a hanging lamp, ceiling or wall lamp, it is designed to work alone or as a composition.

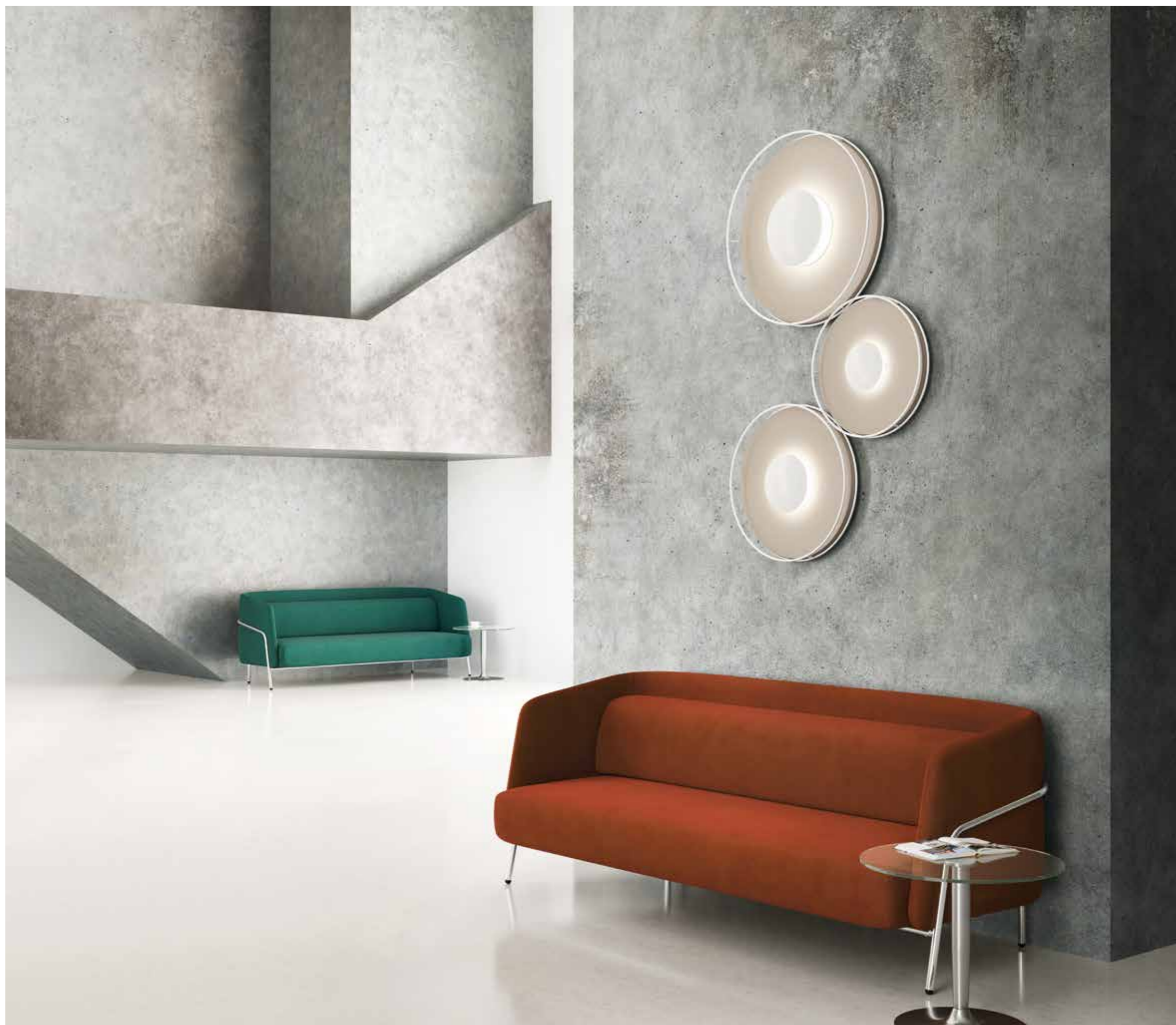





Lamp		Dimensions	Light source	Codes
Pendant lamp	Idea 66	Ø 66 x 10 cm weight 10 kg	lamp type 1 Panel led 18 W luminous efficacy 1660 Lm light colour 2800 K DIM DALI /push DIM CRI > 85	IDEESO060L01
	Idea 80	Ø 80 x 10 cm weight 15 kg	lamp type 1 Panel led 24 W luminous efficacy 2150 Lm light colour 2800 K DIM DALI /push DIM CRI > 85	IDEESO080L01
	Idea 100	Ø 100 x 10 cm weight 18 kg	lamp type 1 Panel led 24 W luminous efficacy 2150 Lm light colour 2800 K DIM DALI /push DIM CRI > 85	IDEESO100L01
	Idea 140	Ø 140 x 10 cm weight 25 kg	lamp type 1 Panel led 30 W luminous efficacy 2400 Lm light colour 2800 K DIM DALI /push DIM CRI > 85	IDEESO140L01

Pendant lamp

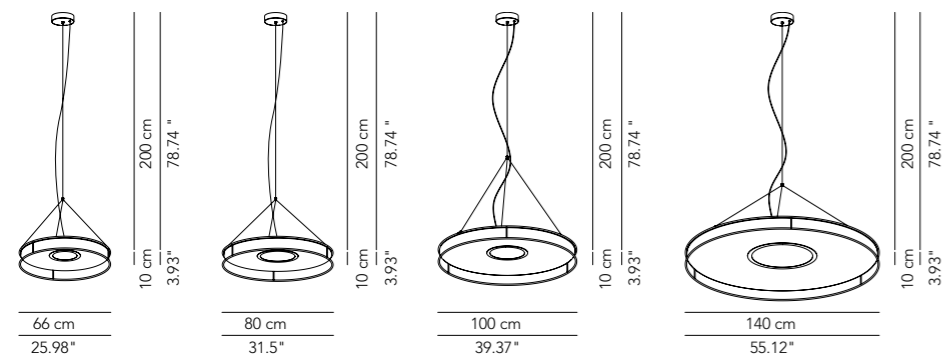

Finishes

Body colours



White



Graphite

Diffuser textiles



Lycra

Lampada in metallo,
dischi in tessuto
lycra sfoderabile/
Metal structure,
removable lycra
fabric disks

Luce diretta/
Direct light



IP20



White



Graphite

Dettaglio rosone/
Ceiling rose detail

* on demand

** cable on measure



Lamp		Dimensions	Light source	Codes
Pendant lamp	Idea 100	Ø 100 x 58 x 9 cm weight 15 kg	lamp type 3 Panel led 3 W + 6 W + 9 W luminous efficacy 1480 Lm light colour 2800 K DIM DALI /push DIM CRI > 85	IDEEDD100L03
	Idea 180	Ø 180 x 105 x 10 cm weight 30 kg	lamp type 3 Panel led 12 W + 18 W + 24 W luminous efficacy 4920 Lm light colour 2800 K DIM DALI /push DIM CRI > 85	IDEEDD180L03

Pendant lamp

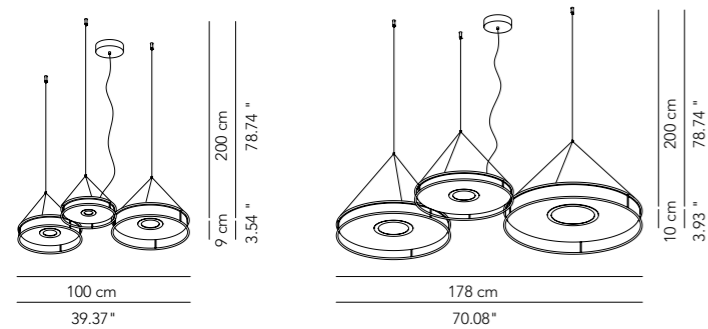

Finishes

Body colours



White



Graphite

Diffuser textiles



Lycra

Struttura in metallo,
dischi in tessuto
lycra sfoderabile/
Metal structure,
removable lycra
fabric disks

Luce diretta/
Direct light



IP20

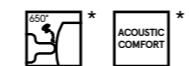

White



Graphite

Dettaglio rosone/
Ceiling rose detail

* on demand

** cable on measure



Lamp		Dimensions	Light source	Codes
Ceiling lamp	Idea 66	Ø 66 x 13 cm weight 10 kg	lamp type 1 Panel led 18 W luminous efficacy 1660 Lm light colour 2800 K DIM DALI /push DIM CRI > 85	IDEEPL060L01
	Idea 80	Ø 80 x 13 cm weight 15 kg	lamp type 1 Panel led 24 W luminous efficacy 2150 Lm light colour 2800 K DIM DALI /push DIM CRI > 85	IDEEPL080L01
	Idea 100	Ø 100 x 13 cm weight 18 kg	lamp type 1 Panel led 24 W luminous efficacy 2150 Lm light colour 2800 K DIM DALI /push DIM CRI > 85	IDEEPL100L01
	Idea 140	Ø 140 x 3 cm weight 25 kg	lamp type 1 Panel led 30 W luminous efficacy 2400 Lm light colour 2800 K DIM DALI /push DIM CRI > 85	IDEEPL140L01
Ceiling lamp composition	Idea 100	Ø 100 x 58 x 13 cm weight 15 kg	lamp type 3 Panel led 3 W + 6 W + 9 W luminous efficacy 1480 Lm light colour 2800 K DIM DALI /push DIM CRI > 85	IDEEDD100L03
	Idea 180	Ø 180 x 105 x 13 cm weight 30 kg	lamp type 3 Panel led 12 W + 18 W + 24 W luminous efficacy 4920 Lm light colour 2800 K DIM DALI /push DIM CRI > 85	IDEEDD180L03

Wall lamp / Ceiling lamp

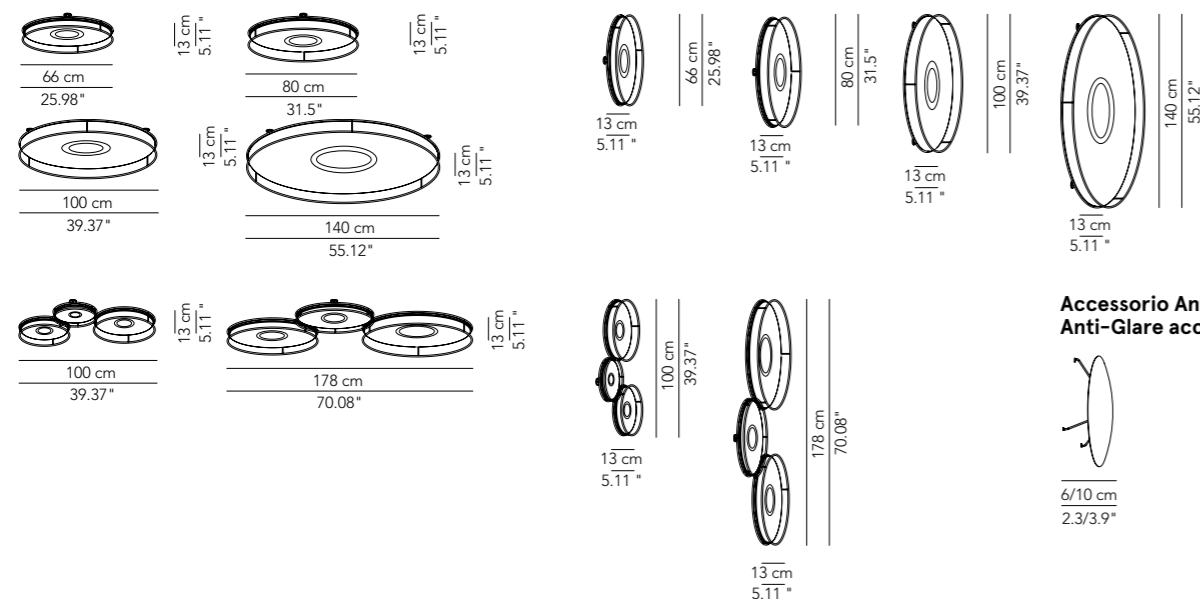

Accessorio Antiabbaglio / Anti-Glare accessory



Finishes

Body colours



White



Graphite

Diffuser textiles



Lycra

Struttura in metallo,
dischi in tessuto
lycra sfoderabile/
Metal structure,
removable lycra
fabric disks

Luce diretta/
Direct light



IP20

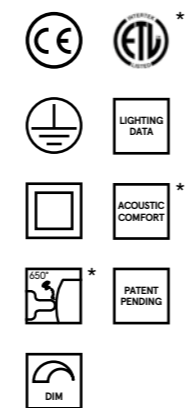

* on demand



Dettaglio accessorio antiabbaglio / Anti-Glare accessory detail

CARATTERISTICHE
TECNICHE /
TECHNICAL
SPECIFICATION

Sorgenti luminose

I prodotti Modo Luce equipaggiati con attacco GU10, E14 e E27 vengono consegnati senza lampadine.

Temperatura colore

Le lampade Modo Luce equipaggiate con sorgente led vengono fornite di serie con temperatura di colore 2700K. Sono disponibili su richiesta anche le versioni 3000K e 4000K.

Lumen

L'indicazione del flusso luminale si riferisce al valore in assenza di rifrazione, come dichiarato dal produttore del componente led.

Light Sources

Modo Luce products equipped with GU10, E14 and E27 are delivered without light bulbs.

Color temperature

Modo Luce led equipped products are supplied with 2700K light colour as standard version. 3000K and 4000K are available on request.

Lumen









Nominal luminous flux refers to the value without any refraction as declared by the led module manufacture.

Legenda lampadine

Lampadine utilizzabili sui prodotti Modo Luce (secondo i modelli).

Legend light bulbs

Light bulbs available for Modo Luce products (according to the models).

Tipo / Type	Simbolo / Symbol	Attacco / Socket	Potenza / Power	Codice / Code
Halogen Energy Saver	 Classic	E27	28W/42W/70W/105W	LMPHESE27G00
	 Globe Clair	E27	42W	LMPHESE27G00
	 Dichroic	GU10	20W/28W	LMPARGU1000
Led No Dim	 Classic	E27	6W/9W/12W	LMPLEDE27G00
	 Globe Clair	E27	4W/6W/9W	LMPLED2E27GL4W125
	 Dichroic	GU10	6W	LMPLEDE27GU10
Led Dim	 Classic	E27	10W/12W/17W	LMPLEE27GDO
	 Globe Clair	E27	7.5W	LMPLEDE27DIM125
	 Dichroic	GU10	6W	LMPLEDGU10DIM06

Rosoni / Ceiling rose + Pendant lamp

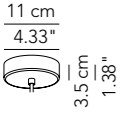
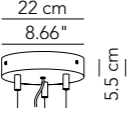
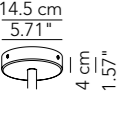
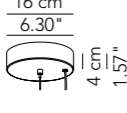
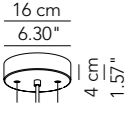
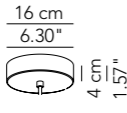
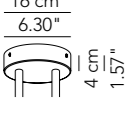
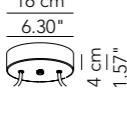
 <p>11 cm 4.33" 3.5 cm 1.38"</p> <p>Chandelier Idea Composition</p>	 <p>22 cm 8.66" 5.5 cm 2.16"</p> <p>Charlie</p>
 <p>14.5 cm 5.71" 4 cm 1.57"</p> <p>Chandelier Ceiling lamp</p>	 <p>16 cm 6.30" 4 cm 1.57"</p> <p>Idea single</p>
 <p>16 cm 6.30" 4 cm 1.57"</p> <p>Chandelier Lounge</p>	 <p>16 cm 6.30" 4 cm 1.57"</p> <p>Nucleo 130</p>
 <p>16 cm 6.30" 4 cm 1.57"</p> <p>Chandelier Lounge Ceiling lamp</p>	 <p>16 cm 6.30" 4 cm 1.57"</p> <p>Nucleo 160</p>

Modo Luce srl fornisce le sospensioni con i seguenti standard (misura utile):

- Cavo elettrico L 200 cm
- Cavo elettrico L 250 cm per apparecchi con 2 o più cavi acciaio
- Cavo acciaio L 200 cm

** Disponibilità a misura su richiesta



Modo Luce srl delivers the following standard cables for the suspensions (useful measures):

- Power wire L 200 cm / L 78.74"
- Power wire L 250 cm / L 98.42" for fixtures with 2 or more steel cables
- Steel cable L 200 cm / L 78.74"

** Other measures are available upon demand

Accessori a richiesta / Accessory on demand

Codici / Codes

Wiring power coaxial cable, FEP + PVC transparent extra flexible 2x0.5 to each linear meter	CAVCOA05000T02
Wiring, power cable teflon, pvc transparent 2/3 x 0,75 (longer than standard length) to each linear meter NO DIM	CAVELE000000
Wiring, power cable teflon, pvc transparent 4 x 0,75 (longer than standard length) to each linear meter NO DIM	CAVELE000000T04
Wiring, power cable round pvc, pvc white to each linear meter	CAVELE00000BT01
Wiring, power cable round pvc, pvc black to each linear meter	CAVELE00000NT01
Wiring, power cable round pvc, pvc grey to each linear meter	CAVELE00000GT01
Wiring, power cable teflon, pvc DIMMABLE white or black for suspension lamp to each linear meter	CAVELEDIM000TB05
Wiring cable teflon, pvc DIMMABLE transparent for suspension lamp to each linear meter	CAVELEDIM000TT05
Wiring, power cable outdoor round 2x0,75 H05RN-F black to each linear meter	CAVELE0000EN
Fabric wiring, power cable for suspension lamp to each linear meter	CAVCAL000000
Steel cable for suspension lamp Ø 1,2 x h 2000 mm / Ø 0,47" x L 78,74"	CAVACC012200000
Steel cable for suspension lamp Ø 1,2 x h 3000 mm / Ø 0,47" x L 118,11"	CAVACC012300000
Steel cable for suspension lamp Ø 1,2 x h 6000 mm / Ø 0,47" x L 236,22"	CAVACC012600000
Steel cable for suspension lamp Ø 1,2 x h 10000 mm / Ø 0,47" x L 393,70"	CAVACC012100000
Steel cable for suspension lamp Ø 1,6 x h 2000 mm / Ø 0,63" x L 78,74"	CAVACC016200000
Steel cable for suspension lamp Ø 1,6 x h 3000 mm / Ø 0,63" x L 118,11"	CAVACC016300000
Steel cable for suspension lamp Ø 1,6 x h 8000 mm / Ø 0,63" x L 314,96"	CAVACC016800000
DIM switch universal HES (40/160W) + LED (4/100W) 	DIMVAROTA002000
DIM switch universal HES, LED (5/250W) 	DIMVAROPT003000
Uk plug adapter 	ADAUK240V001

Finiture diffusore / Diffuser finishes



Cotton

Charlie, Geco



Velvet

Charlie

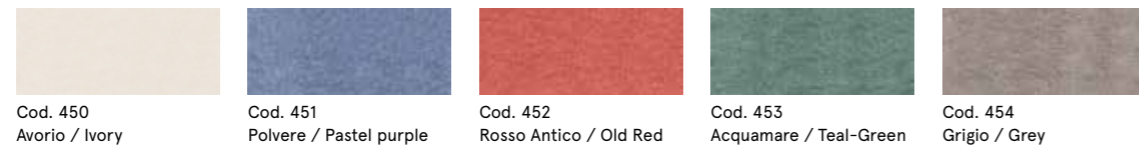

Lykra

Idea

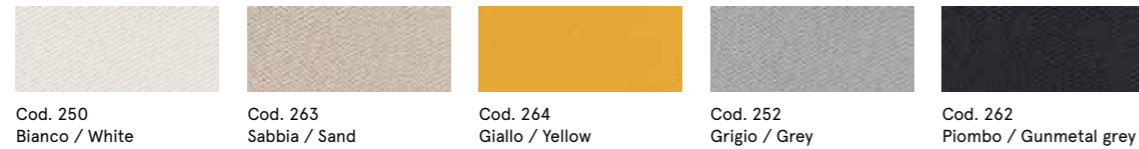

Finiture Struttura / Structure Finishes

Metal

Chandelier



Charlie



Idea

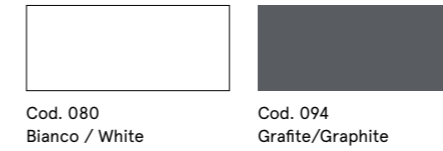

Nucleo

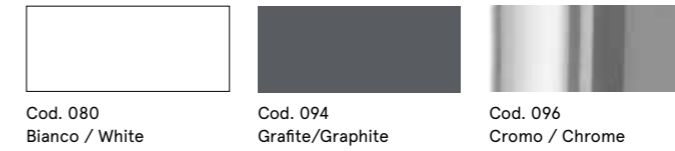

Nucleo diffusore

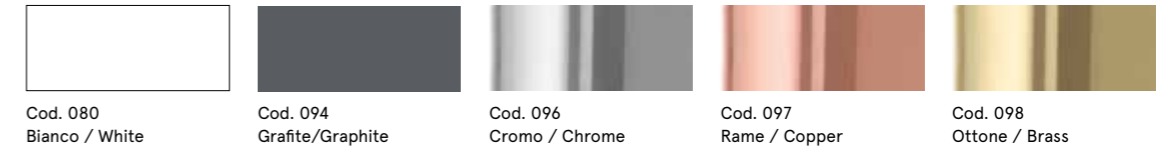

Geco

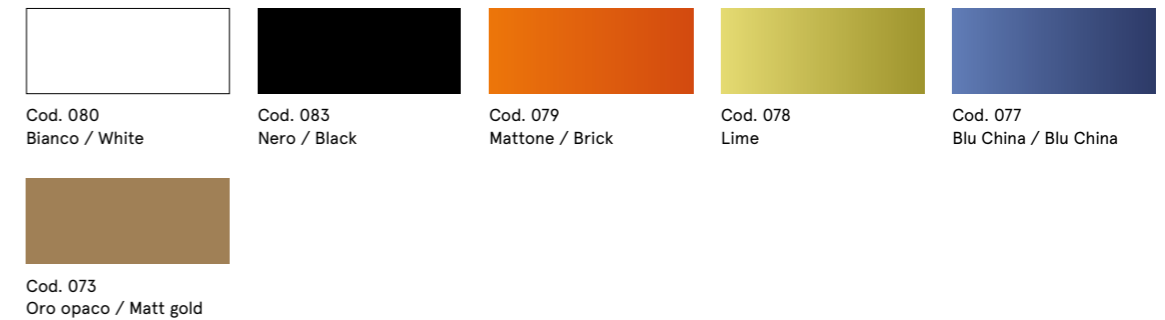

Pesi / Weights

Chandelier				Geco			
Pendant – ceiling lamp	D 100	10 Kg	22.02 lb.	Wall lamp	D 13	5 Kg	11.01 lb.
Pendant – ceiling lamp	D 100	12 Kg	26.43 lb.	Wall lamp	D 30	5 Kg	11.01 lb.
Wall lamp single	D 13	1 Kg	2.20 lb.				
Wall lamp double	D 35	2 Kg	4.41 lb.				
Chandelier Loungue				Idea			
Pendant – ceiling lamp	L 110	12 Kg	26.43 lb.	Pendant – ceiling lamp	D 66	10 Kg	22.02 lb.
Pendant – ceiling lamp	L 150	14 Kg	30.83 lb.	Pendant – ceiling lamp	D 80	15 kg	33.04 lb.
				Pendant – ceiling lamp	D 100	18 Kg	39.65 lb.
				Pendant – ceiling lamp	D 140	25 Kg	55.06 lb.
Charlie				Idea Composition			
Pendant – ceiling lamp	D 107	25 Kg	55.06 lb.	Pendant – ceiling lamp	D 100	15 Kg	33.04 lb.
Pendant – ceiling lamp	D 127	35 Kg	77.09 lb.	Pendant – ceiling lamp	D 180	30 Kg	66.14 lb.
Nucleo							
				Pendant lamp	L 130	8 kg	17.66 lb.
				Pendant lamp	L 160	12 Kg	26.43 lb.

Modo Luce - EELc Product List Global Energy Efficiency Label compatibility (EU Regulation 874/2012)

Le informazioni qui riportate riguardanti le Classi Energetiche, non sono esaustive di tutti i tipi di lampadine effettivamente reperibili sul mercato europeo.

Gli apparecchi Modo Luce sono compatibili con lampadine che presentino l'etichetta energetica in conformità con il regolamento UE 874/2012.

Le etichette energetiche sono disponibili e scaricabili dal sito internet modoluce.com

The below information regarding the energy efficiency classes are not including all the bulbs available on European market.

Modo Luce fixtures are compatible with bulbs having the energy efficiency label in comply with UE 874/2012 regulation.

Energy labels are available and downloaded from the website modoluce.com

Photo
Heads Collective

Graphic design
Heads Collective

Colour separation
Heads Collective

Print
Grafica Bieffe
Printed in June 2019



Tutti i nostri prodotti sono realizzati completamente in Italia. Modo Luce is made in Italy.

Modo Luce S.r.l.
Tutti i diritti riservati.
Il logo Modo Luce è un marchio regolarmente depositato in ambito nazionale ed internazionale di esclusiva titolarità e proprietà di Modo Luce S.r.l. L'uso di tale logo per scopi commerciali, senza il precedente consenso scritto di Modo Luce S.r.l. può costituire violazione del marchio e concorrenza sleale in violazione alle leggi statali.

Il presente catalogo è tutelato dalla legge sui diritti d'autore (legge 22/41941 N. 633) e dalla legge 14/12/1942 n. 1485: di esso è proibita ogni riproduzione totale o anche parziale.

I dati riportati su questo catalogo sono indicativi e non costituiscono impegno da parte della Modo Luce Srl, che si riserva di apportare tutte le modifiche e migliorie ai propri prodotti, in osservanza della normativa CE senza obbligo di preavviso.

In particolare la costante evoluzione e i continui cambiamenti della tecnologia LED influenzano anche i nostri prodotti. Modo Luce è alla continua ricerca nell'individuare le soluzioni tecniche più aggiornate per migliorare la qualità della luce e l'efficienza energetica. Di conseguenza i dati riportati nel presente catalogo possono subire variazioni. Vi consigliamo di consultare il nostro sito internet modoluce.com che sarà costantemente aggiornato con i dati tecnici.

La marcatura CE indica che il prodotto soddisfa gli obblighi di legge in merito alle Direttive Comunitarie Europee applicabili allo stesso.

I colori dei prodotti possono variare rispetto a quanto rappresentato nel catalogo e da lotto a lotto.

All products are entirely made in Italy. Modo Luce is made in Italy.

Modo Luce S.r.l.
All rights reserved.
The logo Modo Luce is a regularly registered trademark in the national and international context and is the exclusive property of Modo Luce S.r.l. Use of said logo for commercial purposes, without the written permission of Modo Luce S.r.l., can constitute infringement of trademark and unfair competition in branch of the state laws.

This catalogue is safeguarded by the law on copyright (law 22/41941 no. 633) and by the law 14/12/1942 no. 1485: all total or even partial reproductions of the catalogue are forbidden.

Data contained in this catalogue is purely indicative and does not engage Modo Luce Srl, in any way or any form. Modo luce reserves the right to make any technical and aesthetical changes to models without prior notice, in compliance with the European standard.

The constant evolution and the continuous changes of the LED technology influence our products in a particular way. Modo Luce is always trying to identify the most up-to-date technical solutions in order to improve light quality and energy efficiency. Consequently, the datasheet shown in this catalogue may undergo variations. We advise you therefore to consult our website modoluce.com provided with the regularly updated technical data.

The CE mark is your assurance that the product meets all the requirements prescribed by law, as contained in the European Community directives which apply to the products.

Product colours can differ from what is shown in the catalogue and from batch to batch.

Certificati / Certifications

	Tutti i prodotti Modo Luce sono certificati CE / All the Modo Luce products are CE certified		Indica la possibilità di fornire il prodotto con certificazione ETL / Designates the possibility to have a wiring system with ETL certification
--	---	--	--

Legenda / Legend

	Indica il cablaggio elettrico CL1 / Designates the CL1 electric wiring		Curva fotometrica / Lighting data
	Indica il cablaggio elettrico CL2 / Designates the CL2 electric wiring		Comfort acustico / Acoustic comfort
	Indica che i materiali costituenti l'apparecchio superano la prova al filo incandescente alla temperatura indicata nell'icona secondo la norma IEC / Indique que les matériaux composant l'appareil passent le test au fil incandescent 650°, comme par règlement ICE 695-2-1		Modello depositato / Patent pending
	Dimmerabile / Dimmable		
	Cavo in acciaio ed elettrico a misura su richiesta / Metal and electrical wire on demand		

MODO LUCE SRL
via Venezia, 13
31028 Vazzola (TV) Italy

T +39 0438 488076
T +39 0438 488110
F +39 0438 488132

info@modoluce.com
modoluce.com

